

# ACTIVA



# ACTIVA



# Soluciones

Solutions/Des solutions/Soluções

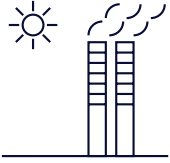

Cora Industry Lite 24



Pack CTE 30

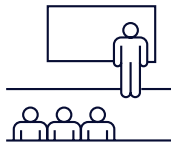

Pack Aulas/ Despachos 34



Pack Bluetooth 38

# Lámparas

Lamps/Lampes/Lâmpadas



icon Evo smart 46



icon Evo smart 47



icon basic 48



icon Mini basic 49



icon Par 20 smart 49



icon Par 20 smart 50



icon Par 30 smart 50



icon Par 38 smart 51



icon Par 38 IP65 smart 51



icon Par 56 smart 52



icon QR 111 smart 53



icon QR 111 smart 54



icon QR 111 basic 54

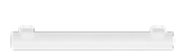

esSENSE Linestra smart 55



esSENSE Linestra nova 55



esSENSE Sofito smart 56



esSENSE Flame smart 57



esSENSE Flame basic 57



esSENSE BALL basic 58



esSENSE Standard smart 59



esSENSE Standard basic 12/24V 59



esSENSE Standard basic 60



esSENSE Globe smart 61



esSENSE Circle 62



fiSENSE Gold Drop smart 62



fiSENSE Gold Globe smart 63



fiSENSE smart 63



# Lámparas

Lamps/Lampes/Lâmpadas



True Colors Aluminium 66



True Colors PET 67



ecPOWER Compact smart 68



ecPOWER IP64 smart 69



ecPOWER smart 70



Tubular Mini smart 71



esSENSE Tubular smart 72



esSENSE R50 smart 74



esSENSE R63 smart 74



esSENSE R80 smart 75



esSENSE R90 smart 75



Spotcab smart 76



esSENSE Opal smart 77



esSENSE Opal smart 77



spotLINE 360° smart 78



spotLINE smart 79



Pebetero basic 80



esSENSE Compact smart 81



iconSTAR G4 smart 81



iconSTAR G9 smart 82



iconSTAR G9 basic 82



Accesorios 83

# Tubos

Tubes/Tubes/Tubos



ecTUBE T8 Glass smart 86



ecTUBE T8 Glass basic NR 87



ecTUBE T8 Glass eco NR 89

# Imagine: Tiras de led

Imagine: Led strips/Imagine: Bandes led/Imagine: Tiras de led



Imagine Rollo 24V 92



Imagine IP20 94



Imagine IP65 98



Imagine RGB 100



Imagine Rollo 230V 102



Proflex vacío 105



Accesorios 106

# Apliques Lineales

Linear appliques/Apliques linéaires/Apliques lineales



Softline 114



Bendline 115



Segmenta 116



Slimline Led Neo 117



Slimline Led Avant 118



Argos Led 119

# Downlights



Magnet 122



Favria 123



Viessa 124



Viessa Sensor 125



Kentau CL 128



Kentau SQ 130



Breno CL 132



Breno SQ 134



Breno CL basic 136



Breno PC 138



Norba 139



Navi 140



Nahe 141



Nahe 142

# Downlights



[DL 306](#) [144](#)



[DL 325](#) [144](#)



[Accesorios](#) [146](#)

# Pantallas

Screens/Des écrans/Paineis



[Rhoda](#) [150](#)



[Diane Superficie](#) [151](#)



[Diane Tech Switch Empotrar](#) [152](#)



[Diane Tech WAS](#) [154](#)



[Silent I UGR](#) [156](#)



[Etna Basic](#) [158](#)



[Etna Slim](#) [160](#)

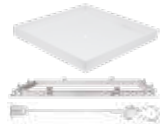

[Accesorios](#) [162](#)

# Solar



[Draco](#) [166](#)



[Kera](#) [168](#)























[Hadar](#) [169](#)



[Summet](#) [170](#)

# Green

						
Masne/ Masne Sensor 174	Anzio/ Anzio Sensor 176	Lucca/ Lucca Sensor 178	Merk 180	Hank 182	Arette Avant 183	Niza 184
						
Greco 187	Sura 188	Zinnia 189	Creus 190	Albir 192	Naxo 193	Catt 194
						
Pincho Jardin 195	Boiro II 196	Iseo 197	Agua Avant ABS 198	Hydra Avant 199	Accesorios 200	

# Proyectores

Projectors/Projecteurs/Projeteores

				
Chio Avant 204	Chio 206	Kenia/Kenia Sensor 208	Hitaka/Hitaka Sensor 210	Energy Tech HE 211
				
Energy Tech/Energy Tech Sensor 212	Energy Tech RGB RF 214	Accesorios 216		

# Industrial



Aken 220



Kela 222



Munich 225



Berlín Eco Tubo Led 226



Dácil 228



Dácil Switch 229



Dácil Switch Emergencia 230



Megara Avant 231



Accesorios 232

# Anexos

Annexes/Annexes/Anexos

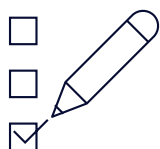

Certificaciones 236



Condiciones de Uso 236



Condiciones de Garantía 236



Condiciones de Venta 236

Leyenda/Legend/Légende/Legend

Producto **blue**.



# PRILUX

## Ñ

Prilux es una empresa con más de 35 años de experiencia en el sector de la iluminación. Focalizada en I+D+i, ayudamos a las empresas, instituciones y propiedad final a iluminar sus espacios a través de productos y soluciones tecnológicas fiables, innovadoras, personalizadas, escalables y de alto valor añadido.

Nuestro objetivo es ofrecer al sector soluciones de iluminación inteligente en todas las áreas mediante el uso de sistemas de control y regulación. Por esta razón desarrollamos tecnología propia que permite una gestión óptima del consumo, mejorar el confort y generar un importante ahorro económico de forma sostenible.

Personalización, flexibilidad, eficiencia y sostenibilidad son los valores que nos mueven a diseñar y fabricar luminarias y tecnología para nuestros clientes.

Somos una ingeniería de valor en proyectos de alumbrado público, industrial, deportivo, arquitectural y festivo/navideño.

## E

Prilux is a company with over 35 years' experience in the lighting sector. Focusing on R&D&i, we help companies, institutions and final owners light their spaces using reliable, innovative, customised, scalable technological products and solutions with high added value.

Our aim is to provide the sector with smart lighting solutions in all areas, making use of control and regulating systems. We develop our own technology for this reason, to enable optimal management of consumption, improve comfort and generate significant economic savings sustainably.

Customisation, flexibility, efficiency, and sustainability are values that drive us in designing and manufacturing luminaires and technology for our customers.

We are a value engineering company in public, industrial, sporting, architectural and festive/ Christmas lighting projects.



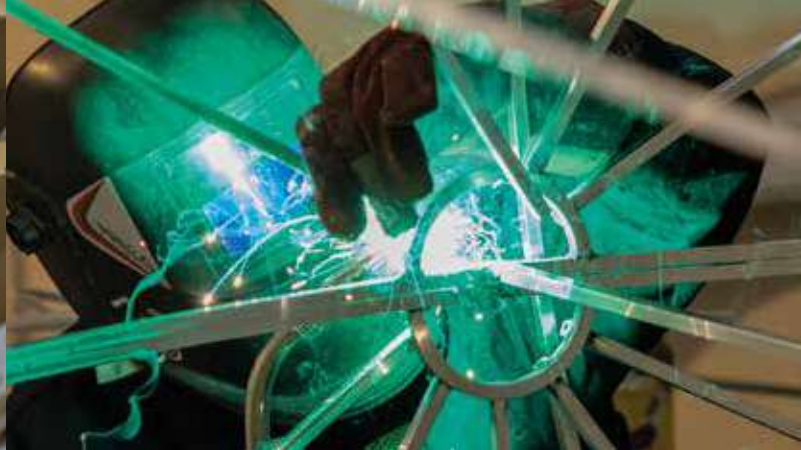

## F

Prilux est une entreprise qui jouit de plus de 35 ans d'expérience dans le secteur de l'éclairage. Axée sur la R+D+i, nous aidons les entreprises, les institutions et les propriétaires finaux à éclairer leurs espaces grâce à des produits et des solutions technologiques fiables, innovatrices, personnalisées, évolutives et à forte valeur ajoutée.

Notre objectif : proposer au secteur des solutions d'éclairage intelligent dans tous les domaines à l'aide de systèmes de contrôle et de régulation. C'est pour cette raison que nous développons notre propre technologie de sorte à permettre une gestion optimale de la consommation, à améliorer le confort et à donner lieu à une importante économie d'énergie de manière durable.

Personnalisation, souplesse, efficacité et durabilité sont les valeurs qui nous encouragent à concevoir et à fabriquer des luminaires et une technologie adaptés à nos clients.

Nous sommes une entreprise d'ingénierie de grande valeur, qui travaille sur des projets d'éclairage public, industriel, sportif, architectural et festif/de Noël.

## P

A Prilux é uma empresa com mais de 35 anos de experiência no setor da iluminação. Focada em I+D+i, ajudamos as empresas, instituições e proprietários finais a iluminar os seus espaços através de produtos e soluções tecnológicas fiáveis, inovadoras, personalizadas, escaláveis e de elevado valor acrescentado.

O nosso objetivo é oferecer ao setor soluções de iluminação inteligente em todas as áreas, recorrendo à utilização de sistemas de controlo e regulação. Por este motivo desenvolvemos tecnologia própria que permite uma gestão otimizada do consumo, melhorar o conforto e gerar uma significativa poupança económica de forma sustentável.

Personalização, flexibilidade, eficiência e sustentabilidade são os valores que nos motivam a conceber e fabricar luminárias e tecnologia para os nossos clientes.

Somos uma empresa de engenharia de valor em projetos de iluminação pública, industrial, desportiva, arquitetural e festiva/natalícia.

# Infraestructuras

Infrastructures

Infraestructuras

Infraestructuras

## Toledo

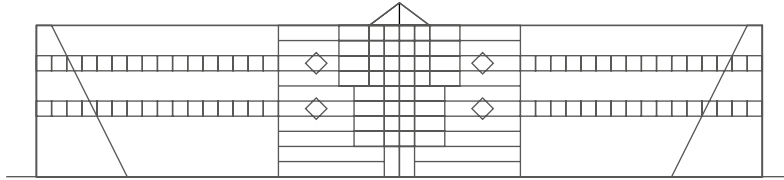

**16.500m<sup>2</sup>**

Almacén y centro productivo  
Warehouse & Production centre  
Stockage et centre de production  
Armazém e centro produtivo



**200m<sup>2</sup>**

Laboratorio  
Laboratories  
Laboratoires  
Laboratório



**300m<sup>2</sup>**

Salas limpias  
Clean rooms  
Salles blanches  
Salas limpas



**3.000m<sup>2</sup>**

Showrooms  
Showrooms  
Showrooms  
Showrooms

### Ñ

Con sede central en Toledo y delegación en Sant Llorenç d'Hortons (Barcelona), Prilux cuenta con modernas y amplias instalaciones que albergan espacios de oficina, conferencias, showrooms de exposición, laboratorio, almacenamiento, producción y salas limpias.

Además, nuestra delegación noreste actúa como plataforma logística para dar soporte al mercado internacional en Europa.

### E

With its headquarters in Toledo and branch in Sant Llorenç d'Hortons (Barcelona), Prilux has modern and extensive infrastructure housing storage, work and exhibition spaces such as: warehouses, production centres, laboratories, clean rooms, showrooms, training rooms and offices.

Also our northeast branch serves as a logistics platform for our expansion across Europe.



# Sant Llorenç d'Hortons (Barcelona)

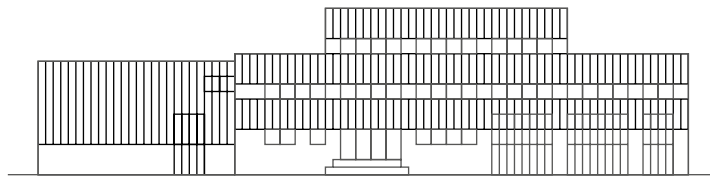

**13.000m<sup>2</sup>**

Almacén y centro productivo  
Warehouse & Production centre  
Stockage et centre de production  
Armazém e centro produtivo



**13**

Muelles de carga  
Loading bays  
Quais de chargement  
Cais de carga



**2.000m<sup>2</sup>**

Oficinas  
Offices  
Bureaux  
Escritórios



**2**

Showrooms  
Showrooms  
Showrooms  
Showrooms

## F

Le siège central de Prilux se trouve à Tolède et une antenne à Sant Llorenç d'Hortons (Barcelona), Prilux dispose d'infrastructures qui hébergent des espaces de stockage, de travail et d'exposition : entrepôts, centres de production, laboratoires, salles blanches, showrooms, salles de formation et bureaux.

De plus, notre délégation du Nord-est est une plate-forme logistique pour notre expansion en Europe.

## P

Com a sede central situada em Toledo e delegação em Sant Llorenç d'Hortons (Barcelona), Prilux dispõe de infraestruturas que compreendem espaços de armazenamento, trabalho e exposição como: armazéns, centros de produção, laboratórios, salas limpas, showrooms, salas de formação e escritórios.

Além disso, nossa delegação do noreste funciona como plataforma logística para a nossa expansão na Europa.

# Prilux around the world



Ñ

Tras 25 años centrados en el mercado español, exportamos principalmente a Europa, Europa del Este, Norte de África, Oriente Medio y América del Sur.

E

After 25 years focusing on the Spanish market, we export mainly to Europe, Eastern Europe, North Africa, the Middle East, South and America.

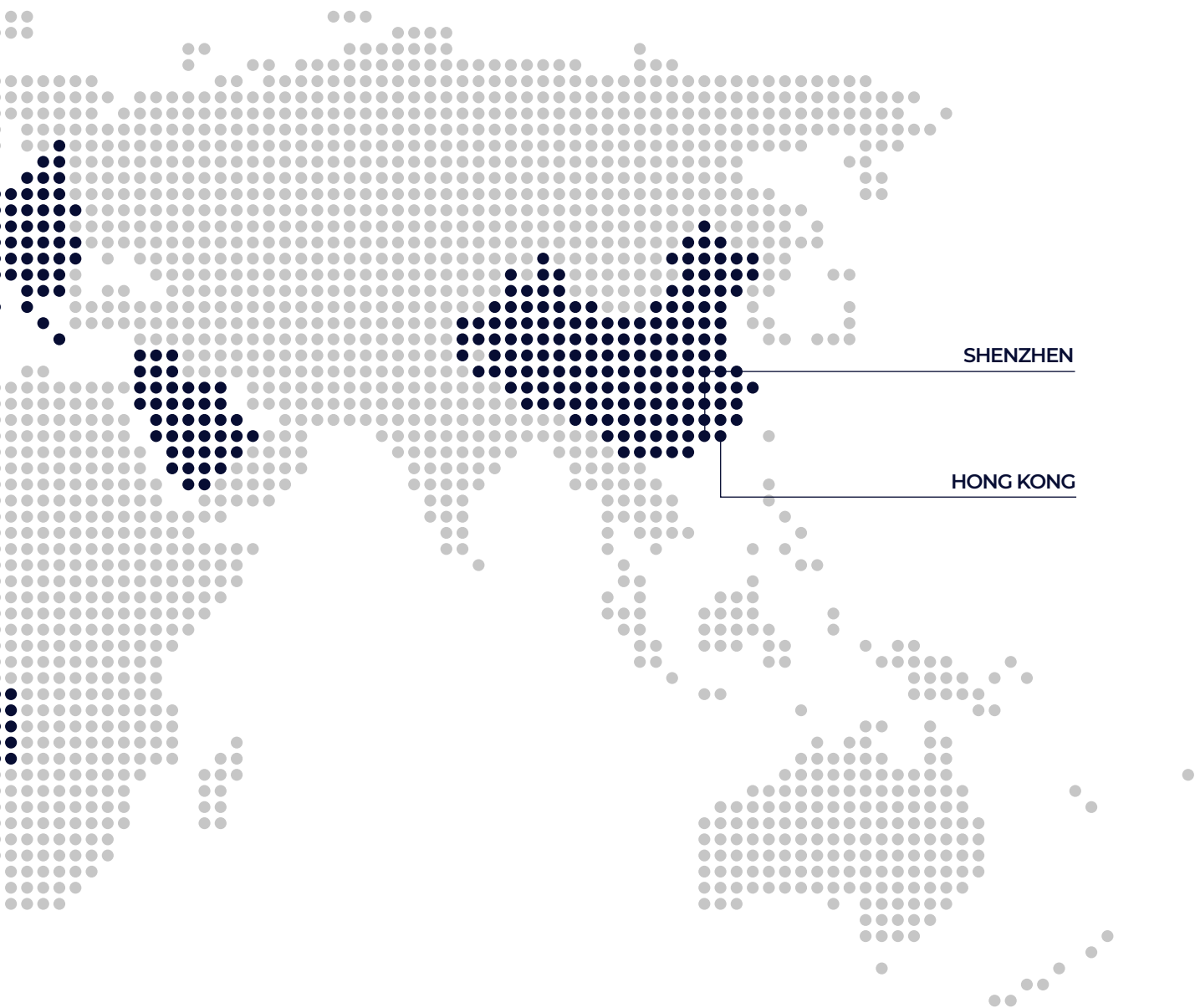

**F**

Après 25 ans centrés sur le marché espagnol, nous exportons principalement vers l'Europe, l'Europe de l'Est, l'Afrique du Nord, le Moyen Orient et l'Amérique du Sud

**P**

Após 25 anos concentrados no mercado espanhol, exportamos sobretudo para a Europa, Europa de Leste, Norte de África, Médio Oriente e América do Sul.

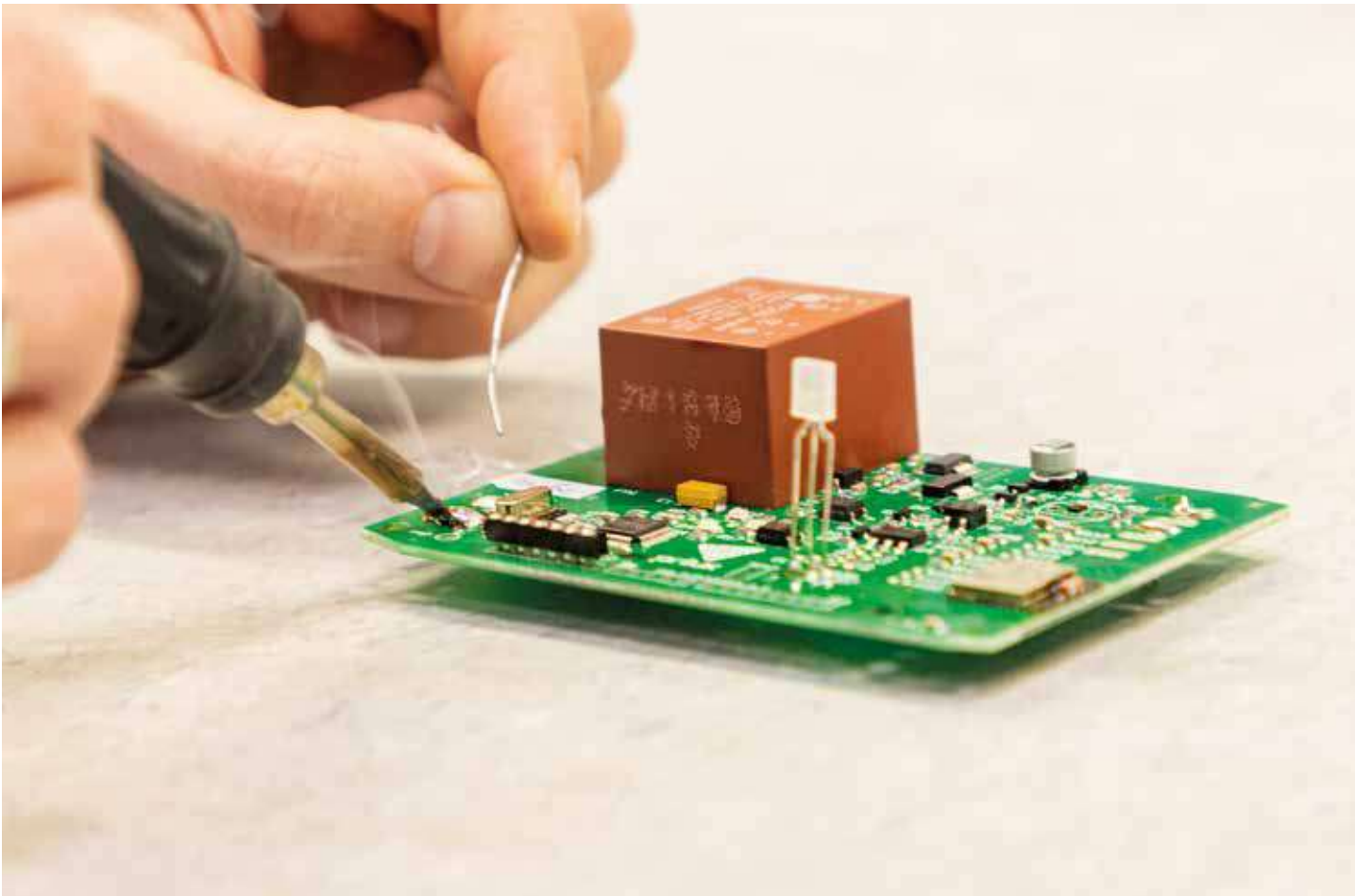

## I+D+i R&D&i

### Ñ

La innovación se ha convertido en una estrategia imprescindible para adaptarnos al mercado y su constante evolución. En Prilux apostamos por el futuro y nos apasiona diferenciar nuestros productos y soluciones explorando nuevos caminos a través de proyectos con varios horizontes temporales.

Trabajamos bajo softwares de última tecnología para mejorar la calidad de nuestros productos y adaptarnos a los cambios en el sector de forma ágil. Además, empleamos herramientas de simulación para predecir comportamientos y optimizar las soluciones.

### E

Innovation is strategic and essential for Prilux in its commitment to the future. At Prilux we are committed to the future and are passionate about differentiating our products and solutions by exploring new avenues in projects with varying timescales.

We work using state-of-the-art software to improve the quality of our products and adapt swiftly to changes in the sector. We also use simulation tools to predict behaviour and optimise solutions.

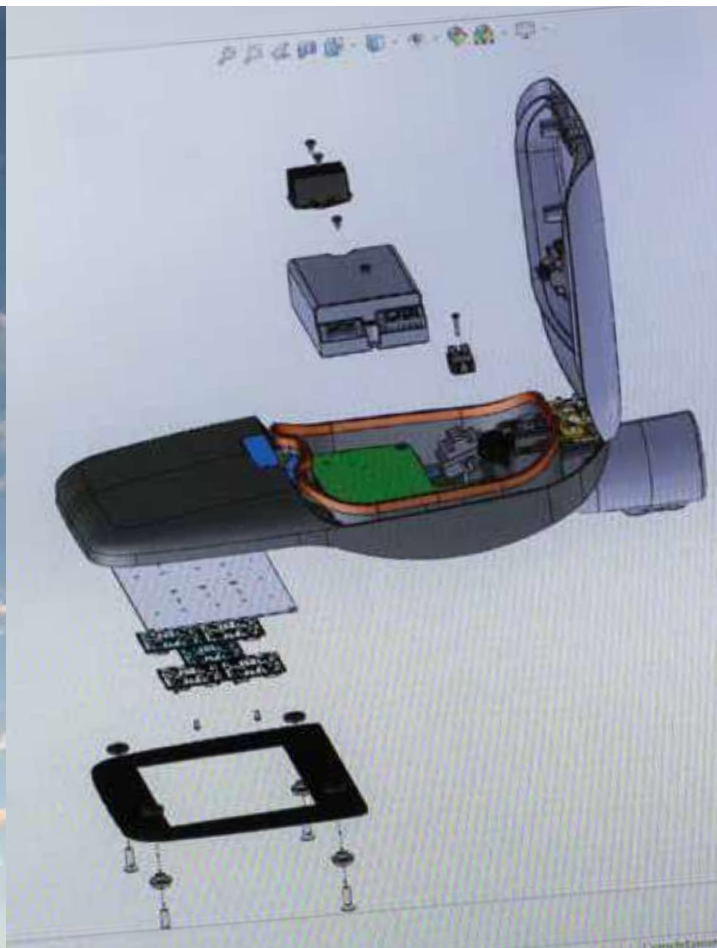

## F

Pour Prilux, l'innovation est stratégique et indispensable pour tenir notre pari sur l'avenir. Prilux mise sur l'avenir et n'a de cesse de différencier produits et solutions, et d'explorer de nouvelles voies à travers des projets s'étendant sur divers horizons de temps.

Nous travaillons avec des logiciels de pointe pour améliorer la qualité de nos produits et nous adapter avec souplesse aux changements que vit le secteur. Nous utilisons également des outils de simulation pour prédire les comportements et optimiser les solutions.

## P

A inovação para a Prilux é estratégica e indispensável ao apostar no futuro. Na Prilux apostamos no futuro e apaixonamos-nos a diferenciar os nossos produtos e soluções explorando novos caminhos através de projetos com vários horizontes temporais.

Trabalhamos com softwares de última geração para melhorar a qualidade dos nossos produtos e nos adaptarmos às mudanças no setor de forma ágil. Além disso, utilizamos ferramentas de simulação para prever comportamentos e otimizar as soluções.

# Producción y Calidad

Production and quality

Fabrication et Qualité

Produção e Qualidade

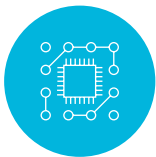

## Módulos LED propios

Own LED modules  
Modules LED propres  
Módulos LED próprios



## Control de calidad

Quality control  
Contrôle de qualité  
Controlo de qualidade



## Trazabilidad

Traceability  
Traçabilité  
Leitura



## Certificado ENEC (AENOR)

ENEC certification (AENOR)  
certificat ENEC (AENOR)  
certificado ENEC (AENOR)

## Ñ

Contamos con una “sala Blanca” equipada con una línea automática de montaje de componentes SMD (Serigrafía – Pick & Place – Horno) donde fabricamos todos nuestros módulos LED destinados a las soluciones lumínicas “made in Spain”.

Prilux dispone de un departamento de Calidad especializado tanto en la Calidad de Producto, como en el control de la Calidad Total empresarial que emplea la herramienta CERTOOL de AENOR para la gestión de la calidad y mejora continua de nuestros procesos. Este seguimiento permite ofrecer un servicio que cumpla con las especificaciones atribuidas en su totalidad.

Contamos con familias de productos con certificado ENEC, concedido por AENOR, que garantiza la calidad y seguridad de los productos, tanto en todo el proceso de fabricación, como cuando se introducen en el mercado.

## E

We have a “clean room” equipped with an automatic SMD component assembly line (Screen Printing – Pick & Place – Oven) where we manufacture all our LED modules for “made in Spain” lighting solutions.

Prilux has a Quality department specialising both in Product Quality and in corporate Total Quality control which uses AENOR’s CERTOOL tool for quality management and continuous improvement of our processes. This monitoring means it can offer a service that meets all attributed specifications in full.

We have product families with ENEC certification, granted by the Spanish standards organisation AENOR, guaranteeing product quality and safety, both throughout the manufacturing process and when they are placed on the market.





## F

Nous disposons d'une « salle blanche » équipée d'une ligne automatique de montage de composants SMD (sérigraphie - pick & place - four) où nous fabriquons tous nos modules LED destinés aux solutions d'éclairage « made in Spain ».

Prilux dispose d'un service qualité spécialisé aussi bien dans la qualité produit que dans le contrôle de la qualité intégrale de l'entreprise qui utilise l'outil AENOR CERTOOL pour la gestion de la qualité et l'amélioration continue de nos processus. Ce suivi permet de proposer un service répondant totalement aux spécifications attribuées.

Nous proposons des familles de produits certifiées ENEC, certification accordée par l'AENOR qui garantit la qualité et la sécurité des produits, aussi bien lors de l'ensemble du processus de fabrication que lors de leur mise sur le marché.

## P

Dispomos de uma “sala branca” equipada com uma linha automática de montagem de componentes SMD (Serigrafia – Pick & Place – Forno) onde fabricamos todos os nossos módulos LED destinados às soluções lumínicas “made in Spain”.

A Prilux possui um Departamento de Qualidade especializado tanto na Qualidade do Produto, como no controlo da Qualidade Total empresarial que utiliza a ferramenta AENOR CERTOOL para gestão da qualidade e melhoria contínua dos nossos processos. Este seguimento permite oferecer um serviço que cumpra as especificações atribuídas na sua totalidade.

Dispomos de famílias de produtos com certificado ENEC, concedido pela AENOR, que garante a qualidade e segurança dos produtos, tanto em todo o processo de fabrico como quando são introduzidos no mercado.

# Laboratorio

Laboratory

Laboratoire

Laboratório



Personalización  
Personalization  
Personnalisation  
Personalização



Goniofotómetro  
Goniophotometer  
Goniophotomètre  
Goniofotómetro



Ensayos IP / IK  
IP / IK Tests  
Essais IP / IK  
Ensaaios IP / IK



Esfera integradora  
Integrating sphere  
Sphère d'intégration  
Esfera integradora

## Ñ

Prilux dispone de laboratorio propio equipado con capacidad material y competencia técnica para realizar los ensayos de precertificación de luminarias según UNE-EN 60598 y fuentes de luz.

realizamos la caracterización de seguridad: durabilidad, calentamiento, IP, IK, dieléctricos...; eléctrica; fotométrica bajo EN 13032; espectral según CIE S-025 y TM30-15, con evaluación del cumplimiento de las directivas de protección del cielo; flicker según nueva regulación de ecodiseño; parámetros de Human Centric Lighting (HCL) y medidas para horticultura.

Para cubrir las demandas más exigentes llevamos a nuestras luminarias a situaciones extremas en términos de regulación, rangos de funcionamiento, altas temperaturas, congelación, conmutaciones y forzado de protecciones que se dan en situaciones reales.

Acompañamos al cliente en su necesidad de justificar el cumplimiento de los requisitos demandados por áreas de negocio o mercados como los árabes, industria alimentaria, HCL en el ámbito de educación, sanidad, geriatría, etc.

Llevamos a cabo las tareas de certificación con laboratorios y entidades acreditadas externas para conseguir los certificados de producto ENEC, CB, N, IAC, y asegurar el cumplimiento de los requisitos del CEI-IDAE vigentes.

## E

Prilux has its own laboratory equipped with the physical capability and technical competence to carry out pre-certification tests on luminaires under the UNE-EN 60598 standard and on light sources.

We perform characterisation of safety: endurance, thermal, ip, ik, dielectric...; electrical; photometric under EN 13032; spectral according to CIE S-025 and TM30-15, also evaluating compliance with directives on protection of the night sky; flicker according to new eco-design regulations; and human centric lighting (HCL) parameters and make measurements for horticulture.

To meet the most demanding requirements, we subject our luminaires to extreme conditions in terms of regulation, operating ranges, high temperatures, freezing, switching, and forcing of protections that occur in real situations. We work with our customers where they need to support compliance with requirements demanded by business sectors or markets, such as Arabian markets, the food industry, HCL in education, health care and geriatric fields, etc.

We conduct certification tasks with external laboratories and accredited entities to obtain ENEC, CB, N and Canary Islands Astrophysical Institute (IAC) product certificates and to ensure compliance with current Spanish Lighting Committee/Institute for Diversification and Saving of Energy (CEI-IDAE) requirements.





## F

Prilux dispose de son propre laboratoire doté de la capacité matérielle et de la compétence technique nécessaires pour procéder aux tests de pré-certification de luminaires selon la norme UNE-EN 60598 et sources lumineuses.

Nous réalisons la caractérisation de sécurité: endurance, chauffage, ip, ik, diélectriques... ; électrique ; photométrique selon la norme EN 13032 ; spectrale selon la norme CIE S-025 et TM30-15, avec évaluation de la conformité aux directives de protection du ciel ; flicker selon la nouvelle réglementation sur l'écoconception ; paramètres de human centric lighting (HCL) et prise de mesures pour l'horticulture.

Pour répondre aux demandes les plus exigeantes, nous soumettons nos luminaires à des situations extrêmes en termes de réglementation, fourchettes de fonctionnement, hautes températures, congélation, commutations et forçage de protections, comme dans les situations réelles. Nous accompagnons le client dans ses besoins de justification du respect des exigences posées par les différents domaines d'activité ou marchés, comme le marché arabe, l'industrie alimentaire, le HCL dans le domaine de l'éducation, la santé, la gériatrie, etc.

Nous nous livrons à des travaux de certification avec des laboratoires et établissements agréés externes pour obtenir les certificats de produits ENEC, CB, N, IAC et garantir le respect des exigences CEI-IDAE en vigueur.

## P

A Prilux dispõe de laboratório próprio equipado com capacidade material e competência técnica para realizar os ensaios de pré-certificação de luminárias segundo a UNE-EN 60598 e fontes de luz.

Realizamos a caracterização de segurança: resistência, aquecimento, ip, ik, dielétricos...; elétrica; fotométrica segundo a EN 13032; espectral segundo a CIE S-025 e TM30-15, com avaliação do cumprimento das diretivas de proteção do céu; flicker segundo a nova regulamentação de ecodesign; parâmetros de human centric lighting (HCL) e medidas para horticultura.

Para satisfazer as necessidades mais exigentes levamos as nossas luminárias a situações extremas em termos de regulação, faixas de funcionamento, altas temperaturas, congelamento, comutações e forçamento de proteções que ocorrem em situações reais. Acompanhamos o cliente na sua necessidade de comprovar o cumprimento dos requisitos exigidos por áreas de negócio ou mercados como os árabes, indústria alimentar, HCL no âmbito do ensino, saúde, geriatria, etc.

Realizamos as tarefas de certificação com laboratórios e entidades acreditadas externas para obter os certificados de produto ENEC, CB, N, IAC, e garantir o cumprimento dos requisitos do CEI-IDAE em vigor.

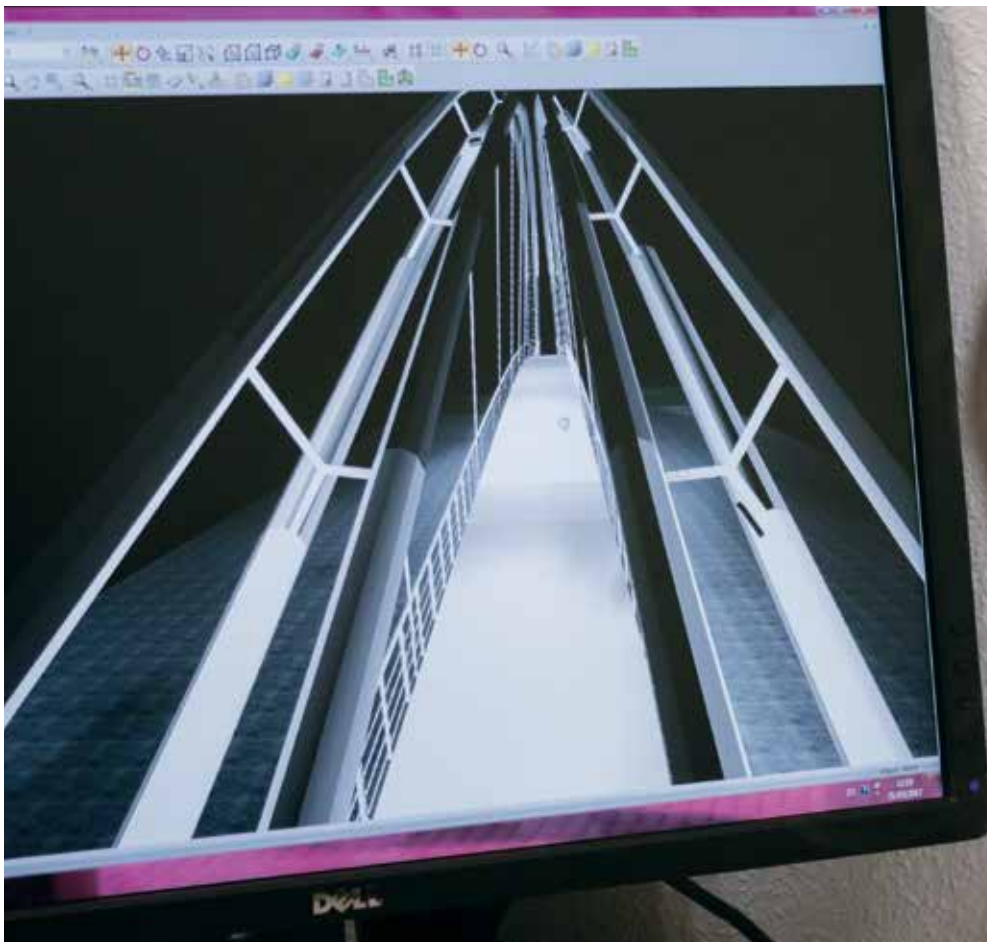

# Proyectos

## Projets / Projets / Projetos

### Ñ

Para las obras con mayores exigencias técnicas ponemos a disposición de nuestros clientes el departamento de proyectos, en el cual se estudian y diseñan soluciones lumínicas a través de software específico para ello.

Actualmente disponemos de soluciones tecnológicas de iluminación con sistemas de control integrados según demanda para la industria, oficinas, alumbrado público y vial, tiendas de retail, supermercados y centros comerciales, aplicaciones deportivas, parkings, hoteles, hospitales, colegios y universidades... Aportamos soluciones de iluminación creativas, personalizadas y adaptadas a las necesidades de nuestros clientes y ajustadas a la norma con un enfoque particular hacia el bienestar humano y la eficiencia energética.

### E

For projects of major technical demand we provide our clients with access to the projects' department, which studies and designs lighting solutions by means of software specifically tailored for this purpose.

At present we provide on-demand lighting technological solutions with integrated control systems for industrial facilities, offices, public and street lighting, retail stores, supermarkets and shopping centres, sport facilities, car parks, hotels, hospitals, schools and universities... We offer creative, customised lighting solutions adapted to the needs of our clients and in compliance with regulations, with a particular focus on human welfare and energy efficiency.



## F

Pour les travaux présentant des exigences techniques plus importantes, nous mettons à disposition de nos clients le département de projets, où les solutions d'éclairage sont étudiées et conçues grâce à un logiciel spécifique.

Nous disposons actuellement de solutions technologiques d'éclairage avec des systèmes de contrôle intégrés en fonction de la demande pour l'industrie, bureaux, l'éclairage public et routier, boutiques de vente au détail, supermarchés, centres commerciaux, applications sportives, parkings, hôtels, hôpitaux, écoles et universités... Nous fournissons des solutions d'éclairage créatives, personnalisées et adaptées aux besoins de nos clients, mais aussi conformes à la réglementation, avec une approche particulière focalisée sur le bien-être humain et l'efficacité énergétique.

## P

Para as obras com maiores exigências técnicas colocámos á disposição dos nossos clientes o nosso departamento de projectos, no qual se estudam e desenham soluções luminicas através de software específico para o efeito.

Actualmente dispomos de soluções tecnológicas de iluminação com sistemas de controlo integrados a pedido para a indústria, escritórios, iluminação pública e viária, lojas de retalho, supermercados e centros comerciais, aplicações desportivas, parques de estacionamento, hotéis, hospitais, escolas e universidades... Temos soluções de iluminação criativas, personalizadas e adaptadas às necessidades dos nossos clientes e ajustadas á norma com um foco particular no bem estar do ser humano e na eficiência energética.



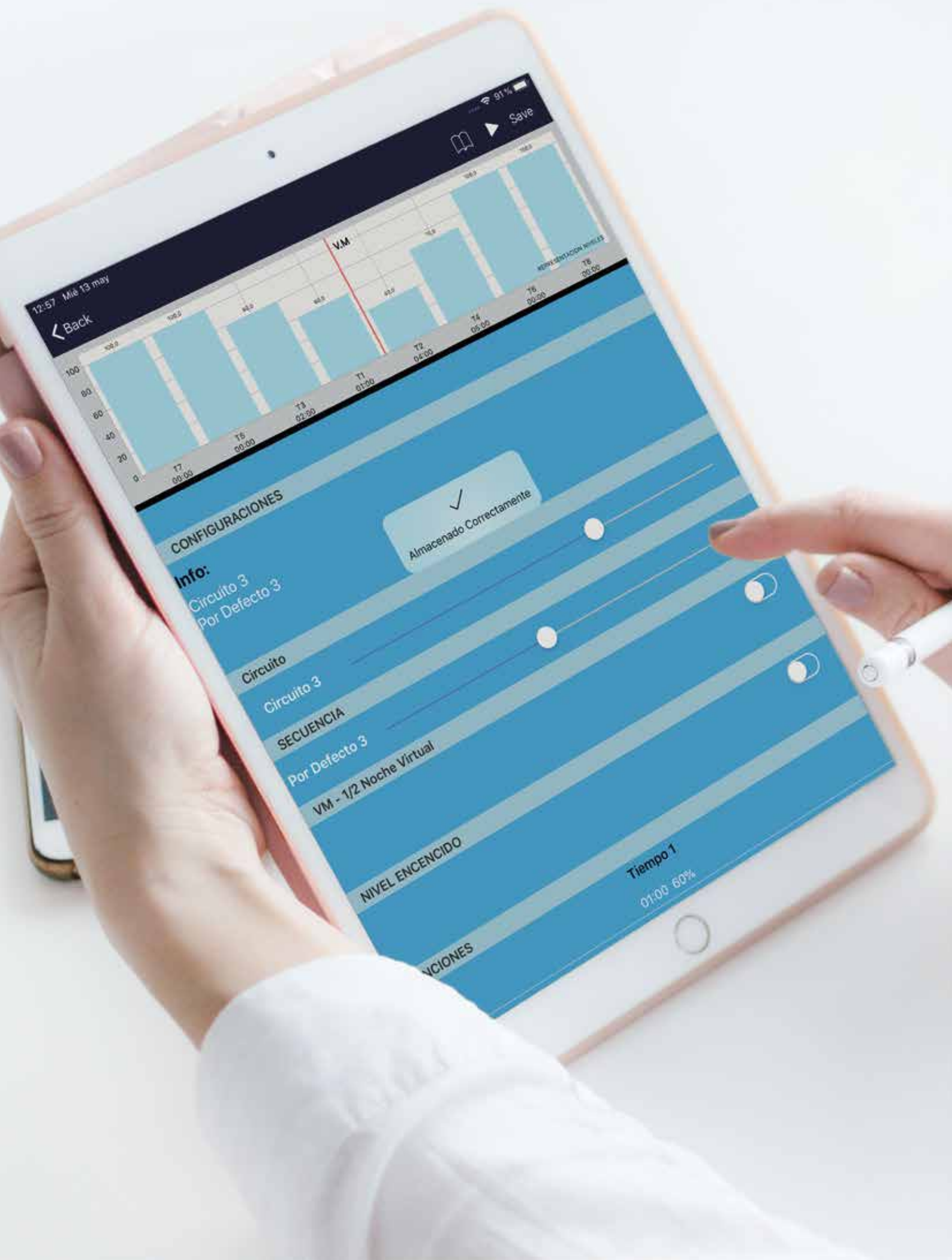

12:57 Mie 13 may

Back

Save

### CONFIGURACIONES

✓  
Almacenado Correctamente

Info:  
Circuito 3  
Por Defecto 3

Circuito

Circuito 3

SECUENCIA

Por Defecto 3

VM - 1/2 Noche Virtual

NIVEL ENCENDIDO

Tiempo 1

01:00 60%

ACIONES

Soluciones  
Solutions  
Des solutions  
Soluções

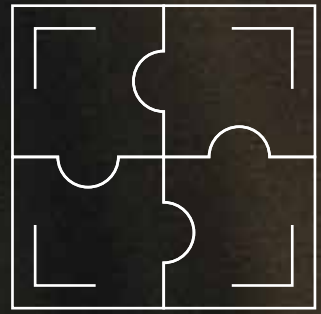

# CORA INDUSTRY LITE



## Ñ

Cora Industry LITE es el nuevo sistema de control lumínico autónomo perfecto para cualquier instalación industrial. Con una instalación sencilla, rápida e intuitiva, Cora Industry Lite supone un giro en la evolución de la industria aportando renovación, control y una completa gestión del alumbrado en fábricas y almacenes.

Dispone de sensor de luz integrado, regula el flujo emitido por las luminarias compensando el aporte de luz natural y consigue un aprovechamiento óptimo de la energía al monitorizar, de forma permanente, el nivel de luz ajustando la regulación de las luminarias hasta los niveles fijados

## F

Cora Industry LITE est le nouveau système de contrôle lumineux autonome parfait pour n'importe quelle installation industrielle. D'installation simple, rapide et intuitive, Cora Industry Lite marque un tournant dans l'évolution de l'industrie en apportant modernisation, contrôle et gestion intégrale de l'éclairage dans les usines et les entrepôts.

Il dispose d'un capteur de lumière intégré et régule le flux émis par les luminaires en compensant l'apport de lumière naturelle. En outre, il optimise l'utilisation de l'énergie en contrôlant en permanence le niveau de lumière grâce au réglage des luminaires aux niveaux fixés.

## E

Cora Industry LITE is the new standalone lighting control system, which is ideal for any industrial installation. With simple, quick, intuitive installation, Cora Industry Lite represents a turning point in development in the industry, providing renewal, control and full management of lighting in factories and warehouses.

It has a built-in light sensor, regulates the flux emitted by the luminaires to compensate for the contribution from natural light and achieves optimal energy use by continually monitoring the light level to adjust the luminaires to the levels set.

## P

Cora Industry LITE é um novo sistema de controlo lumínico autónomo perfeito para qualquer instalação industrial. Com uma instalação simples, rápida e intuitiva, Cora Industry Lite representa um ponto de viragem na evolução da indústria, proporcionando renovação, controlo e uma completa gestão da iluminação em fábricas e armazéns.

Dispõe de sensor de luz integrado, regula o fluxo emitido pelas luminárias compensando o aporte de luz natural e consegue um aproveitamento ótimo da energia ao monitorizar permanentemente o nível de luz, ajustando a regulação das luminárias até aos níveis fixados







# Funcionalidades

Functionalities / Fonctionnalités / Funcionalidades



## Control eficiente de la instalación

Efficient facility control  
Contrôle efficient de l'installation  
Controlo eficiente da instalação

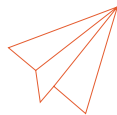

## Instalación sencilla e intuitiva

Simple, intuitive installation  
Installation simple et intuitive  
Instalação simples e intuitiva



## Sistema autónomo de control

Standalone control system  
Système de contrôle autonome  
Instalação simples e intuitiva



## Regulación precisa DALI Broadcast de hasta 64 drivers.

Precise DALI Broadcast regulation of up to 64 drivers  
Régulation précise DALI Broadcast allant jusqu'à 64 drivers.  
Regulación precisa DALI Broadcast de hasta 64 drivers.



## Configuración directa del nivel de luz mediante pulsador.

Direct light level setting by push button  
Configuration directe du niveau de lumière par bouton.  
Configuración directa del nivel de luz mediante pulsador.

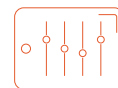

## Configuración avanzada desde la aplicación iOS Play LITE

Advanced setting from the iOS Play LITE app  
Configuration avancée à partir de l'application iOS Play LITE  
Configuración avanzada desde la aplicación iOS Play LITE





## Cora Industry LITE /

Iluminación de nave industrial  
 Industrial building lighting  
 Éclairage de bâtiment industriel  
 Iluminação de edifícios industriais

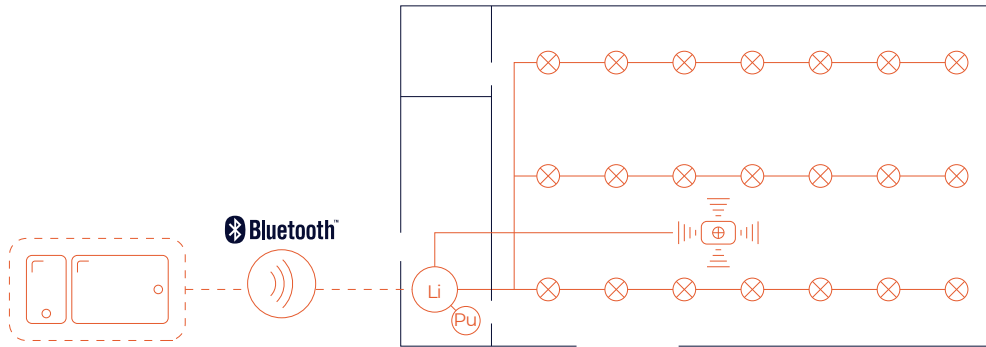

**Ñ:** Entre sus características intrínsecas principales, destaca la configuración del nivel de luz mediante un pulsador sin necesidad de instalar ningún tipo de software, a excepción de configuraciones avanzadas como la posibilidad de incorporar redes de detección de presencia a través de la app IOS Play LITE.

**E:** Outstanding among its main intrinsic features is push button light level setting with no need to install any software, except for advanced settings such as the ability to incorporate presence detection networks via the IOS Play LITE app.

**F:** La configuration du niveau de lumière grâce à un bouton ne nécessitant aucune installation de logiciel, à l'exception des configurations avancées comme la possibilité d'incorporer des réseaux de détection de présence à travers l'application IOS Play LITE, fait partie de ses principales caractéristiques intrinsèques.

**P:** Entre as suas principais características intrínsecas, destaca-se a configuração do nível de luz através de um botão sem necessidade de instalar qualquer tipo de software, exceto configurações avançadas, como a possibilidade de integrar redes de detecção de presença através da app IOS Play LITE.



**Luxómetro integrado**  
 Integrated luxometer  
 Luxomètre intégré  
 Luxómetro integrado

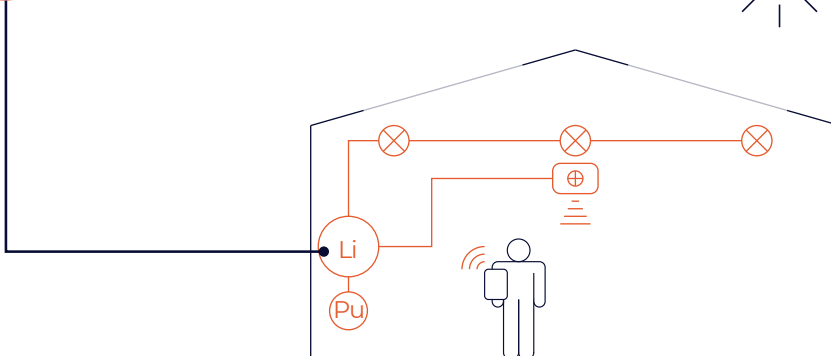



## Kela



## Dacil Switch



AVISO / WARNING / AVERTISSEMENT / AVISO



Las soluciones Pack CTE son de aplicación exclusivas en luminarias provistas de sistema DALI.

CTE Pack solutions apply exclusively to luminaires equipped with a DALI system.

Les solutions CTC appliquent exclusivement aux luminaires équipés d'un système DALI.

As soluções da Pack CTE aplicam-se exclusivamente a luminárias equipadas com um sistema DALI.

# Pack CTE

Luz natural DALI

DALI Daylight

lumière naturelle DALI

Luz natural DALI

---



## Ñ

Regulación por aporte de luz natural para cumplir con las exigencias del CTE.

Control independiente de dos líneas de luminarias regulables DALI con sensor para instalar en luminaria o caja en superficie. Preconfigurado para poner en funcionamiento de manera sencilla. (Máximo 10 luminarias).

## F

Régulation en fonction de l'apport de lumière naturelle, pour répondre aux exigences du code technique de la construction (CTC).

Contrôle indépendant de deux lignes de luminaires réglables DALI, avec capteur à installer sur luminaire ou dans un boîtier en surface. Préconfiguré pour être mis en service de forme simple. (Maximum 10 luminaires).

## E

Daylight harvesting in compliance with the CTE requirements.

Separate control of the two DALI light lines with a sensor to install in the lights or in a box at floor level. Pre-configured to turn on easily. (Maximum 10 luminaires).

## P

Regulação por entrada de luz natural para cumprir com as exigências do CTE.

Control independente de duas linhas de luminárias reguláveis DALI com sensor para instalar na luminária ou em caixa de superfície. Pré-configurado para poder colocar em serviço de modo facilitado. (Máximo de 10 luminárias).





# Funcionalidades

## Functionalities / Fonctionnalités / Funcionalidades



Sistema de control digital DALI para control por presencia y regulación por aporte de luz natural. Control manual por pulsador (no hay límite de pulsadores en paralelo).

Digital DALI control system for presence control adjustable based on the contribution of natural light Manual control with a switch (with no limit on parallel switches).

Système de contrôle numérique DALI pour le contrôle en fonction de la présence et la régulation conformément à l'apport de lumière naturelle. Contrôle manuel moyennant bouton (sans limite de boutons en parallèle).

Sistema de control digital DALI para control por presença e regulação por entrada de luz natural. Control manual por botão de pressão (não há limites para botões de pressão em paralelo).

Luminosidad a través de multisensor con rango 10–650lx, orientado al plano de referencia y no a la entrada de luz.

Lighting from a multi-sensor with a range of 10–650lx focused on the reference plane and not on the entrance of the light.

Luminosité par l'intermédiaire de multi-capteur d'intervalle 10–650 lx, orienté vers le plan de référence et non vers l'entrée de lumière.

Luminosidade através de multisensor com gama de 10–650lx, orientado para o plano de referência e não para a entrada de luz.

Detección de presencia a través del multisensor incorporado.

Presence detection with an integrated multi-sensor

détection de présence grâce au multi-capteur incorporé.

Detecção de presença através do multisensor incorporado.



Múltiples opciones configurables: nivel secundario cuando no haya detección de presencia, desfase de niveles entre los dos grupos, apagado por exceso, actuación en caso de rearme, regulación manual, control independiente entre grupos control por mando IR a distancia...

Multiple configurable options: secondary level if no presence detected, level offset between the two groups, turns off due to excess, turns on if rearmed, manual adjustment, separate control between control groups with remote IR control

Multiples options de configuration: niveau secondaire lorsque aucune présence n'est détectée, décalage de niveaux entre les deux groupes, extinction en raison d'un excès, action en cas de réarmement, régulation manuelle, contrôle indépendant entre groupes de contrôle par commande IR à distance...

Múltiplas opções configuráveis: nível secundário quando não exista deteção de presença, desfasamento de níveis entre os dois grupos, desligar por excesso, atuação em caso de rearme, regulação manual, control independente entre grupos control por comando IR a distância...

Es posible conectar amplificadores DALI a la salida de control para ampliar en hasta 64 luminarias por amplificador y hasta 300m de longitud.\*

DALI amplifiers can be connected to the control output to increase the light up to 64 lumen with an amplifier and up to a length of 300m.\*

Il est possible de connecter des amplificateurs DALI à la sortie de contrôle pour élargir jusqu'à 64 luminaires par amplificateur et jusqu'à 300m de longueur.\*

É possível ligar amplificadores DALI à saída de control para ampliar até 64 luminárias por amplificador e até 300mt de comprimento.\*

### \*NOTA / NOTE:

Conectar amplificadores implica que un gran número de luminarias actuarán de la misma manera, con la misma medición de aporte de luz natural, y esto, normalmente, no es la manera de regular más eficiente ni la más precisa.

Connecting amplifiers means that a large number of lights will act in the same way, with the same measurement of additional natural light, and this is usually not the most efficient or appropriate method.

Connecter des amplificateurs implique qu'un grand nombre de luminaires fonctionne de la même manière, avec la même mesure d'apport de lumière naturelle, et ceci n'est pas normalement la forme de régulation la plus efficace et la plus précise.

Ligar amplificadores implica que um grande número de luminárias atuarão da mesma maneira, com a mesma medição de entrada de luz natural, e isto, normalmente, não é a maneira de regular mais eficiente nem a mais precisa.

### Kentau CL / Kentau SQ \*



### Breno CL / Breno SQ \*



### Diane Tech Switch \*

Empotrar / Recessed / Encastré / Recesso



### Diane Tech WAS

Empotrar / Recessed / Encastré / Recesso



### Silent I UGR \*

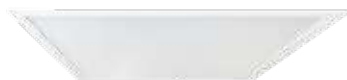

### Etna Basic \*



### Etna Slim \*



\* Bajo pedido  
On request  
Sur commande  
A pedido

AVISO / WARNING / AVERTISSEMENT / AVISO



Las soluciones Pack CTE son de aplicación exclusivas en luminarias provistas de sistema DALI.

CTE Pack solutions apply exclusively to luminaires equipped with a DALI system.

Les solutions CTC appliquent exclusivement aux luminaires équipés d'un système DALI.

As soluções da Pack CTE aplicam-se exclusivamente a luminárias equipadas com um sistema DALI.

# Pack Aula/Despachos

Classroom/Offices Pack

Pack Salle de Cours/Bureau

Pack Sala de Aula/Escritórios



## Ñ

Regulación por aporte de luz natural y presencia stand alone.

Sistema de control de iluminación para cumplir con las exigencias del CTE y optimizar el uso de la energía aprovechando el aporte de luz natural y apagado automático en caso de ausencia.

Control independiente de dos líneas de luminarias regulables DALI y una tercera línea ON-OFF. (Máximo 20 luminarias).

## F

Réglage en fonction de l'apport de lumière naturelle et de la présence stand alone.

Système de contrôle de l'éclairage pour répondre aux exigences du code technique de la construction (CTC) et optimiser l'utilisation de l'énergie en profitant de l'apport de lumière naturelle et de l'extinction automatique en cas d'absence.

Contrôle indépendant de deux lignes de luminaires réglables DALI et d'une troisième ligne ON-OFF. (Maximum 20 luminaires).

## E

Daylight harvesting and presence detection stand alone system.

A system to control lighting to meet CTE requirements and optimise energy use by taking advantage of natural light and automatic shut-off in the case of absence.

Independent control of two adjustable DALI lighting lines and a third on/off line. (Maximum 20 luminaires).

## P

Regulação por entrada de luz natural e presença "stand alone".

Sistema de control de iluminação para cumprir com as exigências do CTE e otimizar o uso da energia aproveitando a entrada de luz natural e desligar automaticamente em caso de ausência. Control independente de duas linhas de luminárias reguláveis DALI e uma terceira linha ON-OFF. (Máximo de 20 luminárias).





# Funcionalidades

## Functionalities / Fonctionnalités / Funcionalidades

DALI



Sistema de control digital DALI para control por presencia y regulación por aporte de luz natural.

Digital DALI control system for presence control adjustable based on the contribution of natural light

Système de contrôle numérique DALI pour le contrôle en fonction de la présence et le réglage conformément à l'apport de lumière naturelle.

Sistema de control digital DALI para control por presença e regulação por entrada de luz natural.

Funcionamiento automático y control manual por pulsador (Sin limite de pulsadores en paralelo).

Automatic on/off and manual control with a switch (with no limit on parallel switches).

Fonctionnement automatique et contrôle manuel moyennant bouton (sans limite de boutons en parallèle).

Funcionamento automático e control manual por botão de pressão (Sem limite de botoões de pressão em paralelo).

Detección de presencia a través del multisensor incorporado.

Presence detection with an integrated multi-sensor

détection de présence grâce au multi-capteur incorporé.

Detecção de presença através do multisensor incorporado.

Luminosidad a través de multisensor con rango 10–650lx, orientado al plano de referencia y no a la entrada de luz.

Lighting from a multi-sensor with a range of 10–650lx focused on the reference plane and not on the entrance of the light.

Luminosité par l'intermédiaire de multi-capteur d'intervalle 10–650 lx, orienté vers le plan de référence et non vers l'entrée de lumière.

Luminosidade através de multisensor com gama de 10–650lx, orientado para o plano de referência e não para a entrada de luz.



- Múltiples opciones configurables:
  - Nivel secundario cuando no haya detección de presencia
  - Desfase de niveles entre los dos grupos,
  - Apagado por exceso
  - Actuación en caso de rearme.
  - Regulación manual
  - Control independiente entre grupos control por mando IR a distancia...
- Multiple configurable options:
  - Secondary level if no presence detected
  - Level offset between the two groups
  - Turns off due to excess
  - Turns on if rearmed.
  - Manual adjustment
  - Separate control between control groups with remote IR control...

- Multiples options de configuration:
  - Niveau secondaire lors que aucune présence n'est détectée.
  - Décalage de niveaux entre les deux groupes.
  - Extinction en raison d'un excès.
  - Action en cas de réarmement.
  - Régulation manuelle
  - Contrôle indépendant entre groupes de contrôle par commande IR à distance...
- Múltiplas opções configuráveis:
  - Nivel secundário quando não exista deteção de presença
  - Desfasamento de nível entre os dois grupos,
  - Desligado por excesso
  - Actuação no caso de rearme.
  - Regulação manual
  - Control independente entre grupos de control por comando IR à distância...

### Kentau CL / Kentau SQ \*



### Breno CL / Breno SQ \*



### Diane Tech Switch \*

Empotrar / Recessed / Encastré / Recesso



### Diane Tech WAS

Empotrar / Recessed / Encastré / Recesso



### Silent I UGR \*

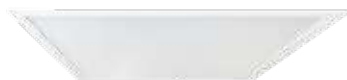

### Etna Basic \*



### Etna Slim \*



\* Bajo pedido  
On request  
Sur commande  
A pedido

AVISO / WARNING / AVERTISSEMENT / AVISO



Las soluciones Pack Aula / Depachos son de aplicación exclusivas en luminarias provistas de sistema DALI.  
Classroom/Offices Pack solutions apply exclusively to luminaires equipped with a DALI system.  
Les solutions Pack Salle de Cours/Bureau appliquent exclusivement aux luminaires équipés d'un système DALI.  
As soluções da Pack Sala de Aula/Escritórios aplicam-se exclusivamente a luminárias equipadas com um sistema DALI.

# Versión BLUETOOTH

## BLUETOOTH pack



# CASAMBI

### Ñ

Versión de nuestras luminarias con comunicación Bluetooth Casambi que a través de cualquier terminal Bluetooth® vía APP gratuita nos ofrece el control de regulación de flujo, color, configuración de escenas, comportamiento vinculado a horarios. Múltiples accesorios pueden configurarse para funcionar en la misma red para unificar el control de uno o varios espacios, siendo posible crear grupos, escenas y secuencias dinámicas a medida. El dispositivo Bluetooth® es válido para cualquier luminaria DALI.

### F

Version de nos luminaires avec communication Bluetooth Casambi qui via n'importe quel terminal Bluetooth® via APP gratuite qui offre le contrôle de la régulation de flux, la couleur, la configuration de la scène, le comportement lié aux horaires. Plusieurs accessoires peuvent être configurés pour travailler sur le même réseau pour unifier le contrôle d'un ou plusieurs espaces, être capable de créer des groupes, des scènes et des séquences dynamiques à mesurer. L'appareil Bluetooth® est valable pour tout luminaire DALI.

### E

Casambi version of our fixtures that enables through any Bluetooth® terminal via free APP that offers the control of flow regulation, color, scene configuration, behavior linked to schedules. Multiple accessories can be configured to work on the same network to unify the control of one or more spaces, being able to create groups, scenes and dynamic sequences to measure. The Bluetooth® device is valid for any DALI luminaire.

### P

Versão das nossas luminárias com comunicação Bluetooth Casambi que através de qualquer terminal Bluetooth...® via aplicativo gratuito que oferece o controle de regulação de fluxo, cor, configuração de cena, comportamento vinculado a agendas. Vários acessórios podem ser configurados para trabalhar na mesma rede para unificar o controle de um ou mais espaços, podendo criar grupos, cenas e sequências dinâmicas para medir. O dispositivo Bluetooth® é válido para qualquer luminária DALI.





# Funcionalidades

## Functionalities / Fonctionnalités / Funcionalidades



Accesorio que habilita el control inalámbrico de luminarias regulables. Posibilidad de conexión a internet de las redes para su control telepático mediante pasarela externa.

Accessory that enables the wireless control of dimmable luminaires. Possibility of connecting networks to Internet for telematic control through an external gateway.

Accessoire qui permet la commande sans fil des luminaires dimmable. Possibilité de connecter les réseaux à Internet pour un contrôle télématique via une passerelle externe.

Acessório que permite o controle sem fio de luminárias dimmable. Possibilidade de conectar as redes à Internet para controle telemático através de um gateway externo.



Un dispositivo por luminaria que permite creación de grupos, escenas, dinamis-mos...

A device for luminaires that allows the creation of groups, scenes, dynamisms...

Un dispositif pour luminaires qui permet la création de groupes, scènes, dynamismes...

Um dispositivo para luminárias que permite a criação de grupos, cenas, dinamismos...



Integrable en redes de control Bluetooth a través de app gratuita Casambi.

Integrated in Bluetooth control networks via free Casambi app.

Intégré dans les réseaux de contrôle Bluetooth via l'appli Casambi gratuite.

Integrado em redes de controle Bluetooth via app Casambi livre.



Dispositivo controlable de manera remota con Smartphone o Tablet Android/iOS.

Remotely controllable device with Smartphone or Android/iOS Tablet.

Appareil contrôlable à distance avec smartphone ou tablette Android/iOS..

Dispositivo remotamente controlável com smartphone ou Android/iOS Tablet.



Sin necesidad de una pasarela u otros dispositivos externos.

Without the need for a walkway or other external devices.

Sans besoin d'une passerelle ou d'autres appareils externes.

Sem a necessidade de uma passarela ou outros dispositivos externos.



Establece automáticamente una red de comunicaciones inalámbrica con un máximo de 127 nodos.

It automatically establishes a wireless communications network with a maximum of 127 nodes.

Il établit automatiquement un réseau de communications sans fil avec un maximum de 127 nœuds.

Ele estabelece automaticamente uma rede de comunicações sem fio com um máximo de 127 nós.



Las actualizaciones de firmware pueden efectuarse, sin conexión por cable, con cualquier dispositivo Android o iOS.

Firmware upgrades can be done without cable connection with any Android device or IOS

Les mises à niveau du firmware peuvent être effectuées sans connexion par câble avec un appareil Android ou IOS.

Upgrades de firmware pode ser feito sem conexão a cabo com qualquer dispositivo Android ou IOS



Fácil implementación de regulaciones de RGB y temperatura del color.

Easy implementation of RGB and color temperature regulations.

Mise en œuvre aisée des réglémentations RVB et de la température des couleurs.

Fácil implementação de regulamentos de temperatura de cor e RGB



Hasta 15m de alcance.

Up to 15m of range.

Jusqu'à 15m de portée.

Até 15m de alcance.

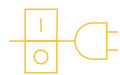

Posibilidad de controlar la alimentación del driver mediante relé.

Possibility of controlling the power of the driver by means of a relay.

Possibilité de contrôler la puissance du conducteur au moyen d'un relais.

Possibilidade de controlar o poder do condutor por meio de um relé.



Salida digital: Compatible con DALI autónomo. Salida analógica: Compatible con 1-10V

Digital output: Compatible with stand-alone DALI. Analogic output: Compatible with 1-10V.

Sortie numérique: compatible avec DALI autonome. Sortie analogique: 1-10V conforme

Saída digital: Compatível com DALI autónomo. Saída analógica: Compatível com 1-10V



Versões com envoltório para uso interior (454230) y exterior (550994)

Versions with enclosure for interior use (454230) and exterior (550994)

Versions avec boîtier pour usage intérieur (454230) et extérieur (550994)

Versões com invólucro para uso interior (454230) e exterior (550994)

PUNCH  
TODAY  
IN THE  
FACE.

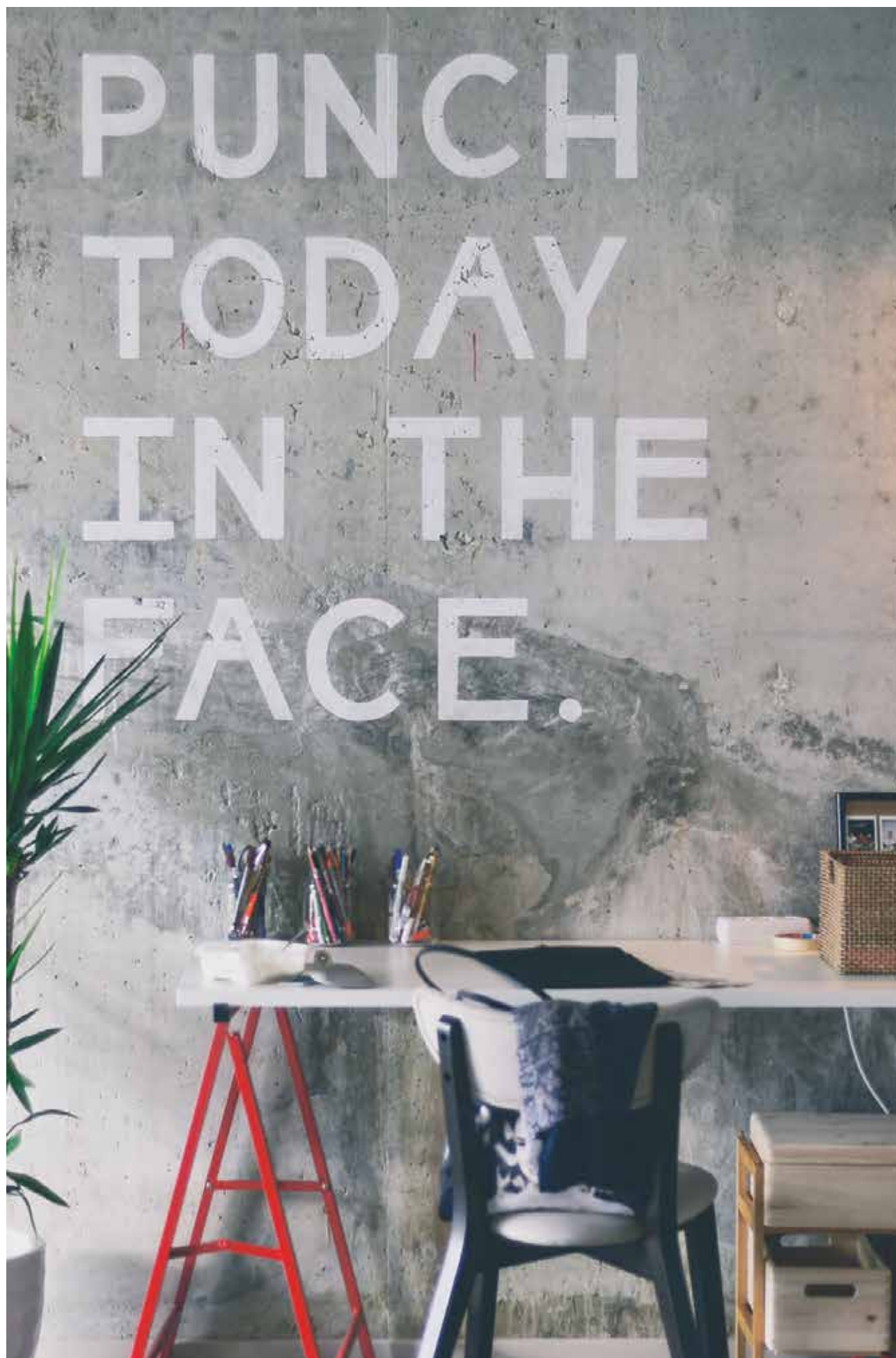

### Kentau CL / Kentau SQ \*



### Breno CL / Breno SQ \*



### Navi \*



### Rhoda \*



### Diane Tech Switch \*

Empotrar / Recessed / Encastré / Recesso



### Diane Tech WAS \*

Empotrar / Recessed / Encastré / Recesso



### Silent I UGR \*



\* Bajo pedido  
On request  
Sur commande  
A pedido

AVISO / WARNING / AVERTISSEMENT / AVISO



Versión BLUETOOTH disponible bajo pedido.  
BLUETOOTH version available on request.  
Version BLUETOOTH disponible sur demande.  
Versão BLUETOOTH disponível a pedido.







Lámparas  
lamps  
lampes  
lâmpadas





GU5.3  
60°



GU10  
35°/60°



GU10  
100°



Barcode	Color	W <sub>r</sub>	⚡	φ	∠	K	Light Type	Dimensions	Notes
379540*	<b>G</b>	7W	12V ac/dc	622lm	60°	<b>5</b>	5.000K	GU5.3 Ø50 x 49mm	NO
379557*	<b>F</b>	7W	230V ac	578lm	60°	<b>3</b>	3.000K	GU10 Ø50 x 58mm	SI
379502*	<b>F</b>	7W	230V ac	622lm	60°	<b>5</b>	5.000K	GU10 Ø50 x 58mm	NO
400220*	<b>F</b>	7W	230V ac	608lm	35°	<b>4</b>	4.000K	GU10 Ø50 x 58mm	NO
379526*	<b>F</b>	7W	230V ac	622lm	35°	<b>5</b>	5.000K	GU10 Ø50 x 58mm	NO
379489*	<b>F</b>	7W	230V ac	622lm	100°	<b>5</b>	5.000K	GU10 Ø50 x 58mm	NO

\*Hasta fin de existencias/\* Until end of stock/\* Jusqu'à épuisement des stocks/\* Enquanto os estoques durarem

Hz	IP	Temp	Life	Life (L70B50>)
50-60Hz	IP20	-5°C~+35 °C	>80	(L70B50>)40.000h

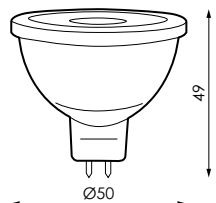

GU5.3

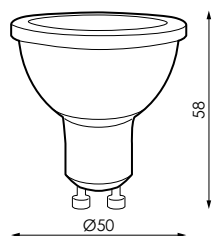

GU10

ACCESORIOS / ACCESSOIRES / ACCESSORIES / ACESSÓRIOS  
+ INFO PAG. 83



007931  
Portalámparas halógeno GU5.3



974851  
Portalámparas halógeno GU10

Ñ/ ICON EVO smart 60° regulable: Regulación TRIAC y tradicional de incandescencia. E/ ICON EVO smart 60° regulable: TRIAC regulation and traditional incandescent. F/ ICON EVO smart 60° regulable: Régulation TRIAC et incandescence traditionnelle. P/ ICON EVO smart 60° regulável: Regulação TRIAC e incandescente tradicional.

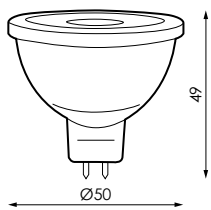

GU5.3

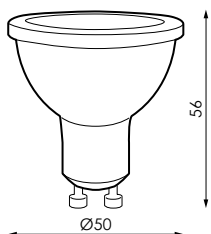

GU10

Barcode	Symbol	W <sub>t</sub>	V	Φ	Δ	K	Beam	Size	Beam	Beam
578820	<b>G</b>	6,5W	12V ac/dc	613lm	60°	<b>3</b>	3.000K	GU5.3	Ø50 x 49mm	NO
578837	<b>G</b>	6,5W	12V ac/dc	625lm	60°	<b>4</b>	4.000K	GU5.3	Ø50 x 49mm	NO
578844	<b>G</b>	6,5W	12V ac/dc	638lm	60°	<b>5</b>	5.000K	GU5.3	Ø50 x 49mm	NO
575072	<b>F</b>	6,5W	230V ac	613lm	60°	<b>3</b>	3.000K	GU10	Ø50 x 56mm	SI
575126	<b>F</b>	6,5W	230V ac	625lm	60°	<b>4</b>	4.000K	GU10	Ø50 x 56mm	SI
575089	<b>F</b>	6,5W	230V ac	638lm	60°	<b>5</b>	5.000K	GU10	Ø50 x 56mm	SI
575034	<b>F</b>	6,5W	230V ac	613lm	60°	<b>3</b>	3.000K	GU10	Ø50 x 56mm	NO
575102	<b>F</b>	6,5W	230V ac	625lm	60°	<b>4</b>	4.000K	GU10	Ø50 x 56mm	NO
575041	<b>F</b>	6,5W	230V ac	638lm	60°	<b>5</b>	5.000K	GU10	Ø50 x 56mm	NO
575058	<b>F</b>	6,5W	230V ac	627lm	35°	<b>3</b>	3.000K	GU10	Ø50 x 56mm	NO
575119	<b>F</b>	6,5W	230V ac	639lm	35°	<b>4</b>	4.000K	GU10	Ø50 x 56mm	NO
575065	<b>F</b>	6,5W	230V ac	652lm	35°	<b>5</b>	5.000K	GU10	Ø50 x 56mm	NO
575010	<b>F</b>	6,5W	230V ac	568lm	100°	<b>3</b>	3.000K	GU10	Ø50 x 56mm	NO
575096	<b>F</b>	6,5W	230V ac	584lm	100°	<b>4</b>	4.000K	GU10	Ø50 x 56mm	NO
575027	<b>F</b>	6,5W	230V ac	593lm	100°	<b>5</b>	5.000K	GU10	Ø50 x 56mm	NO

Hz	IP	Φ	Temp	Life	Beam
50-60Hz	IP20	>0,5	-5°C~+35°C	>80	(L70B50>)40.000h

ACCESORIOS / ACCESSOIRES / ACCESSORIES / ACESSÓRIOS

+ INFO PAG. 83



007931

Portalámparas halógeno GU5.3



974851

Portalámparas halógeno GU10

Ñ/ ICON basic regulable: Regulación TRIAC y tradicional de incandescencia. E/ ICON basic regulable: TRIAC regulation and traditional incandescent. F/ ICON basic regulable: Régulation TRIAC et incandescence traditionnelle. P/ ICON basic regulável: Regulação TRIAC e incandescente tradicional.



GU5.3



GU10



Barcode	Icon	W <sub>t</sub>	⚡	ϕ	ϕ <sub>t</sub>	K	Shield	↕	⌚
381826*	<b>G</b>	6W	12V ac/dc	>1	466lm	<b>3</b> 3.000K	GU5.3	∅50 x 47mm	NO
386302*	<b>G</b>	6W	12V ac/dc	>1	498lm	<b>4</b> 4.000K	GU5.3	∅50 x 47mm	NO
381833*	<b>G</b>	6W	12V ac/dc	>1	532lm	<b>5</b> 5.000K	GU5.3	∅50 x 47mm	NO
<b>N</b> 545457	<b>G</b>	6,5W	230V ac	>0,5	578lm	<b>3</b> 3.000K	GU10	∅50 x 58mm	SI
<b>N</b> 545464	<b>G</b>	6,5W	230V ac	>0,5	605lm	<b>4</b> 4.000K	GU10	∅50 x 58mm	SI
<b>N</b> 545471	<b>G</b>	6,5W	230V ac	>0,5	622lm	<b>5</b> 5.000K	GU10	∅50 x 58mm	SI
378727	<b>F</b>	7W	230V ac	>0,5	578lm	<b>3</b> 3.000K	GU10	∅50 x 58mm	NO
386326	<b>F</b>	7W	230V ac	>0,5	605lm	<b>4</b> 4.000K	GU10	∅50 x 58mm	NO
378734	<b>F</b>	7W	230V ac	>0,5	622lm	<b>5</b> 5.000K	GU10	∅50 x 58mm	NO

\*Hasta fin de existencias/\* Until end of stock/\* Jusqu'à épuisement des stocks/\* Enquanto os estoques durarem

Hz	⊙	⚡	∠	⌚	⏰
50-60Hz	IP20	-5°C~+35 °C	100°	>80	(L70B50>)25.000h

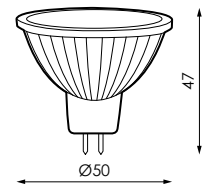

GU5.3

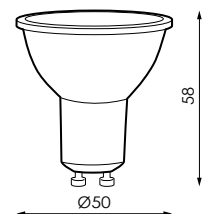

GU10

ACCESORIOS / ACCESSOIRES / ACCESSORIES / ACESSÓRIOS

+ INFO PAG. 83



007931

Portalámparas halógeno GU5.3



974851

Portalámparas halógeno GU10

# icon

## Mini basic

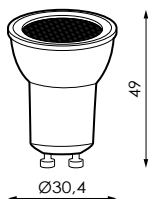

Barcode	Energy Class	W <sub>r</sub>	Φ	K	Dimensions
402071	<b>G</b>	2,5W	233lm	<b>3</b> 3.000K	Ø30,4 x 49mm
402088	<b>G</b>	2,5W	247lm	<b>4</b> 4.000K	Ø30,4 x 49mm

⚡	Hz	°	Φ	⚗	Δ	🌿	🛡️	🕒
230V ac	50-60Hz	IP20	>0,5	-5°C~+35°C	40°	>80	GU10	(L70B50>)15.000h

ACCESORIOS / ACCESSOIRES / ACCESSORIES / ACESSÓRIOS  
+ INFO PAG. 83



974851

Portalámparas halógeno GU10

# icon

## Par 20 smart

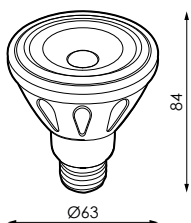

Barcode	Energy Class	W <sub>r</sub>	Φ	K	Dimensions
240970*	A+	8W	698lm	<b>5</b> 5.000K	Ø63 x 84mm

\*Hasta fin de existencias/\* Until end of stock/\* Jusqu'à épuisement des stocks/\* Enquanto os estoques durarem

⚡	Hz	°	Φ	⚗	Δ	🌿	🛡️	🕒
230V ac	50-60Hz	IP20	>0,57	-5°C~+35°C	45°	>80	E27	(L70B50>)30.000h



# icon

## Par 20 smart



Barcode	Beam Angle	W <sub>r</sub>	Current	Φ <sub>r</sub>	K	Dimensions
543224*	<b>E</b>	7W	55mA	602lm	<b>3</b> 3.000K	Ø63 x 82mm

\*Hasta fin de existencias/\* Until end of stock/\* Jusqu'à épuisement des stocks/\* Enquanto os estoques durarem

Voltage	Hz	IP	CF	Temp. Range	Beam Angle	Life Span	Base	Life Span
230V ac	50-60Hz	IP20	>0,55	-5°C~+35 °C	35°	>80	E27	(L70B50->)25.000h

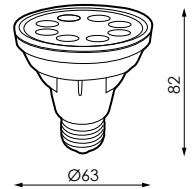

# icon

## Par 30 smart



Barcode	Beam Angle	W <sub>r</sub>	Current	Φ <sub>r</sub>	K	Dimensions
543248	<b>F</b>	10W	80mA	919lm	<b>3</b> 3.000K	Ø96 x 95mm
543255	<b>F</b>	10W	80mA	938lm	<b>5</b> 5.000K	Ø96 x 95mm

Voltage	Hz	IP	CF	Temp. Range	Beam Angle	Life Span	Base	Life Span
230V ac	50-60Hz	IP20	>0,55	-5°C~+35 °C	35°	>80	E27	(L70B50->)25.000h

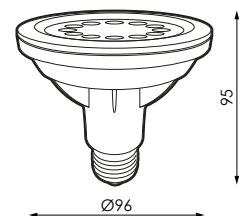

# icon

## Par 38 smart

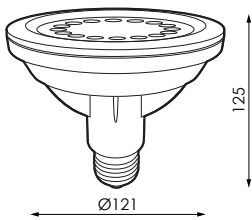

Barcode	Beam Angle	W <sub>r</sub>	Current	φ	K	Dimensions
543262		14W	120mA	1.254lm	<b>3</b> 3.000K	Ø121 x 125mm
543279		14W	120mA	1.306lm	<b>5</b> 5.000K	Ø121 x 125mm

⚡	Hz	°C	φ	⌚	∠	🌿	🛡️	⌚
230V ac	50-60Hz	IP20	>0,55	-5°C~+35 °C	35°	>80	E27	(L70B50>)25.000h

# icon

## Par 38 IP65 smart

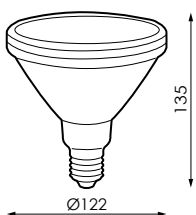

Barcode	Beam Angle	W <sub>r</sub>	φ	φ	K	🌿	Dimensions
155410		15W	>0,5	1.255lm	<b>3</b> 3.000K	>80	Ø122 x 135mm
155427		15W	>0,5	1.231lm	<b>5</b> 5.000K	>80	Ø122 x 135mm
155434	-	15W	-	-	<b>V</b> Verde	-	Ø122 x 135mm

⚡	Hz	°C	⌚	∠	🛡️	⌚
230V ac	50-60Hz	IP65	-5°C~+35 °C	30°	E27	(L70B50>)40.000h

# icon

## Par 56 smart

Ñ/ Sin mando a distancia.  
 RGB con efecto memoria. E/  
 Without remote control. RGB  
 with memory effect. F/ Sans  
 télécommande. RVB avec effet  
 de mémoire. P/ Sem controle  
 remoto. RGB com efeito de  
 memória.



Barcode	Control	W <sub>r</sub>	Current	Φ <sub>r</sub>	Color	Temp	Beam
495035	F	20W	1.650mA	1.709lm	3	3.000K	Ø177 x 105mm
534031	G	20W	1.650mA	1.793lm	5	5.000K	Ø177 x 105mm
534048	-	18W	1.500mA	-	R G B	RGB SINCRO	Ø177 x 105mm
534055	-	18W	1.500mA	-	R G B	RGB ON/OFF	Ø177 x 105mm

Voltage	Frequency	Protection	Beam Angle	Life	Base	Life
12V ac	50-60Hz	IP68	100°	>70	G53	(L70B50>)30.000h

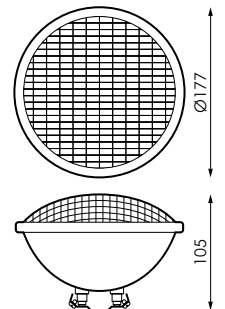

### ACCESORIOS / ACCESSOIRES / ACCESSORIES / ACESSÓRIOS

+ INFO PAG. 83



164122\*  
 Sincronizador wireless (Válido para 534055)



442374  
 Controlador RGB con mando (Válido para 534048)



534062  
 Transformador magnético máx. 300W



534352  
 Transformador magnético máx. 500W

\*Hasta fin de existencias/\* Until end of stock/\* Jusqu'à épuisement des stocks/\* Enquanto os estoques durarem



Ñ/ ICON QR111 smart regulable: Regulación TRIAC y tradicional de incandescencia. E/ ICON QR111 smart regulable: TRIAC regulation and traditional incandescent. F/ ICON QR111 smart regulable: Régulation TRIAC et incandescence traditionnelle. P/ ICON QR111 smart regulável: Regulação TRIAC e incandescente tradicional.

# icon

## Qr 111 smart

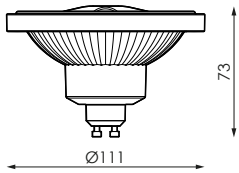

Barcode	Icon	W <sub>r</sub>	φ	K	Dimensions	Beam Angle
576581	F	12W	902lm	3	3.000K Ø111 x 73mm	SI
576598	F	12W	987lm	5	5.000K Ø111 x 73mm	SI
576604	F	12W	902lm	3	3.000K Ø111 x 73mm	NO
576611	F	12W	987lm	5	5.000K Ø111 x 73mm	NO

Voltage	Frequency	Protection	Beam Angle	Temp. Range	Beam Spread	Color Temp.	Base	Life
230V ac	50-60Hz	IP20	>0,5	-5°C~+35 °C	45°	>80	GU10	(L70B50>)40.000h



[GRÁFICOS: Unidades en mm/GRÁFICOS: Units in mm/GRÁFICOS: Unités en mm/GRÁFICOS: Unidades em mm]

# icon

## Qr 111 smart

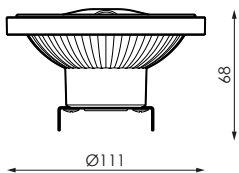

Barcode	Icon	W <sub>r</sub>	φ	K	Dimensions	Beam Angle
576628	F	12W	902lm	3	3.000K Ø111 x 68mm	NO
576635	F	12W	987lm	5	5.000K Ø111 x 68mm	NO

Voltage	Frequency	Protection	Beam Angle	Temp. Range	Beam Spread	Color Temp.	Base	Life
12V ac	50-60Hz	IP20	>0,5	-5°C~+35 °C	45°	>80	G53	(L70B50>)40.000h

# icon

## Qr 111 smart



GU10



G53

Ñ/ ICON QR111 smart regulable: Regulación TRIAC y tradicional de incandescencia. E/ ICON QR111 smart regulable: TRIAC regulation and traditional incandescent. F/ ICON QR111 smart regulable: Régulation TRIAC et incandescence traditionnelle. P/ ICON QR111 smart regulável: Regulação TRIAC e incandescente tradicional.

Barcode	Energy Class	Power (W <sub>r</sub> )	Voltage	Lumen (lm)	Beam Angle (°)	Life (h)	Color Temp (K)	Base	Dimensions	Dimming
497671*	A+	12W	230V ac	1.013lm	36°	5	5.000K	GU10	Ø111 x 76mm	SI
497640*	<b>G</b>	12W	12V ac	792lm	24°	3	3.000K	G53	Ø111 x 67mm	NO
497657*	<b>G</b>	12W	12V ac	808lm	24°	5	5.000K	G53	Ø111 x 67mm	NO

\*Hasta fin de existencias/\* Until end of stock/\* Jusqu'à épuisement des stocks/\* Enquanto os estoques durarem

Hz	IP	CR	Temp Range	Life (h)	Warranty
50-60Hz	IP20	>0,9	-5°C~+35 °C	>80	(L70B50>)30.000h

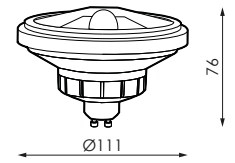

GU10

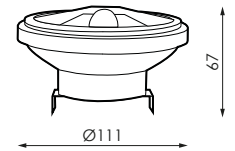

G53

# icon

## Qr 111 basic



Barcode	Energy Class	Power (W <sub>r</sub> )	Lumen (lm)	Life (h)	Color Temp (K)	Dimensions
562744	<b>F</b>	12W	864lm	3	3.000K	Ø111 x 62mm
562751	<b>F</b>	12W	915lm	4	4.000K	Ø111 x 62mm

Voltage	Hz	IP	Temp Range	Beam Angle	Life (h)	Base	Warranty
12V ac	50-60Hz	IP20	-5°C~+35 °C	30°	>80	G53	(L70B50>)30.000h

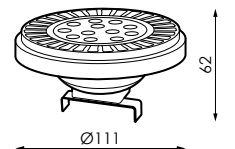

G53





# esSENSE

## Linestra smart

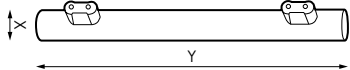
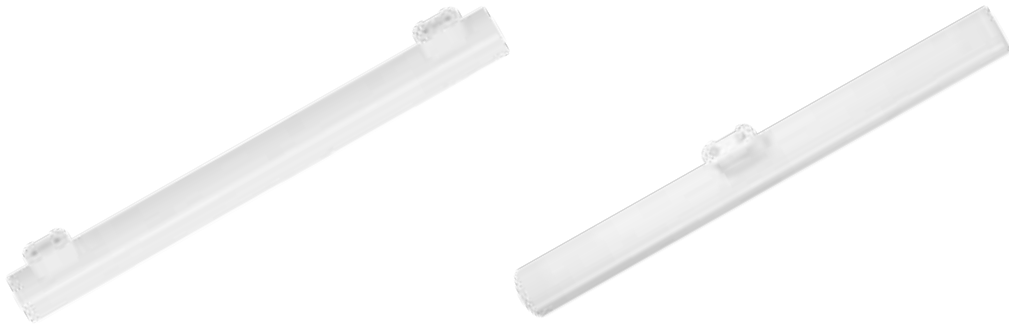

S14s

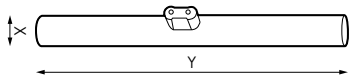

S14d

		$W_T$	$\phi$	$K$		$\leftrightarrow$
515375	A++	7,5W	867lm	<b>3</b>	3.000K	S14s 30 x 500mm
499422	A+	14W	1.614lm	<b>3</b>	3.000K	S14s 30 x 1.000mm
576642	<b>E</b>	5W	546lm	<b>3</b>	3.000K	S14d 30 x 300mm
576659	<b>E</b>	7,5W	867lm	<b>3</b>	3.000K	S14d 30 x 500mm

	Hz			$\Delta$		
230V ac	50-60Hz	IP20	-5°C~+35 °C	150°	>80	(L70B50>)25.000h

Hasta 5 años de garantía  
Up to 5 years of warranty  
Jusqu'à 5 ans de garantie  
Alé 5 ans de garantia



# esSENSE

## Linestra nova S14d

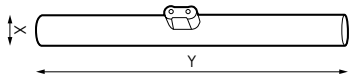

		$W_T$	$\phi$	$K$	$\leftrightarrow$
412001*	A++	5W	546lm	<b>3</b>	3.000K 30 x 300mm

\*Hasta fin de existencias/\* Until end of stock/\* Jusqu'à épuisement des stocks/\* Enquanto os estoques durarem

	Hz			$\Delta$		
230V ac	50-60Hz	IP20	-5°C~+35 °C	150°	>80	S14d (L70B50>)25.000h

[GRÁFICOS: Unidades en mm/GRÁFICOS: Units in mm/GRAPHIQUES: Unités en mm/GRÁFICOS: Unidades em mm]

# esSENSE

Sofito smart



Barcode	Beam Spread	Power (W <sub>r</sub> )	Lumen (lm)	Beam Spread	Color Temp (K)	Dimensions
402095	F	9W	805lm	3	3.000K	Ø38 x 315mm
402101	F	9W	857lm	4	4.000K	Ø38 x 315mm

  

Voltage	Frequency	Protection	Beam Angle	Temp Range	Beam Spread	Material	Life Span
230V ac	50-60Hz	IP20	>0,5	-5°C~+35 °C	200°	>80	S19 (L70B50>)25.000h

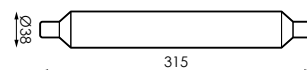

# esSENSE

## Flame smart

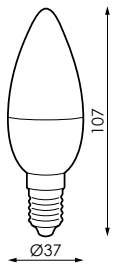

		$W_r$	$\phi$	K	
392761*	A++	5W	524lm	<b>3</b> 3.000K	$\phi 37 \times 107\text{mm}$

\*Hasta fin de existencias/\* Until end of stock/\* Jusqu'à épuisement des stocks/\* Enquanto os estoques durarem

	Hz		$\phi$					
230V ac	50-60Hz	IP20	>0,5	-5°C~+35 °C	180°	>80	E14	(L70B50>)25.000h

**N**  
NEW

# esSENSE

## Flame basic

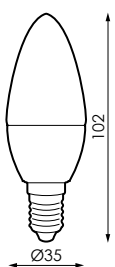

		$W_r$	$\phi$	K	
524513	<b>F</b>	5W	489lm	<b>3</b> 3.000K	$\phi 35 \times 102\text{mm}$
524520	<b>F</b>	5W	501lm	<b>4</b> 4.000K	$\phi 35 \times 102\text{mm}$
524544	<b>F</b>	5W	506lm	<b>5</b> 5.000K	$\phi 35 \times 102\text{mm}$

	Hz		$\phi$					
230V ac	50-60Hz	IP20	>0,5	-5°C~+35 °C	280°	>80	E14	(L70B50>)15.000h

# esSENSE

## Ball basic

**N**  
NEW



Barcode	Class	W <sub>r</sub>	Φ	K	Base	Dimensions
524711	F	5W	493lm	3	3.000K	E14 Ø45 x 78mm
524728	F	5W	501lm	4	4.000K	E14 Ø45 x 78mm
524735	F	5W	511lm	5	5.000K	E14 Ø45 x 78mm
524551	F	5W	493lm	3	3.000K	E27 Ø45 x 74mm
524568	F	5W	501lm	4	4.000K	E27 Ø45 x 74mm
524575	F	5W	511lm	5	5.000K	E27 Ø45 x 74mm

Voltage	Frequency	Protection	Dimming	Temp. Range	Beam Angle	Life Span	Warranty
230V ac	50-60Hz	IP20	>0,5	-5°C~+35 °C	240°	>80	(L70B50>)15.000h

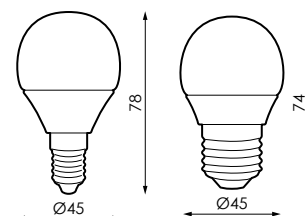

E14

E27



# esSENSE

## Standard smart



16W

19W

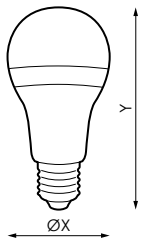

		$W_T$	$\phi$	K	
502658		16W	1.311lm	<b>3</b>	3.000K $\phi 69 \times 144\text{mm}$
497800		16W	1.634lm	<b>5</b>	5.000K $\phi 69 \times 144\text{mm}$
497817		19W	1.985lm	<b>3</b>	3.000K $\phi 95 \times 174\text{mm}$
497824		19W	2.031lm	<b>5</b>	5.000K $\phi 95 \times 174\text{mm}$

	Hz		$\phi$					
230V ac	50-60Hz	IP20	>0,5	-5°C~+35 °C	210°	>80	E27	(L70B50>)40.000h

# esSENSE

## Standard basic 12/24V

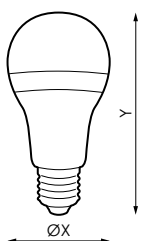

		$W_T$	$\phi$	K	
402156		8W	764lm	<b>3</b>	3.000K $\phi 60 \times 110\text{mm}$
402163		8W	805lm	<b>4</b>	4.000K $\phi 60 \times 110\text{mm}$

	Hz		$\phi$					
12Vac/dc -24V dc	50-60Hz	IP20	>0,5	-5°C~+35 °C	210°	>80	E27	(L70B50>)25.000h



# esSENSE

## Standard basic

**N**  
NEW



5/8,5W

10,5W



		$W_T$	$\phi$	K	$\leftrightarrow$
524582		5W	456lm		3.000K $\phi 60 \times 102\text{mm}$
524599		5W	472lm		4.000K $\phi 60 \times 102\text{mm}$
524605		5W	483lm		5.000K $\phi 60 \times 102\text{mm}$
524612		8,5W	841lm		3.000K $\phi 60 \times 102\text{mm}$
524629		8,5W	876lm		4.000K $\phi 60 \times 102\text{mm}$
524636		8,5W	903lm		5.000K $\phi 60 \times 102\text{mm}$
524643		10,5W	1.018lm		3.000K $\phi 60 \times 120\text{mm}$
524650		10,5W	1.039lm		4.000K $\phi 60 \times 120\text{mm}$
524667		10,5W	1.067lm		5.000K $\phi 60 \times 120\text{mm}$

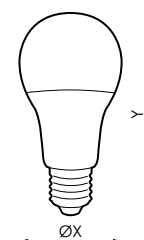

	Hz		$\phi$		$\Delta$			
230V ac	50-60Hz	IP20	>0,5	-5°C~+35 °C	220°	>80	E27	(L70B50>)15.000h





9,5W

13,5W

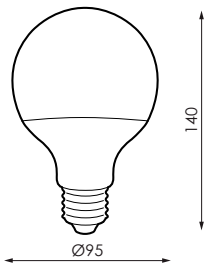

9,5W

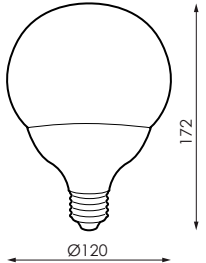

13,5W



		W <sub>r</sub>	φ	Δ	K		
562782		9,5W	1.055lm	200°	<b>3</b>	3.000K	Ø95 x 140mm
562799		9,5W	1.055lm	200°	<b>4</b>	4.000K	Ø95 x 140mm
562805		13,5W	1.521lm	220°	<b>3</b>	3.000K	Ø120 x 172mm
562812		13,5W	1.521lm	220°	<b>4</b>	4.000K	Ø120 x 172mm

	Hz		φ				
230V ac	50-60Hz	IP20	>0,5	-5°C~+35 °C	>80	E27	(L70B50>)25.000h

[GRÁFICOS: Unidades en mm/GRÁFICOS: Units in mm/GRAPHICS: Units in mm/GRÁFICOS: Unidades em mm]



# esSENSE

## Circle smart



Barcode	Color	W <sub>r</sub>	Φ	K	Dimensions
548786*		20W	1.806lm		3.000K Ø190,5 x 109mm
548793*		20W	1.883lm		4.000K Ø190,5 x 109mm

\*Hasta fin de existencias/\* Until end of stock/\* Jusqu'à épuisement des stocks/\* Enquanto os estoques durarem

⚡	Hz	°	⌚	∠	🌿	🏠	🕒
230V ac	50-60Hz	IP20	-5°C~+35 °C	120°	>80	E27	(L70B50>)25.000h

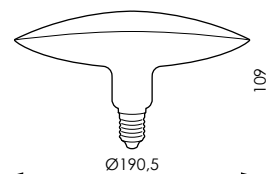

# fiSENSE Gold

## Drop smart

Filamento Led  
Led Filament  
Filament Led  
Filamento Led



4,5W

7,5W



Barcode	Color	W <sub>r</sub>	Φ	K	Dimensions
402170		4,5W	458lm		2.500K Ø58 x 134mm
402187		7,5W	760lm		2.500K Ø64 x 141mm

⚡	Hz	°	Φ	⌚	∠	🌿	🏠	🕒
230V ac	50-60Hz	IP20	>0,7	-5°C~+35 °C	280°	>80	E27	(L70B50>)15.000h

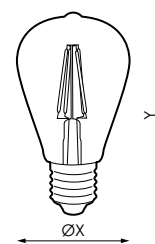

Ñ/ fiSENSE GOLD: Regulación TRIAC y tradicional de incandescencia. Instalación en posición vertical. E/ fiSENSE GOLD: TRIAC regulation and traditional incandescent. Installation in vertical position. F/ fiSENSE GOLD: régulation TRIAC et incandescence traditionnelle. Installation en position verticale. P/ fiSENSE GOLD: Regulação TRIAC e incandescente tradicional. Instalação na posição vertical.

Ñ/ fiSENSE GOLD: Regulación TRIAC y tradicional de incandescencia. Instalación en posición vertical. E/ fiSENSE GOLD: TRIAC regulation and traditional incandescent. Installation in vertical position. F/ fiSENSE GOLD: régulation TRIAC et incandescence traditionnelle. Installation en position verticale. P/ fiSENSE GOLD: Regulação TRIAC e incandescente tradicional. Instalação na posição vertical.

# fiSENSE Gold

## Globe smart

Filamento Led  
Led Filament  
Filament Led  
Filamento Led



4W

7,5W

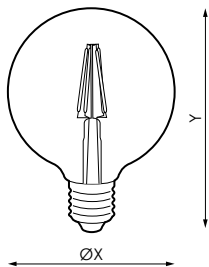

		W <sub>r</sub>	φ	K	
402194	<b>F</b>	4W	463lm	<b>2,5</b>	2.500K Ø95 x 143mm
402200	<b>F</b>	7,5W	736lm	<b>2,5</b>	2.500K Ø125 x 178mm

	Hz		φ						
230V ac	50-60Hz	IP20	>0,7	-5°C~+35 °C	280°	>80	E27	(L70B50>)15.000h	SI

Ñ/ Instalación en posición vertical. E/ Installation in vertical position. F/ Installation en position verticale. P/ Instalação na posição vertical.

# fiSENSE

## Flame smart

Filamento Led  
Led Filament  
Filament Led  
Filamento Led

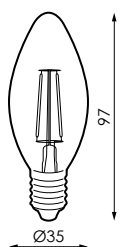

		W <sub>r</sub>	φ	K	
237345*	A++	2,5W	267lm	<b>2,7</b>	2.700K Ø35 x 97mm
237352*	<b>F</b>	4W	470lm	<b>2,7</b>	2.700K Ø35 x 97mm

\*Hasta fin de existencias/\* Until end of stock/\* Jusqu'à épuisement des stocks/\* Enquanto os estoques durarem

	Hz		φ					
230V ac	50-60Hz	IP20	>0,4	-5°C~+35 °C	330°	>80	E14	(L70B50>)20.000h

# fiSENSE

## Flame Fantasy smart



Filamento Led  
Led Filament  
Filament Led  
Filamento Led



		$W_T$	$\phi_T$	<b>K</b>	
237376*	A++	4W	403lm	<b>27</b> 2.700K	Ø35 x 123mm

\*Hasta fin de existencias/\* Until end of stock/\* Jusqu'à épuisement des stocks/\* Enquanto os estoques durarem

	Hz		$\phi$		$\Delta$		
230V ac	50-60Hz	IP20	>0,4	-5°C~+35 °C	360°	>80	E14 (L70B50>)20.000h

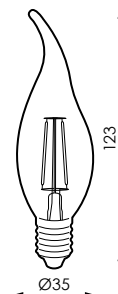

Ñ/ Instalación en posición vertical. E/ Installation in vertical position. F/ Installation en position verticale. P/ Instalação na posição vertical.

# fiSENSE

## Ball smart



Filamento Led  
Led Filament  
Filament Led  
Filamento Led



		$W_T$	$\phi_T$	<b>K</b>		
237390*	<b>E</b>	4W	403lm	<b>27</b> 2.700K	E27	Ø45 x 80mm

	Hz		$\phi$		$\Delta$		
230V ac	50-60Hz	IP20	>0,5	-5°C~+35 °C	360°	>80	(L70B50>)20.000h

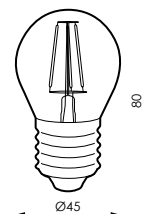

Ñ/ Instalación en posición vertical. E/ Installation in vertical position. F/ Installation en position verticale. P/ Instalação na posição vertical.



Ñ/ Instalación en posición vertical. E/ Installation in vertical position. F/ Installation en position verticale. P/ Instalação na posição vertical.

# fiSENSE

## Standard smart

Filamento Led  
Led Filament  
Filament Led  
Filamento Led

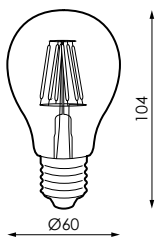

Barcode	Shape	W <sub>r</sub>	Φ	K	Dimensions
237321*	E	7W	739lm	27	2700K Ø60 x 108mm
237338*	E	7W	841lm	4	4000K Ø60 x 108mm

\*Hasta fin de existencias/\* Until end of stock/\* Jusqu'à épuisement des stocks/\* Enquanto os estoques durarem

⚡	Hz	IP	Φ	⌚	⚙️	🌿	🏠	🕒
230V ac	50-60Hz	IP20	>0,5	-5°C~+35 °C	330°	>80	E27	(L70B50>)20.000h

Ñ/ Instalación en posición vertical. E/ Installation in vertical position. F/ Installation en position verticale. P/ Instalação na posição vertical.

# fiSENSE

## Globe smart

Filamento Led  
Led Filament  
Filament Led  
Filamento Led

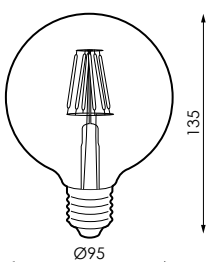

Barcode	Shape	W <sub>r</sub>	Φ	K	Dimensions
237406*	E	7W	768lm	27	2700K Ø95 x 135mm

⚡	Hz	IP	Φ	⌚	⚙️	🌿	🏠	🕒
230V ac	50-60Hz	IP20	>0,5	-5°C~+35 °C	330°	>80	E27	(L70B50>)20.000h

# True colors

## Aluminio

**esSense**  
 CIRCLE

**fiSense**  
 GOLD

**fiSense**

**Recomendación**  
 Recommendation  
 Recommendation  
 Recomendação



Barcode	W <sub>r</sub>	Material	Color	Dimensions
545884*	Máx. 60W	Ni	Níquel	Ø98 x 1000mm
545891*	Máx. 60W	Br	Bronce	Ø98 x 1000mm

\*Hasta fin de existencias/\* Until end of stock/\* Jusqu'à épuisement des stocks/\* Enquanto os estoques durarem

Voltage	Frequency	Mounting	Protection	Socket	Material
230V ac	50-60Hz	CII	IP20	E27	AL

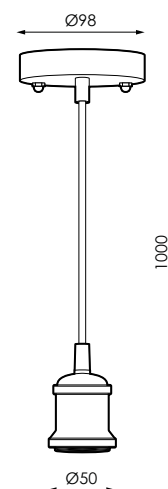

### AVISO / WARNING / AVERTISSEMENT / AVISO

Ñ/ Máximo peso soportado por el portalámparas es de 1kg.

E/ Maximun weight supported by the lampholder is 1kg.

F/ Le poids maximal supporté par la douille est de 1kg.

P/O peso máximo que suporta este artigo é de 1kg.

# True colors

PET

Recomendación	esSense CIRCLE	fiSense GOLD	fiSense
Recommendation			
Recomendação			

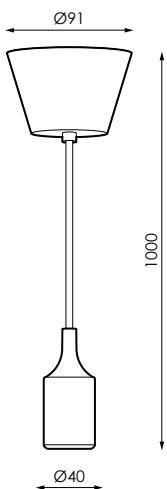

Barcode	W <sub>r</sub>	Color	Dimensions
545907*	Máx. 60W	Blanco	Ø91 x 1000mm
545914*	Máx. 60W	Negro	Ø91 x 1000mm

\*Hasta fin de existencias/\* Until end of stock/\* Jusqu'à épuisement des stocks/\* Enquanto os estoques durarem

⚡	Hz	□	⊙	⊓	📄
230V ac	50-60Hz	CII	IP20	E27	PET

## AVISO / WARNING / AVERTISSEMENT / AVISO

Ñ/ Máximo peso soportado por el portalámparas es de 1kg.

E/ Maximun weight supported by the lampholder is 1kg.

F/ Le poids maximal supporté par la douille est de 1kg.

P/O peso máximo que suporta este artigo é de 1kg.

# ecPOWER

## Compact smart

**N**  
NEW



28W

37,5W



Barcode	Base	W <sub>r</sub>	Φ	K	Height	
521321	E	28W	3.410lm	3	3.000K	∅100 x 160mm
521338	E	28W	3.560lm	4	4.000K	∅100 x 160mm
521345	E	28W	3.715lm	6,5	6.500K	∅100 x 160mm
521352	E	37,5W	4.511lm	3	3.000K	∅118 x 186mm
521369	E	37,5W	4.620lm	4	4.000K	∅118 x 186mm
521376	E	37,5W	4.732lm	6,5	6.500K	∅118 x 186mm

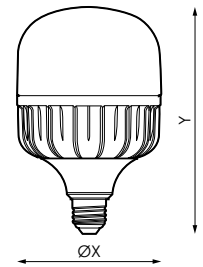

⚡	Hz	IP	Φ	⌚	⌚	🌿	🏠	🕒
100-240V ac	50-60Hz	IP20	>0,9	-10°C~+35 °C	180°	>80	E27	(L70B50>)25.000h

### AVISO / WARNING / AVERTISSEMENT / AVISO

Ñ/ La temperatura ambiente de trabajo no puede superar en ningún caso los 50°C, por tanto, no es recomendable la utilización de estas lámparas en luminarias cerradas donde se puedan superar estas temperaturas, ya que se puede reducir significativamente la vida útil del producto. La falta de ventilación o volumen de aire suficiente eleva la temperatura por encima de los límites de uso del producto.

E/ The working ambient temperature can not exceed 50°C in any case, therefore, it is not advisable to use these bulbs in closed luminaires where these temperatures can be overcome, since the useful life of the product can be significantly reduced. Lack of ventilation or sufficient air volume raises the temperature above the limits of product use.

F/ La température ambiante de travail ne doit en aucun cas dépasser 50°C. Par conséquent, il est déconseillé d'utiliser ces ampoules dans des luminaires fermés où ces températures peuvent être surmontées, car la durée de vie du produit peut être considérablement réduite. Le manque de ventilation ou un volume d'air suffisant élève la température au-dessus des limites d'utilisation du produit.

P/ A temperatura ambiente de trabalho não pode exceder 50°C em qualquer caso, portanto, não é aconselhável utilizar estas lâmpadas em luminárias fechadas onde estas temperaturas possam ser superadas, uma vez que a vida útil do produto pode ser significativamente reduzida. A falta de ventilação ou volume de ar suficiente aumenta a temperatura acima dos limites de uso do produto.

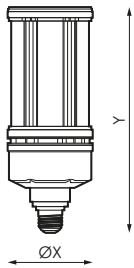

Barcode	Base	W <sub>t</sub>	Φ	K	Shield	Dimensions
521383	E	27W	3.333lm	3	3.000K	E27 Ø70 x 206mm
521390	E	27W	3.480lm	4	4.000K	E27 Ø70 x 206mm
521406	E	27W	3.607lm	6.5	6.500K	E27 Ø70 x 206mm
521413	E	36W	4.492lm	3	3.000K	E40 Ø90 x 235mm
521420	E	36W	4.527lm	4	4.000K	E40 Ø90 x 235mm
521437	E	36W	4.683lm	6.5	6.500K	E40 Ø90 x 235mm
521444	E	45W	5.852lm	3	3.000K	E40 Ø90 x 251mm
521451	E	45W	5.948lm	4	4.000K	E40 Ø90 x 251mm
521468	E	45W	6.089lm	6.5	6.500K	E40 Ø90 x 251mm
521475	E	54W	6.812lm	3	3.000K	E40 Ø90 x 266mm
521482	E	54W	6.975lm	4	4.000K	E40 Ø90 x 266mm
521499	E	54W	7.021lm	6.5	6.500K	E40 Ø90 x 266mm

⚡	Hz	°	Φ	⌚	Λ	🌿	🕒
220-240V ac	50-60Hz	IP64	>0,9	-10°C~+35°C	330°	>80	(L70B50>)50.000h

### AVISO / WARNING / AVERTISSEMENT / AVISO

Ñ/ La temperatura ambiente de trabajo no puede superar en ningún caso los 50°C, por tanto, no es recomendable la utilización de estas lámparas en luminarias cerradas donde se puedan superar estas temperaturas, ya que se puede reducir significativamente la vida útil del producto. La falta de ventilación o volumen de aire suficiente eleva la temperatura por encima de los límites de uso del producto.

E/ The working ambient temperature can not exceed 50°C in any case, therefore, it is not advisable to use these bulbs in closed luminaires where these temperatures can be overcome, since the useful life of the product can be significantly reduced. Lack of ventilation or sufficient air volume raises the temperature above the limits of product use.

F/ La température ambiante de travail ne doit en aucun cas dépasser 50°C. Par conséquent, il est déconseillé d'utiliser ces ampoules dans des luminaires fermés où ces températures peuvent être surmontées, car la durée de vie du produit peut être considérablement réduite. Le manque de ventilation ou un volume d'air suffisant élève la température au-dessus des limites d'utilisation du produit.

P/ A temperatura ambiente de trabalho não pode exceder 50°C em qualquer caso, portanto, não é aconselhável utilizar estas lâmpadas em luminárias fechadas onde estas temperaturas possam ser superadas, uma vez que a vida útil do produto pode ser significativamente reduzida. A falta de ventilação ou volume de ar suficiente aumenta a temperatura acima dos limites de uso do produto.



# ecPOWER

## smart

Ñ/ En modelos 55W no se recomienda el montaje en posición horizontal. E/ For the 55W models, horizontal mounting is not recommended. F/ Pour les modèles 55W, le montage horizontal n'est pas recommandé. P/ Para os modelos de 55W, a montagem horizontal não é recomendada.



Barcode	Color	W <sub>r</sub>	φ	K	Color Temp	Base	Dimensions
475747*	F	55W	5.345lm	3	3.000K	E27	Ø106 x 303mm
385602*	F	55W	6.144lm	4	4.000K	E27	Ø106 x 303mm
385619*	E	55W	6.334lm	6.5	6.500K	E27	Ø106 x 303mm
475754*	F	55W	5.345lm	3	3.000K	E40	Ø106 x 317mm

\*Hasta fin de existencias/\* Until end of stock/\* Jusqu'à épuisement des stocks/\* Enquanto os estoques durarem

Voltage	Hz	IP	Warning	Beam Angle	Life	Dimming
100-240V ac	50-60Hz	IP20	⚠	290°	>80	(L70B50)>25.000h

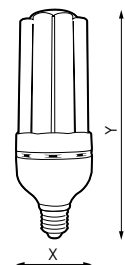

### AVISO / WARNING / AVERTISSEMENT / AVISO

Ñ/ La temperatura ambiente de trabajo no puede superar en ningún caso los 50°C, por tanto, no es recomendable la utilización de estas lámparas en luminarias cerradas donde se puedan superar estas temperaturas, ya que se puede reducir significativamente la vida útil del producto. La falta de ventilación o volumen de aire suficiente eleva la temperatura por encima de los límites de uso del producto.

E/ The working ambient temperature can not exceed 50°C in any case, therefore, it is not advisable to use these bulbs in closed luminaires where these temperatures can be overcome, since the useful life of the product can be significantly reduced. Lack of ventilation or sufficient air volume raises the temperature above the limits of product use.

F/ La température ambiante de travail ne doit en aucun cas dépasser 50°C. Par conséquent, il est déconseillé d'utiliser ces ampoules dans des luminaires fermés où ces températures peuvent être surmontées, car la durée de vie du produit peut être considérablement réduite. Le manque de ventilation ou un volume d'air suffisant élève la température au-dessus des limites d'utilisation du produit.

P/ A temperatura ambiente de trabalho não pode exceder 50°C em qualquer caso, portanto, não é aconselhável utilizar estas lâmpadas em luminárias fechadas onde estas temperaturas possam ser superadas, uma vez que a vida útil do produto pode ser significativamente reduzida. A falta de ventilação ou volume de ar suficiente aumenta a temperatura acima dos limites de uso do produto.

# Tubular







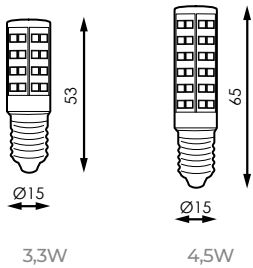

## Mini smart



3,3W

4,5W



		W <sub>r</sub>	φ	K			
482684	 <b>F</b>	3,3W	507lm	<b>3</b> 3.000K	Ø15 x 53mm		
482691	 <b>F</b>	4,5W	421lm	<b>3</b> 3.000K	Ø15 x 65mm		
	Hz						
230V ac	50-60Hz	IP20	-5°C~+35 °C	360°	>80	E14	(L70B50>)25.000h



# esSENSE

## Tubular smart



7W

9W

12W



		$W_T$	$\phi$	$\Phi$	K	
482103		7W	689lm	>0,5		3.000K $\varnothing 38 \times 109\text{mm}$
481335		7W	728lm	>0,5		4.000K $\varnothing 38 \times 109\text{mm}$
481342		7W	767lm	>0,5		5.000K $\varnothing 38 \times 109\text{mm}$
482110		9W	924lm	>0,5		3.000K $\varnothing 38 \times 109\text{mm}$
481359		9W	893lm	>0,5		4.000K $\varnothing 38 \times 109\text{mm}$
481366		9W	907lm	>0,5		5.000K $\varnothing 38 \times 109\text{mm}$
482127		12W	1.157lm	>0,5		3.000K $\varnothing 38 \times 155\text{mm}$
481380		12W	1.311lm	>0,5		4.000K $\varnothing 38 \times 155\text{mm}$
481397		12W	1.373lm	>0,5		5.000K $\varnothing 38 \times 155\text{mm}$

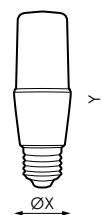

	Hz			$\Delta$			
230V ac	50-60Hz	IP20	-5°C~+35 °C	270°	>80	E27	(L70B50>)40.000h



# esSENSE

## Tubular smart



15W

20W

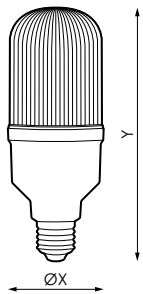

		$W_r$	$\phi_r$	$\phi$	$K$	
482134		15W	1.438lm	>0,5		3.000K $\phi 65 \times 150\text{mm}$
481403		15W	1.502lm	>0,5		4.000K $\phi 65 \times 150\text{mm}$
481410		15W	1.563lm	>0,5		5.000K $\phi 65 \times 150\text{mm}$
482141		20W	2.011lm	>0,9		3.000K $\phi 65 \times 170\text{mm}$
481427		20W	2.063lm	>0,9		4.000K $\phi 65 \times 170\text{mm}$
481434		20W	2.108lm	>0,5		5.000K $\phi 65 \times 170\text{mm}$

	$\text{Hz}$			$\text{A}$			
230V ac	50-60Hz	IP20	-5°C~+35 °C	270°	>80	E27	(L70B50>)40.000h



# esSENSE

## R50 smart



Anti Deslumbramiento  
Anti Glare  
Anti-Éblouissement  
Antiencandeamiento



Barcode	Beam Angle	W <sub>r</sub>	φ	K	Dimensions
977906	<b>G</b>	4,5W	407lm	<b>3</b> 3.000K	Ø50 x 86mm
977913	<b>F</b>	4,5W	454lm	<b>5</b> 5.000K	Ø50 x 86mm

⚡	Hz	IP	φ	Temp	Beam	Life	Base	Life
230V ac	50-60Hz	IP20	>0,5	-5°C~+35 °C	110°	>80	E14	(L70B50>)40.000h

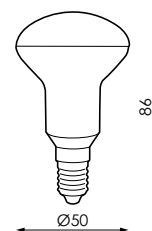

# esSENSE

## R63 smart



Anti Deslumbramiento  
Anti Glare  
Anti-Éblouissement  
Antiencandeamiento



Barcode	Beam Angle	W <sub>r</sub>	φ	K	Dimensions
168472	<b>F</b>	8W	750lm	<b>3</b> 3.000K	Ø63 x 105mm
235761	<b>F</b>	8W	789lm	<b>5</b> 5.000K	Ø63 x 105mm

⚡	Hz	IP	φ	Temp	Beam	Life	Base	Life
230V ac	50-60Hz	IP20	>0,5	-5°C~+35 °C	125°	>80	E27	(L70B50>)40.000h



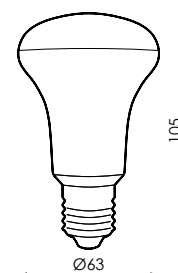

# esSENSE

## R80 smart

Anti Deslumbramiento  
Anti Glare  
Anti-Éblouissement  
Antiencandeamento

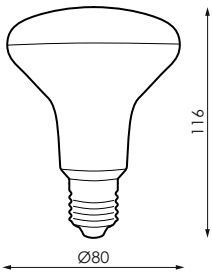

Barcode	Beam Angle	W <sub>r</sub>	Φ <sub>r</sub>	K	Dimensions
239950		9W	832lm	<b>3</b> 3.000K	Ø80 x 116mm
238106		9W	911lm	<b>5</b> 5.000K	Ø80 x 116mm

  

⚡	Hz	IP	Φ	Temp	Beam	Life	Base	Life
230V ac	50-60Hz	IP20	>0,5	-5°C~+35 °C	120°	>80	E27	(L70B50>)30.000h

# esSENSE

## R90 smart

Anti Deslumbramiento  
Anti Glare  
Anti-Éblouissement  
Antiencandeamento

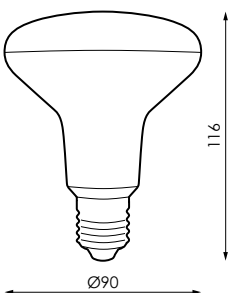

Barcode	Beam Angle	W <sub>r</sub>	Φ <sub>r</sub>	Beam	K	Dimensions
476706		8W	681lm	115°	<b>3</b> 3.000K	Ø90 x 116mm
476713		8W	752lm	115°	<b>5</b> 5.000K	Ø90 x 116mm
476720		12W	1.055lm	120°	<b>3</b> 3.000K	Ø90 x 116mm
476737		12W	1.145lm	120°	<b>5</b> 5.000K	Ø90 x 116mm

⚡	Hz	IP	Φ	Temp	Beam	Life	Base	Life
230V ac	50-60Hz	IP20	>0,5	-5°C~+35 °C	>80	E27	(L70B50>)40.000h	

# SPOTCAB

smart

Ñ/ Uso recomendado con portalámparas y marco Microlynx.  
 E/ Suitable for lamp holder and Microlynx frame. F/ Convient pour support de lampe et cadre Microlynx. P/ Apropriado para o suporte da lâmpada e quadro Microlynx.



Barcode	Color	W <sub>r</sub>	φ	K	Dimensions
977944	<b>G</b>	7W	628lm	<b>3</b> 3.000K	Ø75 x 28mm
977951	<b>F</b>	7W	643lm	<b>4</b> 4.000K	Ø75 x 28mm

  

⚡	Hz	IP	φ	🌡️	∠	🌿	🏠	🕒
230V ac	50-60Hz	IP20	>0,5	-5°C~+35 °C	110°	>80	GX53	(L70B50>)40.000h

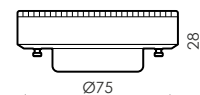

# esSENSE

## Opal smart

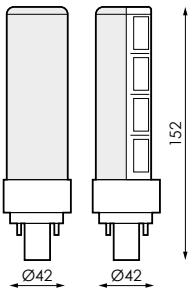

		$W_t$	$\phi$	K		
384384*		12W	1.235lm		3.000K	Ø42 x 152mm
384391*		12W	1.324lm		4.000K	Ø42 x 152mm

\*Hasta fin de existencias/\* Until end of stock/\* Jusqu'à épuisement des stocks/\* Enquanto os estoques durarem

	Hz		$\phi$				
230V ac	50-60Hz	IP20	>0,55	-5°C~+35 °C	140°	>80	G24D-3 (Rotatorio) (L70B50>)25.000h

**N**  
NEW

# esSENSE

## Opal smart

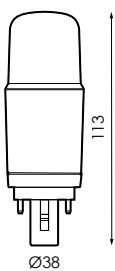

		$W_t$	$\phi$	K		
562768		10W	1.023lm		3.000K	Ø38 x 113mm
562775		10W	1.055lm		4.000K	Ø38 x 113mm

	Hz		$\phi$				
230V ac	50-60Hz	IP20	>0,55	-5°C~+35 °C	140°	>80	G24D-3 (Rotatorio) (L70B50>)25.000h

# spotLINE

360° smart



Barcode	Beam Angle	W <sub>r</sub>	φ	K	Dimensions
476744	F	6W	598lm	3	3.000K Ø23,5 x 78mm
476751	F	6W	601lm	5	5.000K Ø23,5 x 78mm

⚡	Hz	IP	φ	Temp	Beam	Life	Dim	Beam
230V ac	50-60Hz	IP20	>0,5	-5°C~+35 °C	360°	>80	R7S	(L70B50>)40.000h

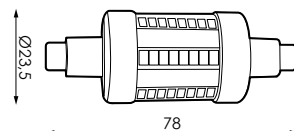

# spotLINE

360° smart



Barcode	Beam Angle	W <sub>r</sub>	φ	K	Dimensions
476768	E	10W	993lm	3	3.000K Ø23,5 x 118mm
476775	E	10W	993lm	5	5.000K Ø23,5 x 118mm

  

⚡	Hz	IP	φ	Temp	Beam	Life	Dim	Beam
230V ac	50-60Hz	IP20	>0,5	-5°C~+35 °C	360°	>80	R7S	(L70B50>)40.000h

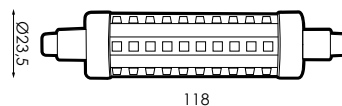

# spotLINE

smart

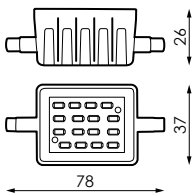

		$W_t$	$\phi$	K		
165648*	A+	6W	503lm	<b>3</b> 3.000K	78 x 37 x 26mm	NO
159890*	A+	6W	597lm	<b>4</b> 4.000K	78 x 37 x 26mm	NO

\*Hasta fin de existencias/\* Until end of stock/\* Jusqu'à épuisement des stocks/\* Enquanto os estoques durarem

	Hz						
230V ac	50-60Hz	IP20	-5°C~+35 °C	120°	>80	R7S	(L70B50>)30.000h

Ñ/ 7,5W Regulable:  
Regulación TRIAC y tradicional  
de incandescencia. E/ 7,5W  
Regulable: TRIAC regulation  
and traditional incandescent.  
F/ 7,5W Réglable: Régulation  
TRIAC et incandescence  
traditionnelle. P/ 7,5W  
Regulável: Regulação TRIAC e  
incandescente tradicional.

# spotLINE

smart

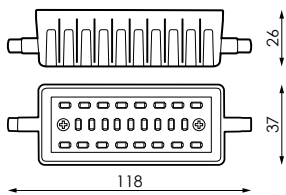

		$W_t$	$\phi$	K		
159920*	A+	7.5W	661lm	<b>4</b> 4.000K	118 x 37 x 26mm	SI
159982*	A+	10W	951lm	<b>3</b> 3.000K	118 x 37 x 26mm	NO

\*Hasta fin de existencias/\* Until end of stock/\* Jusqu'à épuisement des stocks/\* Enquanto os estoques durarem

	Hz						
230V ac	50-60Hz	IP20	-5°C~+35 °C	120°	>80	R7S	(L70B50>)30.000h

# Pebetero

## basic



		$W_r$	$\phi$	K	
482707		2,5W	208lm		3.000K $\varnothing 25 \times 60\text{mm}$
483315		2,5W	217lm		5.000K $\varnothing 25 \times 60\text{mm}$

	Hz			$\Lambda$			
230V ac	50-60Hz	IP20	-5°C~+35 °C	360°	>80	E14	(L70B50)>25.000h



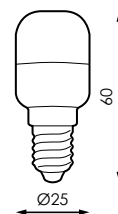

# esSENSE

## Compact smart

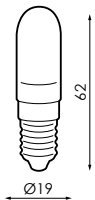

			$W_T$	$\phi$	K	
387187			1,5W	180lm		3.000K $\phi 19 \times 62\text{mm}$
387170			1,5W	192lm		4.200K $\phi 19 \times 62\text{mm}$

	Hz		$\phi$					
230V ac	50-60Hz	IP20	>0,3	-5°C~+35 °C	200°	>80	E14	(L70B50>)25.000h

# iconSTAR

## G4 smart

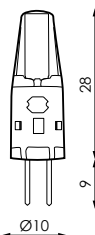

			$W_T$	$\phi$	K	
384193			1,5W	155lm		2.700K $\phi 10 \times 37\text{mm}$
384209			1,5W	167lm		4.200K $\phi 10 \times 37\text{mm}$

	Hz		$\phi$					
12V ac	50-60Hz	IP20	>0,5	-5°C~+35 °C	240°	>80	G4	(L70B50>)30.000h

# iconSTAR

G9 smart



Barcode	Beam Angle	W <sub>r</sub>	φ	K	Dimensions
235488	<b>F</b>	3,5W	356lm	<b>3</b> 3.000K	Ø18 x 60mm
235495	<b>F</b>	3,5W	374lm	<b>5</b> 5.000K	Ø18 x 60mm

⚡	Hz	IP	Temp	Beam	Life	Base	Life
230V ac	50-60Hz	IP20	-5°C~+35 °C	251°	>80	G9	(L70B50>)30.000h

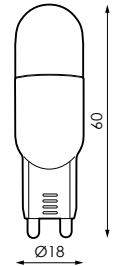

# iconSTAR

G9 basic



Barcode	Beam Angle	W <sub>r</sub>	φ	K	Dimensions
482622	<b>F</b>	4W	353lm	<b>3</b> 3.000K	15 x 7 x 55mm
482639	<b>F</b>	4W	367lm	<b>5</b> 5.000K	15 x 7 x 55mm

⚡	Hz	IP	Temp	Beam	Life	Base	Life
230V ac	50-60Hz	IP20	-5°C~+35 °C	240°	>80	G9	(L70B50>)25.000h



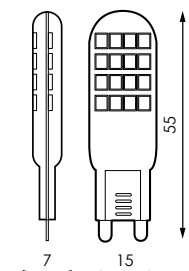

# Accesorios

Accessories

Accessoires

Acessórios

	icon EVO smart GU10	icon EVO smart GU5.3	icon basic GU10	icon basic GU5.3	icon MINI basic	icon PAR 56 20W	icon PAR 56 RGB SINCR0	icon PAR 56 RGB ON/OFF
								
	007931	•		•				
	534062					•	•	•
	534352					•	•	•
	974851	•	•		•			
	164122							•
	442374						•	



007931

Portalámparas halógeno GU5.3  
GU5.3 halogen lampholder  
Douille halogène GU5.3  
Lâmpada halógena GU5.3



974851

Portalámparas halógeno GU10/GZ10 con cable  
Halogen lampholder GU10 / GZ10 with cable  
Douille halogène GU10 / GZ10 avec câble  
Lâmpada de halogéneo GU10 / GZ10 com cabo



442374

Controlador RGB con mando, máx. 20 luminarias (Válido para RGB SINCR0).  
Controller RGB with control, max. 20 luminaires (Valid for RGB SINCR0).  
Contrôleur RGB avec contrôle, max. 20 luminaires (Valide pour RGB SINCR0).  
Controlador RGB com controle, máx. 20 luminárias (Válido para RGB SINCR0).



164122\*

Sincronizador wireless para control RGB con mando a distancia (consultar esquema de conexionado)(Válido para RGB ON/OFF).  
Wireless synchronizer for controlling RGB with remote control(consult the wiring diagram)(Valid for RGB ON/OFF).  
Synchronizer wireless pour contrôle RGB avec télécommande (consultez le schéma de connexion)(Valide pour RGB ON/OFF).  
Sincronizador wireless para control RGB com controle remoto (consulte o esquema da conexão) (Válido para RGB ON/OFF).



534062

Transformador magnético máx. 300W 12V ac IP65. LED  
Magnetic transformer max. 300W 12V ac IP65. LED  
Transformateur magnétique max. 300W 12V ac IP65. LED  
Transformador magnético max. 300W 12V ac IP65. LED



534352

Transformador magnético máx. 500W 12V ac IP65. LED  
Magnetic transformer max. 500W 12V ac IP65. LED  
Transformateur magnétique max. 500W 12V ac IP65. LED  
Transformador magnético max. 500W 12V ac IP65. LED

\*Hasta fin de existencias/\* Until end of stock/\* Jusqu'à épuisement des stocks/\* Enquanto os estoques durarem



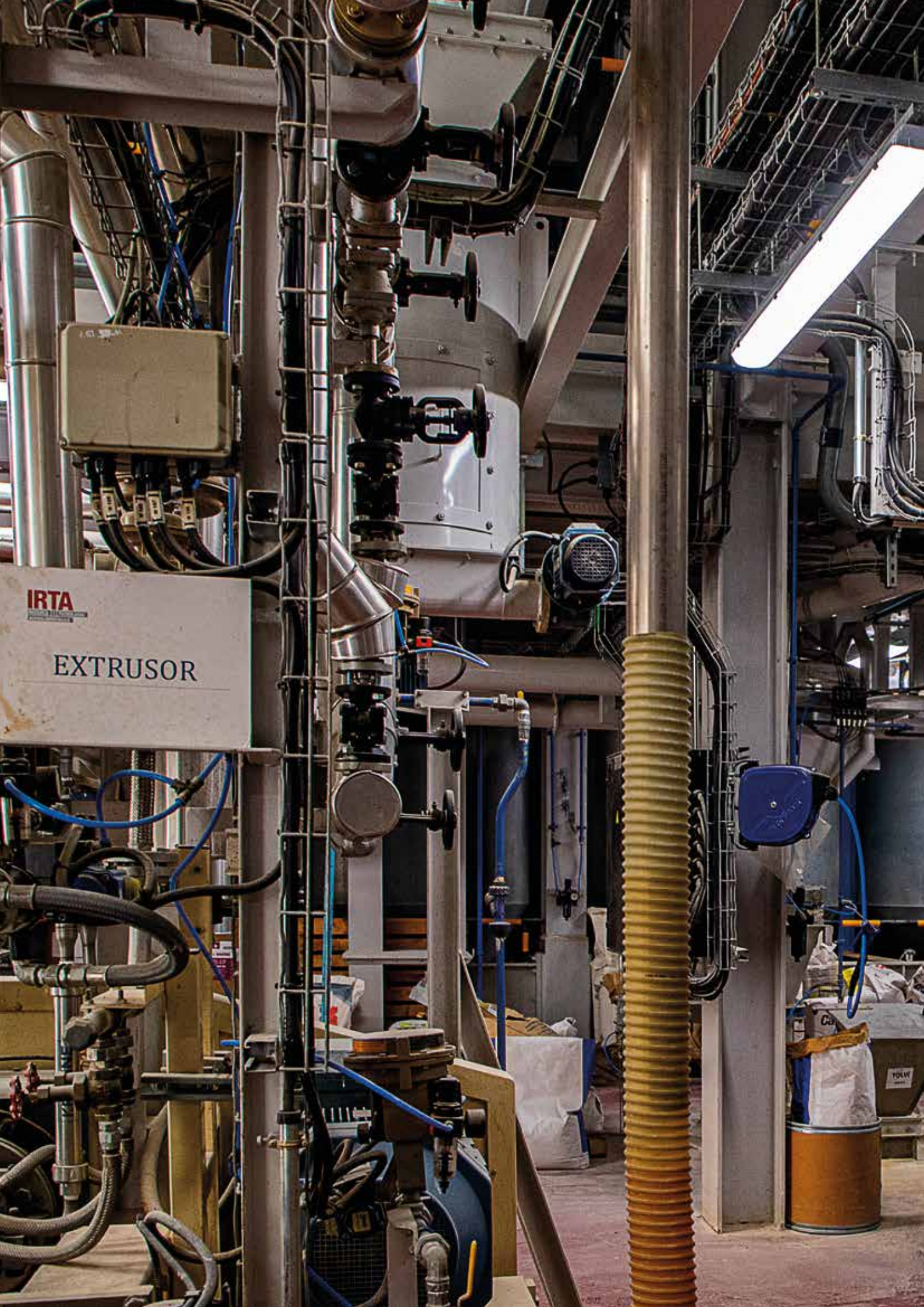

IRTA

EXTRUSOR



Tubos  
Tubes  
Tubes  
Tubos



# ecTUBE T8

Glass smart



**Led Starter Incluido**  
Led Starter Included  
Led Starter Inclus  
Led Starter Incluido

Ñ/ Difusor con recubrimiento de PET, apto para la industria alimenticia. E/ Diffuser with PET coating, suitable for the food industry. F/ Diffuseur avec revêtement en PET, adapté à l'industrie alimentaire. P/ Difusor com revestimento PET, adequado para a indústria alimentar.



		$W_T$	$\phi$	$K$	
458146*		8W	1.096lm		4.000K $\varnothing 28 \times 603\text{mm}$
458153*		8W	1.118lm		6.500K $\varnothing 28 \times 603\text{mm}$
458160*		16W	2.272lm		4.000K $\varnothing 28 \times 1.213\text{mm}$
458177*		16W	2.324lm		6.500K $\varnothing 28 \times 1.213\text{mm}$
458184*		22W	3.078lm		4.000K $\varnothing 28 \times 1.513\text{mm}$
458191*		22W	3.112lm		6.500K $\varnothing 28 \times 1.513\text{mm}$

\*Hasta fin de existencias/\* Until end of stock/\* Jusqu'à épuisement des stocks/\* Enquanto os estoques durarem

	Hz	$\phi$		$\Delta$					
230V ac	50-60Hz	>0,9	-10°C~+45 °C	180°	>80	G13 Rotatorio	(L70B50>) 50.000h	200.000 encendidos	VT-O PET

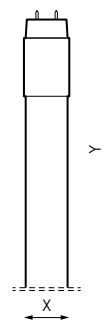



# ecTUBE T8

Glass **basic** NR

**Led Starter Includo**  
 Led Starter Included  
 Led Starter Includo  
 Led Starter Includo

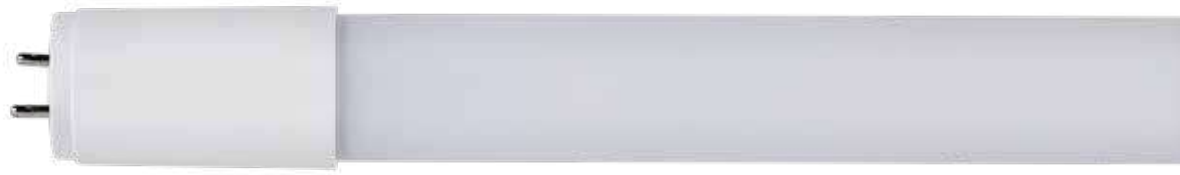

		$W_T$	$\phi_T$	K	
482240		9W	928lm		4.000K Ø28 x 604mm
482257		9W	967lm		6.500K Ø28 x 604mm
482264		18W	1.789lm		4.000K Ø28 x 1.213mm
482271		18W	1.837lm		6.500K Ø28 x 1.213mm
482288		24W	2.435lm		4.000K Ø28 x 1.514mm
482295		24W	2.491lm		6.500K Ø28 x 1.514mm

	Hz	$\phi$		$\Delta$					
230V ac	50-60Hz	>0,9	-5°C~+45 °C	250°	>80	G13 (No rotatorio)	(L70B50>) 30.000h	200.000 encendidos	VT-O







# ecTUBE T8

Glass ECO NR

Led Starter Incluido  
 Led Starter Included  
 Led Starter Includ  
 Led Starter Incluido

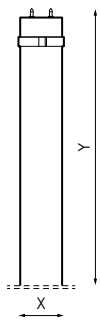

Barcode	Shape	W <sub>T</sub>	φ <sub>T</sub>	K	Dimensions
560672	F	9W	1.013lm	4	4.000K Ø28 x 604mm
560689	F	9W	1.013lm	6,5	6.500K Ø28 x 604mm
560696	F	18W	1.958lm	4	4.000K Ø28 x 1.213mm
560702	F	18W	1.958lm	6,5	6.500K Ø28 x 1.213mm
560719	F	22W	2.463lm	4	4.000K Ø28 x 1.514mm
560726	F	22W	2.463lm	6,5	6.500K Ø28 x 1.514mm

⚡	Hz	φ	🌡️	∠	🌿	🏠	🕒	📦	🔧
230V ac	50-60Hz	>0,5	-20°C~+40 °C	180°	>80	G13 (No rotatorio)	(L70B50>) 15.000h	7.500 encendidos	VT-O







BOUL  
BA





Imagine: Tiras de led

Imagine: Led strips

Imagine: Bandes led

Imagine: Tiras de led

TAPAS FOOD/DRINKS

# Imagine IP65 RGB

Rollo

**N**  
NEW



	$W_t$	$\phi_t$	<b>K</b>				
502764	14,4W	-	<b>R G B</b> RGB	>80	5cm	30.000 x 10mm	30m
	Hz						
24V dc	50-60Hz	CIII	IP65	120°	(L70B50>) 50.000h		

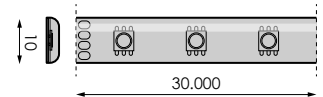

## AVISO / WARNING / AVERTISSEMENT / AVISO

Ñ/ Pérdida de intensidad para más de 10m.

La vida útil de nuestras tiras de led es de 50.000h siempre que la temperatura ambiente no supere los 25°C.

Con el fin de garantizar la vida del led para nuestras tiras  $\geq 9,6W$ , es obligatorio colocarlo sobre una superficie que disipe el calor que generan.

E/ >10m less performance.

The life time of our LED strips is 50.000h as long as the ambient temperature does not exceed 25°C.

To ensure the life of the LED for our strips  $\geq 9,6W$ , it is mandatory to place it on a surface that dissipates the heat they generate.

F/ >10m moins de performance.

La durée de vie de nos bandes de LED est de 50.000h, à condition que la température ambiante ne dépasse pas 25°C.

Afin de garantir la durée de vie des LED de nos barrettes  $\geq 9,6W$ , il est impératif de les placer sur une surface qui dissipe la chaleur qu'elles génèrent.

P/ Perde intensidade para instalações >10m.

A vida útil das nossas fitas LED é de 50.000h, desde que a temperatura ambiente não exceda 25°C.

Para garantir a vida útil do LED para nossas tiras  $\geq 9,6W$ , é obrigatório colocá-lo em uma superfície que dissipe o calor gerado.





# Imagine IP20

Rollo

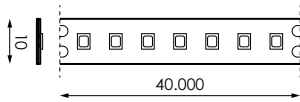

	$W_T$	$\phi$	$K$				
502689	14,4W	1,423lm/m	<b>2,7</b> 2.700K	>80	5cm	40.000 x 10mm	40m
502702	14,4W	1,512lm/m	<b>5</b> 5.000K	>80	5cm	40.000 x 10mm	40m
	Hz			$\Delta$			
24V dc	50-60Hz	CIII	IP20	120°	(L70B50>) 50.000h		

[GRÁFICOS: Unidades en mm/GRAPHICS: Units in mm/GRAPHIQUES: Unités en mm/CRÁFICOS: Unidades em mm]



# Imagine IP65

Rollo

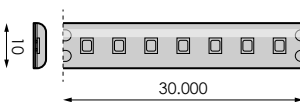

	$W_T$	$\phi$	$K$				
502719	14,4W	1,423lm/m	<b>2,7</b> 2.700K	>80	5cm	30.000 x 10mm	30m
502740	14,4W	1,512lm/m	<b>5</b> 5.000K	>80	5cm	30.000 x 10mm	30m
	Hz			$\Delta$			
24V dc	50-60Hz	CIII	IP65	120°	(L70B50>) 50.000h		

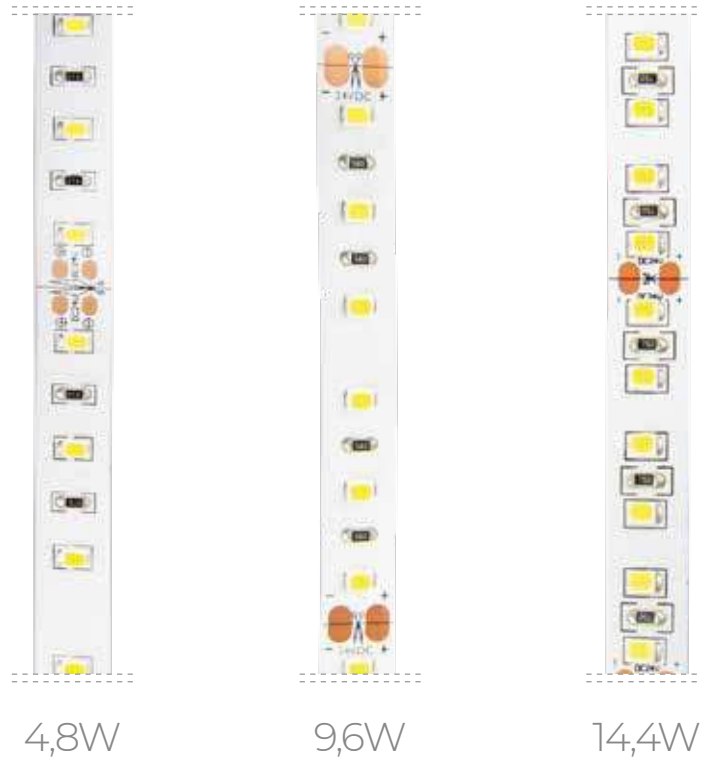

	Hz				
24V dc	50-60Hz	CIII	IP20	120°	(L70B50>) 50.000h

### AVISO / WARNING / AVERTISSEMENT / AVISO

Ñ/ Pérdida de intensidad para más de 10m (4,8W/m-9,6W/m-14,4W/m).

La vida útil de nuestras tiras de led es de 50.000h siempre que la temperatura ambiente no supere los 25°C.

Con el fin de garantizar la vida del led para nuestras tiras  $\geq 9,6W$ , es obligatorio colocarlo sobre una superficie que disipe el calor que generan.

E/ >10m less performance (4,8W/m-9,6W/m- 14,4W/m).

The life time of our LED strips is 50.000h as long as the ambient temperature does not exceed 25°C.

To ensure the life of the LED for our strips  $\geq 9,6W$ , it is mandatory to place it on a surface that dissipates the heat they generate.

F/ >10m moins de performance (4,8W/m-9,6W/m- 14,4W/m).

La durée de vie de nos bandes de LED est de 50.000h, à condition que la température ambiante ne dépasse pas 25°C.

Afin de garantir la durée de vie des LED de nos barrettes  $\geq 9,6W$ , il est impératif de les placer sur une surface qui dissipe la chaleur qu'elles génèrent.

P/ Perde intensidade para instalações >10m (4,8W/m-9,6W/m- 14,4W/m).

A vida útil das nossas fitas LED é de 50.000h, desde que a temperatura ambiente não exceda 25°C.

Para garantir a vida útil do LED para nossas tiras  $\geq 9,6 W$ , é obrigatório colocá-lo em uma superfície que dissipe o calor gerado.

## Imagine IP20 4,8W

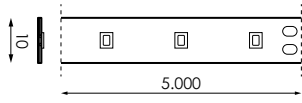

Barcode	W <sub>r</sub>	φ <sub>r</sub>	K	Color	Beam Angle	Length	Height
470810*	4,8W	454lm/m	2,7	2.700K	>80	10cm	5.000x10mm
<b>N</b> 568456	4,8W	454lm/m	2,7	2.700K	>80	10cm	5.000x10mm
470827*	4,8W	480lm/m	4	4.000K	>80	10cm	5.000x10mm
<b>N</b> 568463	4,8W	480lm/m	4	4.000K	>80	10cm	5.000x10mm
470834*	4,8W	496lm/m	5	5.000K	>80	10cm	5.000x10mm
<b>N</b> 568470	4,8W	496lm/m	5	5.000K	>80	10cm	5.000x10mm
470841*	4,8W	503lm/m	6,5	6.500K	>80	10cm	5.000x10mm
<b>N</b> 568487	4,8W	503lm/m	6,5	6.500K	>80	10cm	5.000x10mm
470858*	4,8W	-	Ro	Rojo	>80	10cm	5.000x10mm
470865*	4,8W	-	Ve	Verde	>80	10cm	5.000x10mm
470872*	4,8W	-	Az	Azul	>80	10cm	5.000x10mm
470889*	4,8W	398lm/m	Á	Ámbar	>80	10cm	5.000x10mm

## Imagine IP20 9,6W

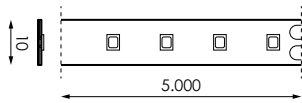

Barcode	W <sub>r</sub>	φ <sub>r</sub>	K	Color	Beam Angle	Length	Height
470896*	9,6W	871lm/m	2,7	2.700K	>80	7,1cm	5.000x10mm
<b>N</b> 568494	9,6W	871lm/m	2,7	2.700K	>80	7,1cm	5.000x10mm
470902*	9,6W	910lm/m	4	4.000K	>80	7,1cm	5.000x10mm
<b>N</b> 568500	9,6W	910lm/m	4	4.000K	>80	7,1cm	5.000x10mm
470919*	9,6W	960lm/m	5	5.000K	>80	7,1cm	5.000x10mm
<b>N</b> 568517	9,6W	960lm/m	5	5.000K	>80	7,1cm	5.000x10mm
470926*	9,6W	993lm/m	6,5	6.500K	>80	7,1cm	5.000x10mm
<b>N</b> 568524	9,6W	993lm/m	6,5	6.500K	>80	7,1cm	5.000x10mm

## Imagine IP20 14,4W

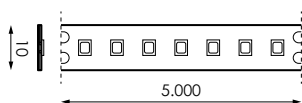

Barcode	W <sub>r</sub>	φ <sub>r</sub>	K	Color	Beam Angle	Length	Height
470933*	14,4W	1.423lm/m	2,7	2.700K	>80	5cm	5.000x10mm
<b>N</b> 568531	14,4W	1.423lm/m	2,7	2.700K	>80	5cm	5.000x10mm
470940*	14,4W	1.482lm/m	4	4.000K	>80	5cm	5.000x10mm
<b>N</b> 568548	14,4W	1.482lm/m	4	4.000K	>80	5cm	5.000x10mm
470957*	14,4W	1.512lm/m	5	5.000K	>80	5cm	5.000x10mm
<b>N</b> 568579	14,4W	1.512lm/m	5	5.000K	>80	5cm	5.000x10mm
470964*	14,4W	1.568lm/m	6,5	6.500K	>80	5cm	5.000x10mm
<b>N</b> 568586	14,4W	1.568lm/m	6,5	6.500K	>80	5cm	5.000x10mm
470971*	14,4W	1.347lm/m	2,7	2.700K	>90	5cm	5.000x10mm
<b>N</b> 568593	14,4W	1.347lm/m	2,7	2.700K	>90	5cm	5.000x10mm
470988*	14,4W	1.431lm/m	4	4.000K	>90	5cm	5.000x10mm
<b>N</b> 568609	14,4W	1.431lm/m	4	4.000K	>90	5cm	5.000x10mm

\*Hasta fin de existencias/ \*Until end of stock/ \*Jusqu'à épuisement des stocks/ \* Enquanto os estoques durarem

# Imagine

IP20

**N**  
NEW

Hasta 5 años de garantía  
Up to 5 years of warranty  
Jusqu'à 5 ans de garantie  
Alé 5 anos de garantia



19,2W



24,5W



	Hz				
24V dc	50-60Hz	CIII	IP20	120°	(L70B50>) 50.000h



Ortopedia Toledo  
Toledo

[GRÁFICOS: Unidades en mm/GRÁFICOS: Units in mm/GRAPHICS: Units in mm/GRÁFICOS: Unidades em mm]

## Imagine IP20 19,2W

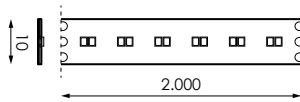
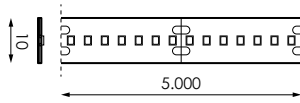

	$W_T$	$\phi_T$	K			
470995*	19,2W	1.513lm/m	2,7	2.700K	>90	5.000x10mm
<b>N</b> 568616	19,2W	1.513lm/m	2,7	2.700K	>90	5.000x10mm
471008*	19,2W	1.600lm/m	4	4.000K	>90	5.000x10mm
<b>N</b> 568630	19,2W	1.600lm/m	4	4.000K	>90	5.000x10mm
471015*	19,2W	1.682lm/m	5	5.000K	>90	5.000x10mm
<b>N</b> 568647	19,2W	1.682lm/m	5	5.000K	>90	5.000x10mm
471022*	19,2W	1.703lm/m	6,5	6.500K	>90	5.000x10mm
<b>N</b> 568654	19,2W	1.703lm/m	6,5	6.500K	>90	5.000x10mm

	$W_T$	$\phi_T$	K			
471077*	19,2W	1.513~1.703lm/m	2.700K~6.500K	>90	2.000x10mm	
<b>N</b> 568708	19,2W	1.513~1.703lm/m	2.700K~6.500K	>90	2.000x10mm	

## Imagine IP20 24,5W

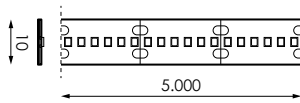

	$W_T$	$\phi_T$	K			
471039*	24,5W	1.728lm/m	2,7	2.700K	>90	5.000x10mm
<b>N</b> 568661	24,5W	1.728lm/m	2,7	2.700K	>90	5.000x10mm
471046*	24,5W	1.817lm/m	4	4.000K	>90	5.000x10mm
<b>N</b> 568678	24,5W	1.817lm/m	4	4.000K	>90	5.000x10mm
471053*	24,5W	1.903lm/m	5	5.000K	>90	5.000x10mm
<b>N</b> 568685	24,5W	1.903lm/m	5	5.000K	>90	5.000x10mm
471060*	24,5W	1.980lm/m	6,5	6.500K	>90	5.000x10mm
<b>N</b> 568692	24,5W	1.980lm/m	6,5	6.500K	>90	5.000x10mm

### AVISO / WARNING / AVERTISSEMENT / AVISO

**N**/ Pérdida de intensidad para más de 5m (19,2W/m - 19,2W/m WAS - 24,5W/m).

La vida útil de nuestras tiras de led es de 50.000h siempre que la temperatura ambiente no supere los 25°C.

Con el fin de garantizar la vida del led para nuestras tiras  $\geq 9,6W$ , es obligatorio colocarlo sobre una superficie que disipe el calor que generan.

**E**/ >5m less performance ((19,2W/m - 19,2W/m WAS - 24,5W/m).

The life time of our LED strips is 50.000h as long as the ambient temperature does not exceed 25°C.

To ensure the life of the LED for our strips  $\geq 9,6W$ , it is mandatory to place it on a surface that dissipates the heat they generate.

**F**/ >5m moins de performance (19,2W/m - 19,2W/m WAS - 24,5W/m).

La durée de vie de nos bandes de LED est de 50.000h, à condition que la température ambiante ne dépasse pas 25°C.

Afin de garantir la durée de vie des LED de nos barrettes  $\geq 9,6W$ , il est impératif de les placer sur une surface qui dissipe la chaleur qu'elles génèrent.

**P**/ Perde intensidade para instalações >5m (19,2W/m - 19,2W/m WAS - 24,5W/m).

A vida útil das nossas fitas LED é de 50.000h, desde que a temperatura ambiente não exceda 25°C.

Para garantir a vida útil do LED para nossas tiras  $\geq 9,6W$ , é obrigatório colocá-lo em uma superfície que dissipe o calor gerado.

\*Hasta fin de existencias/ \*Until end of stock/ \*Jusqu'à épuisement des stocks/ \* Enquanto os estoques durarem

# Imagine

IP65

N  
NEW

Hasta 5 años de garantía  
Up to 5 years of warranty  
Jusqu'à 5 ans de garantie  
Alé 5 anos de garantia



4,8W



9,6W



14,4W



	Hz				
24V dc	50-60Hz	CIII	IP65	120°	(L70B50>) 50.000h



Centro del Ocio  
San Pedro del Pinatar (Murcia)

[GRÁFICOS: Unidades en mm/GRAPHICS: Units in mm/GRÁFICOS: Unidades em mm]



## Imagine IP65 4,8W

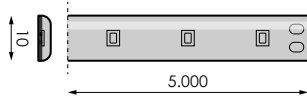

	$W_T$	$\phi_T$	K			
471084*	4,8W	454lm/m	2,7	2.700K	>80	10cm 5.000x10mm
<b>N</b> 568715	4,8W	454lm/m	2,7	2.700K	>80	10cm 5.000x10mm
471091*	4,8W	480lm/m	4	4.000K	>80	10cm 5.000x10mm
<b>N</b> 568722	4,8W	480lm/m	4	4.000K	>80	10cm 5.000x10mm
471107*	4,8W	496lm/m	5	5.000K	>80	10cm 5.000x10mm
<b>N</b> 568739	4,8W	496lm/m	5	5.000K	>80	10cm 5.000x10mm
471114*	4,8W	503lm/m	6,5	6.500K	>80	10cm 5.000x10mm
<b>N</b> 568746	4,8W	503lm/m	6,5	6.500K	>80	10cm 5.000x10mm
471121*	4,8W	-	Ro	Rojo	>80	10cm 5.000x10mm
471138*	4,8W	-	Ve	Verde	>80	10cm 5.000x10mm
471145*	4,8W	-	Az	Azul	>80	10cm 5.000x10mm
471152*	4,8W	398lm/m	Á	Ámbar	>80	10cm 5.000x10mm

## Imagine IP65 9,6W

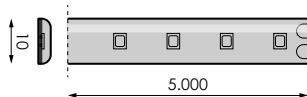

	$W_T$	$\phi_T$	K			
471169*	9,6W	871lm/m	2,7	2.700K	>80	7,1cm 5.000x10mm
<b>N</b> 568753	9,6W	871lm/m	2,7	2.700K	>80	7,1cm 5.000x10mm
471176*	9,6W	910lm/m	4	4.000K	>80	7,1cm 5.000x10mm
<b>N</b> 568999	9,6W	910lm/m	4	4.000K	>80	7,1cm 5.000x10mm
471183*	9,6W	960lm/m	5	5.000K	>80	7,1cm 5.000x10mm
<b>N</b> 569019	9,6W	960lm/m	5	5.000K	>80	7,1cm 5.000x10mm
471190*	9,6W	993lm/m	6,5	6.500K	>80	7,1cm 5.000x10mm
<b>N</b> 569026	9,6W	993lm/m	6,5	6.500K	>80	7,1cm 5.000x10mm

## Imagine IP65 14,4W

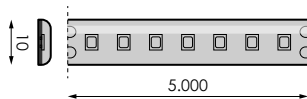

	$W_T$	$\phi_T$	K			
471206*	14,4W	1.423lm/m	2,7	2.700K	>80	5cm 5.000x10mm
<b>N</b> 569033	14,4W	1.423lm/m	2,7	2.700K	>80	5cm 5.000x10mm
471213*	14,4W	1.482lm/m	4	4.000K	>80	5cm 5.000x10mm
<b>N</b> 569040	14,4W	1.482lm/m	4	4.000K	>80	5cm 5.000x10mm
471220*	14,4W	1.512lm/m	5	5.000K	>80	5cm 5.000x10mm
<b>N</b> 569057	14,4W	1.512lm/m	5	5.000K	>80	5cm 5.000x10mm
471237*	14,4W	1.568lm/m	6,5	6.500K	>80	5cm 5.000x10mm
<b>N</b> 569064	14,4W	1.568lm/m	6,5	6.500K	>80	5cm 5.000x10mm

### AVISO / WARNING / AVERTISSEMENT / AVISO

Ñ/ Pérdida de intensidad para más de 10m.

La vida útil de nuestras tiras de led es de 50.000h siempre que la temperatura ambiente no supere los 25°C.

Con el fin de garantizar la vida del led para nuestras tiras  $\geq 9,6W$ , es obligatorio colocarlo sobre una superficie que disipe el calor que generan.

E/ >10m less performance.

The life time of our LED strips is 50.000h as long as the ambient temperature does not exceed 25°C.

To ensure the life of the LED for our strips  $\geq 9,6W$ , it is mandatory to place it on a surface that dissipates the heat they generate.

F/ >10m moins de performance.

La durée de vie de nos bandes de LED est de 50.000h, à condition que la température ambiante ne dépasse pas 25°C.

Afin de garantir la durée de vie des LED de nos barrettes  $\geq 9,6W$ , il est impératif de les placer sur une surface qui dissipe la chaleur qu'elles génèrent.

P/ Perde intensidade para instalações >10m.

A vida útil das nossas fitas LED é de 50.000h, desde que a temperatura ambiente não exceda 25°C.

Para garantir a vida útil do LED para nossas tiras  $\geq 9,6W$ , é obrigatório colocá-lo em uma superfície que dissipe o calor gerado.

\*Hasta fin de existencias/ \*Until end of stock/ \*Jusqu'à épuisement des stocks/ \* Enquanto os estoques durarem

# Imagine

RGB

Hasta 5 años de garantía  
Up to 5 years of warranty  
Jusqu'à 5 ans de garantie  
Alé 5 anos de garantia



IP20  
RGB



IP65  
RGB



IP20  
RGBW



IP65  
RGBW



IP20  
SPI



IP65  
SPI



	Hz			
24V dc	50-60Hz	CIII	120°	(L70B50>) 50.000h

## AVISO / WARNING / AVERTISSEMENT / AVISO

Ñ/ Pérdida de intensidad para más de 10m (7,2W/m-14,4W/m).

Pérdida de intensidad para más de 5m (19,2W/m).

La vida útil de nuestras tiras de led es de 50.000h siempre que la temperatura ambiente no supere los 25°C.

Con el fin de garantizar la vida del led para nuestras tiras  $\geq 9,6W$ , es obligatorio colocarlo sobre una superficie que disipe el calor que generan.

E/ >10m less performance (7,2W/m-14,4W/m).

>5m less performance (19,2W/m).

The life time of our LED strips is 50.000h as long as the ambient temperature does not exceed 25°C.

To ensure the life of the LED for our strips  $\geq 9,6W$ , it is mandatory to place it on a surface that dissipates the heat they generate.

F/ >10m moins de performance (7,2W/m-14,4W/m).

>5m moins de performance (19,2W/m).

La durée de vie de nos bandes de LED est de 50.000h, à condition que la température ambiante ne dépasse pas 25°C.

Afin de garantir la durée de vie des LED de nos barrettes  $\geq 9,6W$ , il est impératif de les placer sur une surface qui dissipe la chaleur qu'elles génèrent.

P/ Perde intensidade para instalações >10m (7,2W/m-14,4W/m).







Perde intensidade para instalações >5m (19,2W/m).

A vida útil das nossas fitas LED é de 50.000h, desde que a temperatura ambiente não exceda 25°C.







Para garantir a vida útil do LED para nossas tiras  $\geq 9,6W$ , é obrigatório colocá-lo em uma superfície que dissipe o calor gerado.

[GRÁFICOS: Unidades en mm/GRÁFICOS: Units in mm/GRAPHICS: Units en mm/GRÁFICOS: Unidades em mm]





# Imagine RGB IP20

	W <sub>T</sub>	K		
471336	7,2W	 RGB	16,5cm	5.000x10mm
471343	14,4W	 RGB	10cm	5.000x10mm
471350	19,2W	 RGBW	10cm	5.000x12mm

# Imagine RGB IP65

	W <sub>T</sub>	K		
471367	7,2W	 RGB	16,5cm	5.000x10mm
471374	14,4W	 RGB	10cm	5.000x10mm
471381	19,2W	 RGBW	10cm	5.000x12mm

# Imagine RGB SPI

	W <sub>T</sub>		K		
471398	14,4W	IP20	 RGB	10cm	5.000x10mm
471404	14,4W	IP65	 RGB	10cm	5.000x10mm

## DIMENSIONES / DIMENSIONS / DIMENSIONS / DIMENSÕES

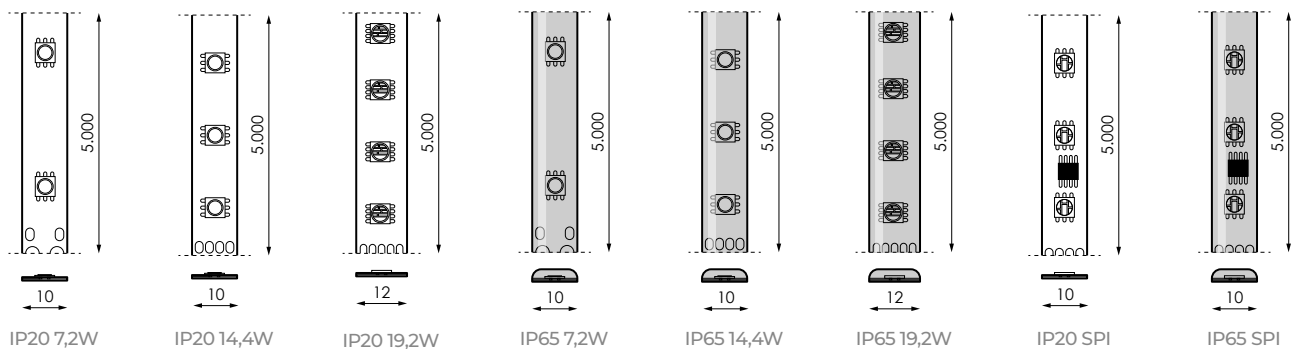

## INFORMACIÓN / INFORMATION / INFORMATION / INFORMAÇÕES

Ñ/ Un pixel por cada 10cm. E/ One pixel for every 10cm. F/ Un pixel pour 10cm. P/ Um pixel para cada 10cm.

# Imagine IP65

Rollo 230V WAS

**N**  
NEW

Hasta 3 años de garantía  
Up to 3 years of warranty  
Jusqu'à 3 ans de garantie  
Alé 3 anos de garantia



	$W_t$	$\phi$	$K$				
590150	10W/m	985~1.105lm/m	2.700K~4.000K	>80	10cm	25.000 x 15mm	25m
	Hz				$\Lambda$		
230V ac	50-60Hz	CI	IP65	-10°C~+40 °C	150°	(L70B50>) 35.000h	PVC

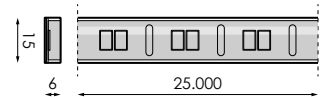

# Imagine IP65

Rollo 230V

**N**  
NEW

Hasta 3 años de garantía  
Up to 3 years of warranty  
Jusqu'à 3 ans de garantie  
Alé 3 anos de garantia



	$W_t$	$\phi$	$K$				
590136	10W/m	995lm/m	<b>3</b> 3.000K	>80	10cm	25.000 x 15mm	25m
590143	10W/m	1.105lm/m	<b>4</b> 4.000K	>80	10cm	25.000 x 15mm	25m
	Hz				$\Lambda$		
230V ac	50-60Hz	CI	IP65	-10°C~+40 °C	150°	(L70B50>) 35.000h	PVC

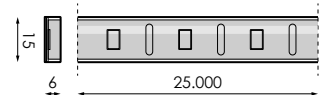

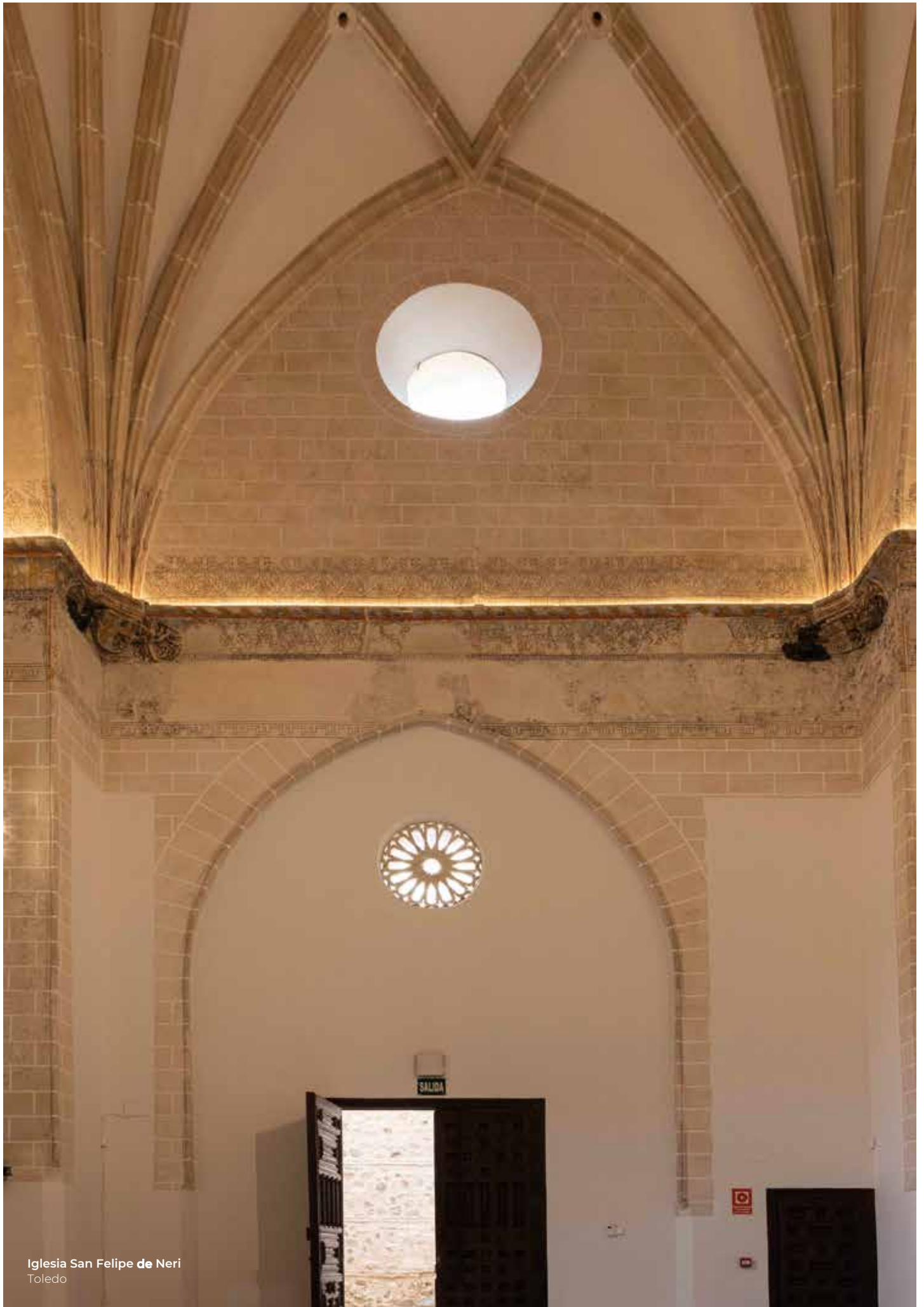

Iglesia San Felipe de Neri  
Toledo



# PROFLEX

## Solución lineal

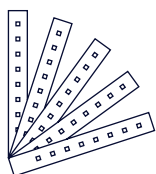

### VARIEDAD IMAGINE

PROFLEX se dispone de multiples posibilidades de combinación con la amplia gama de tiras IMAGINE lo que permiten la personalización del producto según las preferencias del cliente.

PROFLEX offers multiple possibilities of combination with the wide range of IMAGINE strips, which allow the personalization of the product according to the client's preferences.

PROFLEX offre de multiples possibilités de combinaison avec la vaste gamme de bandes IMAGINE, qui permettent de personnaliser le produit en fonction des préférences du client.

PROFLEX dispõe de multiplas possibilidades de combinação com uma ampla gama de fitas IMAGINE que permitem a personalização do produto segundo as preferências do cliente.

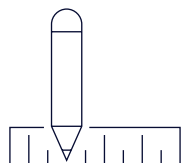

### A MEDIDA

PROFLEX se sirve, en sus diferentes secciones, en longitudes estandar de 100. Existe la posibilidad, bajo pedido, de personalizar la longitud del perfil en medidas que varían según la dimensión de corte de las tiras IMAGINE.

PROFLEX is used, in its different sections, in standard lengths of 100. There is the possibility, on request, to customize the length of the profile in measures that vary according to the cutting dimension of the IMAGINE strips.

PROFLEX est utilisé, dans ses différentes sections, dans des longueurs standard de 100. Il est possible, sur demande, de personnaliser la longueur du profilé dans des mesures qui varient en fonction de la dimension de coupe des bandes IMAGINE.

PROFLEX é fornecido, nas suas diferentes formas, em comprimentos standard de 100cm. Existe a possibilidade, a pedido, de personalizar os comprimentos de perfil a fornecer que variam segundo a dimensao do corte das fitas IMAGINE.

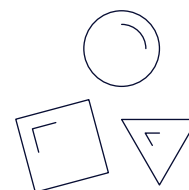

### DIVERSAS APLICACIONES

Disponible en diferentes tipos de secciones y modos de instalación; de superficie (paramentos verticales y horizontales), para esquina y para empotrar.

Available in different types of sections and mode of installation: surface mount (vertical and horizontal parameters), corner and flush mount.

Disponible en différents types de sections et modes d'installation: montage en surface (paramètres verticaux et horizontaux), d'être coin ou encastrement; environnements, des espaces et des meubles.





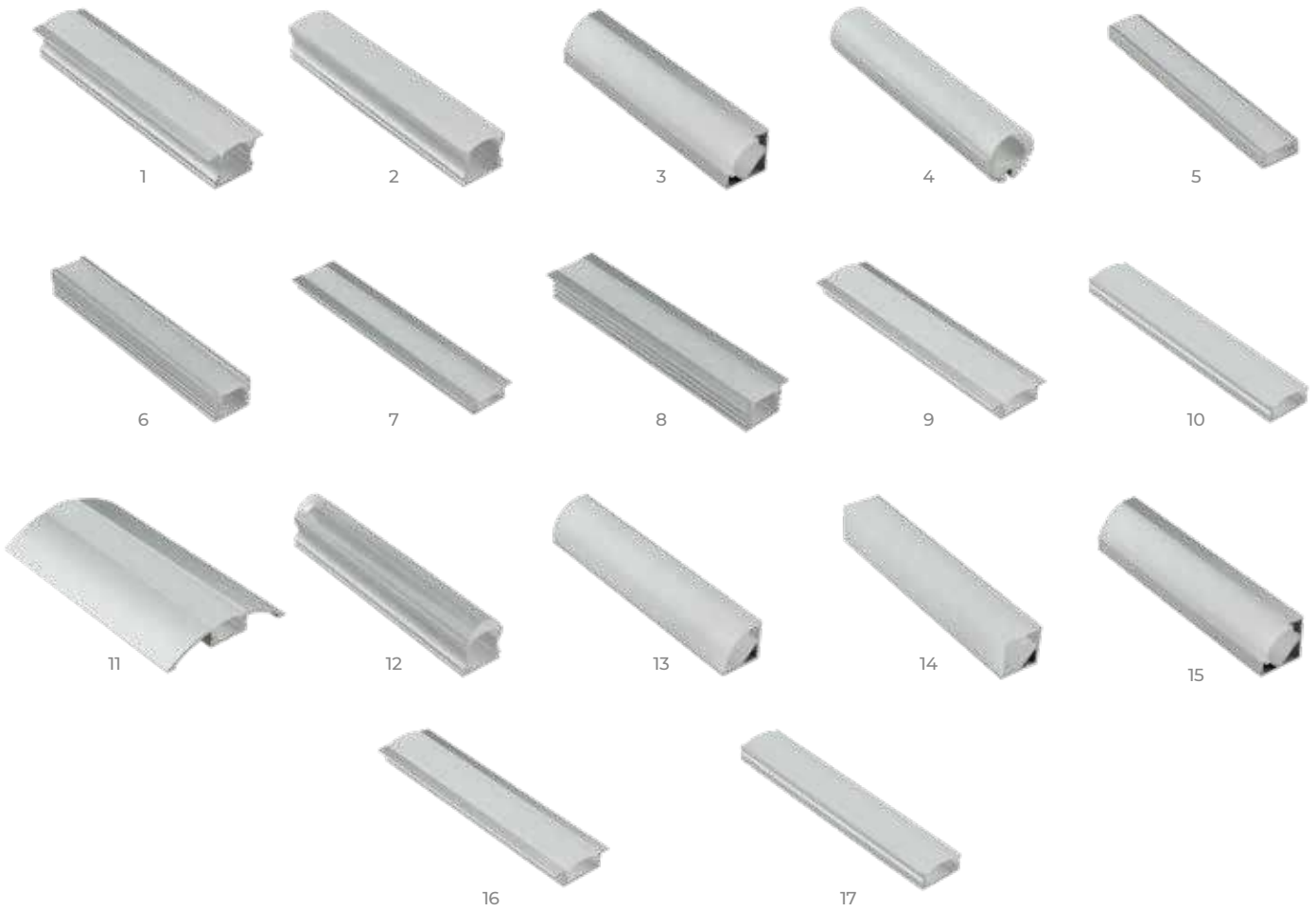

Disponível em diferentes tipos de perfil para diferentes tipos de instalação; de superfície (vertical e horizontal), para canto e para encastramento.



Restaurante La Tarasca  
Toledo



[GRÁFICOS: Unidades en mm/GRAPHS: Units in mm/GRAPHICS: Units in mm/GRÁFICOS: Unidades em mm]

					
482066*	1	Empotrar	2000 x 25 x 16mm	4 Clips aluminio	Tapa inicio/Tapa final
472715*	2	Superficie	2000 x 17,3 x 16mm	4 Clips PVC	Tapa inicio/Tapa final
490887*	3	Esquina	2000 x 18 x 18mm	4 Clips PVC	Tapa inicio/Tapa final
490955*	4	Superficie	2000 x 20,5 x 20mm	4 Clips aluminio	Tapa inicio/Tapa final
472524*	5	Superficie	2000 x 15,9 x 6mm	4 Clips aluminio	Tapa inicio/Tapa final
472586*	6	Superficie	2000 x 16 x 12mm	4 Clips aluminio	Tapa inicio/Tapa final
472623*	7	Empotrar	2000 x 23,3 x 5,7mm	4 Clips aluminio	Tapa inicio/Tapa final
472678*	8	Empotrar	2000 x 16 x 11,7mm	4 Clips aluminio	Tapa inicio/Tapa final
472777*	9	Empotrar	2000 x 25 x 8,1mm	4 Clips aluminio	Tapa inicio/Tapa final
472814*	10	Superficie	2000 x 17,3 x 8,1mm	4 Clips PVC	Tapa inicio/Tapa final
472852*	11	Superficie	2000 x 56,7 x 11,1mm	4 Clips PVC	Tapa inicio/Tapa final
472890*	12	Superficie	2000 x 17,3 x 20,3mm	4 Clips PVC	Tapa inicio/Tapa final
472944*	13	Esquina	2000 x 16 x 16mm	4 Clips PVC	Tapa inicio/Tapa final
473002*	14	Esquina	2000 x 16 x 16mm	4 Clips PVC	Tapa inicio/Tapa final
<b>N</b> 566087	15	Esquina	2000 x 18,5 x 18,5mm	4 Clips	Tapa inicio/Tapa final
<b>N</b> 566100	16	Empotrar	2000 x 17,2 x 9,2mm	4 Clips	Tapa inicio/Tapa final
<b>N</b> 566117	17	Superficie	2000 x 17,2 x 9,2mm	4 Clips	Tapa inicio/Tapa final
					
GR			AL		PC-O





\*Hasta fin de existencias/\* Until end of stock/\* Jusqu'à épuisement des stocks/\* Enquanto os estoques durarem





# Accesorios

Accessories

Accessoires



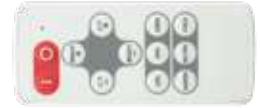

Acessórios

	Imagine IP20	Imagine IP65	Imagine WAS	Imagine IP20 RGB	Imagine IP65 RGB	Imagine IP20 RGBW	Imagine IP65 RGBW	Imagine IP20 SPI RGB	Imagine IP65 SPI RGB	Imagine 230V IP65	Imagine 230V IP65 WAS	
	472395	•	•									
	472401			•								
	472418				•	•						
	472425						•	•				
	472432			•								
	472449				•	•						
	472456						•	•				
	472494								•	•		
	590228										•	
	590235											•
	001253	•	•									
	001437	•	•									
	001662	•	•									
	001663	•	•									
	242813	•		•	•		•		•			
	242820	•		•	•		•		•			
	242837	•		•	•		•		•			
	473682	•	•	•	•	•	•	•	•	•		
	473699	•	•	•	•	•	•	•	•	•		
	487863	•	•									
	487870	•	•									
	487887	•	•									
	487894	•	•									
	492034						•	•				
	492041						•	•				
	499125						•	•				
	473705	•	•	•	•	•	•	•	•	•		
	501453	•	•	•	•	•	•	•	•	•		
	590174										•	•
		209144	•	•								
209151		•	•									
209175					•	•						
209182					•	•						
473040			•									
473057		•										
473064			•									
473071		•										
473101						•						
473118					•							
473125						•						
473132					•							
473149								•				
473156							•					
473163								•				
473170							•					
590181											•	•





	Imagine IP20	Imagine IP65	Imagine WAS	Imagine IP20 RGB	Imagine IP65 RGB	Imagine IP20 RGBW	Imagine IP65 RGBW	Imagine IP20 SPI RGB	Imagine IP65 SPI RGB	Imagine 230V IP65	Imagine 230V IP65 WAS
 590198										•	•
 590204										•	•
 590167										•	•
 590211										•	•



Regulador Imagine  
Imagine regulator  
Régulateur Imagine  
Regulador Imagine





			
472395	5~24V dc	1x5A	51 x 14 x 6mm

Regulador dual Imagine  
Imagine regulator dual  
Régulateur dual Imagine  
Regulador dual Imagine

			
472401	5~24V dc	2x5A	84 x 24 x 15mm







Controlador RGB Imagine  
RGB Imagine controller  
Contrôleur de RGB Imagine  
Controlador de RGB Imagine

			
472418	5~24V dc	3x4A	87 x 24 x 15mm



Controlador RGBW Imagine  
RGBW Imagine controller  
Contrôleur de RGBW Imagine  
Controlador de RGBW Imagine

			
472425	5~24V dc	3x2,5A + 4A	87 x 24 x 15mm



Controlador SPI  
SPI controller  
Contrôleur de SPI  
Controlador de SPI

			
472494	100~240V ac	Hasta 170px	170 x 50 x 23mm

Amplificador Imagine  
Imagine amplifier  
Amplificateur Imagine  
Amplificador Imagine

			
<b>N</b> 515627	5~24V dc	1x10A	87 x 24 x 15mm

[GRÁFICOS: Unidades en mm/GRÁFICOS: Units in mm/GRAPHICS: Unités en mm/GRÁFICOS: Unidades em mm]



Amplificador dual Imagine  
Dual Image amplifier  
Amplificateur dual Imagine  
Amplificador dual Imagine

472432	5~24V dc	2x5A	87 x 24 x 15mm



Amplificador RGB Imagine  
RGB Image amplifier  
Amplificateur RGB Imagine  
Amplificador RGB Imagine

472449	5~24V dc	3x4A	87 x 24 x 15mm



Amplificador RGBW Imagine  
RGBW Image amplifier  
Amplificateur RGBW Imagine  
Amplificador RGBW Imagine

472456	5~24V dc	3x3A + 5A	87 x 21 x 8,5mm



Fuente de alimentación  
Power supply  
Source de courant  
Fonte de energia

	<b>W</b>			
501453	200W	24V dc	IP67	199 x 63 x 35,5mm



Fuente de alimentación  
Power supply  
Source de courant  
Fonte de energia

	<b>W</b>			
473682	60W	24V dc	IP67	162,5 x 42,5 x 32mm
473699	100W	24V dc	IP67	190 x 52 x 37mm
473705	150W	24V dc	IP67	191 x 63 x 37,5mm



Fuente de alimentación  
Power supply  
Source de courant  
Fonte de energia

	<b>W</b>			
242813	60W	24V dc	IP20	115 x 77 x 36mm
242820	150W	24V dc	IP20	205 x 98 x 42mm
242837	250W	24V dc	IP20	205 x 110 x 50mm



Fuente de alimentación DALI  
Power supply DALI  
Source de courant DALI  
Fonte de energia DALI

	<b>W</b>			
<b>N</b> 001662	35W	24V dc	IP20	195 x 43 x 30,2mm
<b>N</b> 001663	60W	24V dc	IP20	225 x 43 x 30,2mm
<b>N</b> 001253	100W	24V dc	IP20	295 x 43 x 30,2mm
<b>N</b> 001437	150W	24V dc	IP20	325 x 43 x 30,2mm



Fuente de alimentación BLUETOOTH  
Power supply BLUETOOTH  
Source de courant BLUETOOTH  
Fonte de energia BLUETOOTH

	<b>W</b>			
<b>N</b> 487863	35W	24V dc	IP20	195 x 43 x 30,2mm
<b>N</b> 487870	60W	24V dc	IP20	225 x 43 x 30,2mm
<b>N</b> 487887	100W	24V dc	IP20	295 x 43 x 30,2mm
<b>N</b> 487894	150W	24V dc	IP20	325 x 43 x 30,2mm





Fuente de alimentación DALI RGBW  
Power supply DALI RGBW  
Source de courant DALI RGBW  
Fonte de energia DALI RGBW

	W	⚡	⊙	↕
<b>N 499071</b>	50W	24V dc	IP20	346 x 32 x 22mm
<b>N 499064</b>	80W	24V dc	IP20	346 x 32 x 22mm

Fuente de alimentación BLUETOOTH RGBW  
Power supply BLUETOOTH RGBW  
Source de courant BLUETOOTH RGBW  
Fonte de energia BLUETOOTH RGBW

	W	⚡	⊙	↕
<b>N 499125</b>	80W	24V dc	IP20	346 x 32 x 22mm



Regulador monocolor LED STRIP  
Single-phase regulator LED STRIP  
Régulateur monophasé LED STRIP  
Regulador de monofásico LED STRIP

	W	⚡
<b>242844*</b>	12V<48W/24V<96W	12/24V dc

Conector  
Connector  
Connecteur  
Conector

	↕
<b>168434* (RGB)</b>	10mm



Conector tira-cable Imagine  
Imagine strip-cable connector  
Connecteur bande-câble Imagine  
Conector tira-cabo Imagine

	⊙	↕
<b>473057</b>	IP20	10mm
<b>473040</b>	IP65	10mm

Conector tira-cable Imagine RGB  
Imagine RGB strip-cable connector  
Connecteur bande-câble Imagine RGB  
Conector tira-cabo Imagine RGB

	⊙	↕
<b>473118</b>	IP20	10mm
<b>473101</b>	IP65	10mm

Conector tira-cable Imagine RGBW  
Imagine RGBW strip-cable connector  
Connecteur bande-câble Imagine RGBW  
Conector tira-cabo Imagine RGBW

	⊙	↕
<b>473156</b>	IP20	12mm
<b>473149</b>	IP65	12mm



Conector tira-tira Imagine  
Imagine strip-strip connector  
Connecteur bande-bande Imagine  
Conector tira-tira Imagine

	⊙	↕
<b>473071</b>	IP20	10mm
<b>473064</b>	IP65	10mm

Conector tira-tira Imagine RGB  
Imagine RGB strip-strip connector  
Connecteur bande-bande Imagine RGB  
Conector tira-tira Imagine RGB

	⊙	↕
<b>473132</b>	IP20	10mm
<b>473125</b>	IP65	10mm

Conector tira-tira Imagine RGBW  
Imagine RGBW strip-strip connector  
Connecteur bande-bande Imagine RGBW  
Conector tira-tira Imagine RGBW

	⊙	↕
<b>473170</b>	IP20	12mm
<b>473163</b>	IP65	12mm

\*Hasta fin de existencias/\* Until end of stock/\* Jusqu'à épuisement des stocks/\* Enquanto os estoques durarem

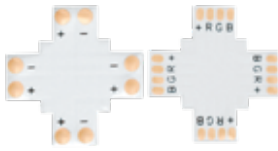

Conector X  
Connector X  
Connecteur X  
Conector X

209151	IP20	10mm
209182 (RGB)	IP20	10mm



Conector T  
Connector T  
Connecteur T  
Conector T

209144	IP20	10mm
209175 (RGB)	IP20	10mm



Conector L  
Connector L  
Connecteur L  
Conector L

209137	IP20	10mm
209168 (RGB)	IP20	10mm

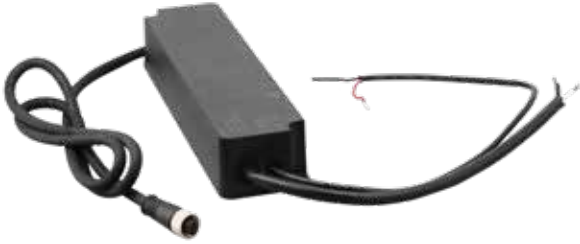

Controlador DALI Imagine  
DALI Imagine controller  
Contrôleur DALI Imagine  
Controlador DALI Imagine

<b>N 590228</b>	250W	200~240V ac	IP65	225 x 56 x 39mm

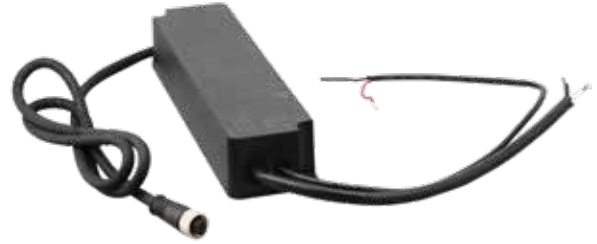

Controlador DALI Imagine WAS  
DALI Imagine controller WAS  
Contrôleur DALI Imagine WAS  
Controlador DALI Imagine WAS

<b>N 590235</b>	250W	200~240V ac	IP65	225 x 56 x 39mm



Cable alimentació  
Power cordon  
Cordon d'alimentation  
Cabo de alimentação

				Blanco
<b>N 590174</b>	IP65	1.500mm	<b>Bl</b>	



Conector  
Connector  
Connecteur  
Conector

<b>N 590181</b>	IP65	500mm



Conector tira-tira  
strip-strip connector  
Connecteur bande-bande  
Conector tira-tira

<b>N 590198</b>	IP65	50 x 21,4 x 11mm



Conector L  
Connector L  
Connecteur L  
Conector L

<b>N 590204</b>	IP65	46,5 x 21,4 x 11mm



Clip de montaje  
Mounting clip  
Clip de montage  
Clipe de montagem



**N 590167**



15 x 20 x 11mm



Tapa final  
End cap  
Embout  
Tampa final



**N 590211**



25,7 x 21,4 x 11mm



# Apliques Lineales

Linear appliques  
Appliques linéaires  
Apliques lineares

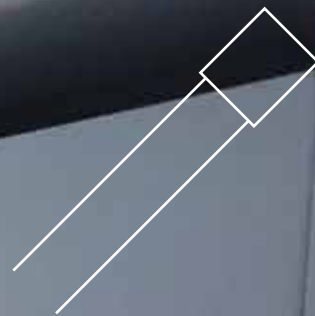



# Softline



Barcode	$W_T$	$\phi_T$	K	Color	Material	Dimensions
441902	25W	2.945lm	4 4.000K	BI Blanco	AL	613 x 120 x 31mm
441919	48W	5.429lm	4 4.000K	BI Blanco	AL	1213 x 120 x 31mm

Input Voltage	Frequency	Protection Class	Ingress Protection	Beam Angle	Life Span	Material	Surface Material
230V ac	50-60Hz	CI	IP20	120°	(L70B50>) 25.000h	AL	PMMA-O

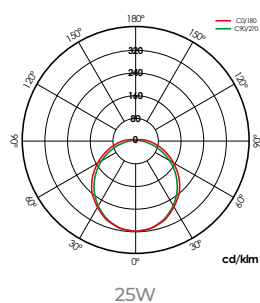
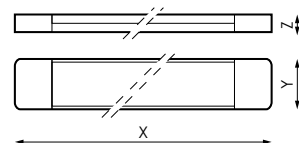

## AVISO/WARNING/AVERTISSEMENT/AVISO

Ñ/ No apto para su exposición a rayos uva.

E/ Not suitable for your exposure to uva rays.

F/ Non adapté à votre exposition aux rayons uva.

P/ Não apropriado para exposição aos raios UV

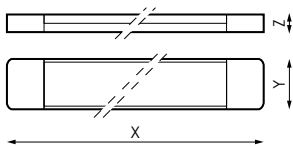

	$W_T$	$\phi_T$	$K$				
441926	20W	2.157lm	<b>4</b>	4.000K	<b>BI</b>	Blanco	597 x 80 x 31mm
441933	35W	3.956lm	<b>4</b>	4.000K	<b>BI</b>	Blanco	1197 x 80 x 31mm
	<b>Hz</b>						
230V ac	50-60Hz	Cl	IP20	120°	(L70B50>) 25.000h	AL	PC-O

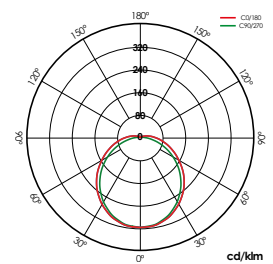

35W

AVISO/WARNING/AVERTISSEMENT/AVISO

Ñ/ No apto para su exposición a rayos uva.

E/ Not suitable for your exposure to uva rays.

F/ Non adapté à votre exposition aux rayons uva.

P/ Não apropriado para exposição aos raios UV

# Segmenta



Barcode	W <sub>T</sub>	φ <sub>T</sub>	K	⊙	↕
441940*	1 x 9W	876lm	<b>4</b> 4.000K <b>BI</b>	Blanco	584 x 29 x 35mm
441957*	1 x 18W	1.921lm	<b>4</b> 4.000K <b>BI</b>	Blanco	1.193 x 29 x 35mm
441964*	2 x 9W	1.954lm	<b>4</b> 4.000K <b>BI</b>	Blanco	584 x 80 x 35mm
441971*	2 x 18W	3.903lm	<b>4</b> 4.000K <b>BI</b>	Blanco	1.193 x 80 x 35mm

\*Hasta fin de existencias/\* Until end of stock/\* Jusqu'à épuisement des stocks/\* Enquanto os estoques durarem

⚡	Hz	□	⊙	∠	⏏	▨
100-265V ac	50-60Hz	CII	IP20	160°	(L70B50>) 25.000h	VT-O PET

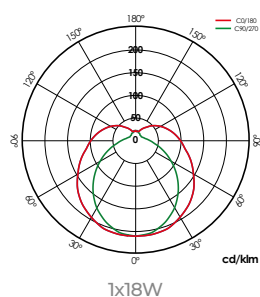
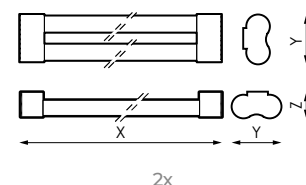
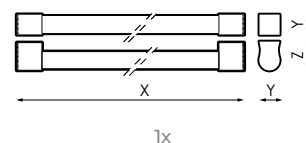

# Slimline LED

## NEO

Luminaria Empalmable  
Linkable Luminary  
Luminaire Empalmable  
Luminária linear de junção

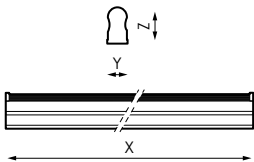

	$W_T$	$\phi_T$	$K$		
233958*	16W	2.004lm	<b>6.5</b> 6.500K	<b>BI</b> Blanco	1.200 x 25 x 35mm
233972*	20W	2.645lm	<b>6.5</b> 6.500K	<b>BI</b> Blanco	1.500 x 25 x 35mm

\*Hasta fin de existencias/\* Until end of stock/\* Jusqu'à épuisement des stocks/\* Enquanto os estoques durarem

	Hz								
230V ac	50-60Hz	CII	IP44	122°	(L70B50>) 30.000h	AL	PC-O	20m lineales	1m Empalme 15cm



# Slimline LED

## AVANT



**Luminaria Empalmable**  
Linkable Luminary  
Luminaire Empalmable  
Luminária linear de junção



	W <sub>T</sub>	φ <sub>T</sub>	K	⊙	↔
548564	4W	413lm	<b>3</b>	3.000K	<b>Bl</b> Blanco 325 x 24 x 38mm
548571	4W	450lm	<b>4</b>	4.000K	<b>Bl</b> Blanco 325 x 24 x 38mm
548588	4W	450lm	<b>6,5</b>	6.500K	<b>Bl</b> Blanco 325 x 24 x 38mm
548595	10W	930lm	<b>3</b>	3.000K	<b>Bl</b> Blanco 585 x 24 x 38mm
548601	10W	1.020lm	<b>4</b>	4.000K	<b>Bl</b> Blanco 585 x 24 x 38mm
548618	10W	1.020lm	<b>6,5</b>	6.500K	<b>Bl</b> Blanco 585 x 24 x 38mm
548625	14W	1.370lm	<b>3</b>	3.000K	<b>Bl</b> Blanco 885 x 24 x 38mm
548632	14W	1.460lm	<b>4</b>	4.000K	<b>Bl</b> Blanco 885 x 24 x 38mm
548649	14W	1.460lm	<b>6,5</b>	6.500K	<b>Bl</b> Blanco 885 x 24 x 38mm
548656	18W	1.830lm	<b>3</b>	3.000K	<b>Bl</b> Blanco 1.185 x 24 x 38mm
548663	18W	1.925lm	<b>4</b>	4.000K	<b>Bl</b> Blanco 1.185 x 24 x 38mm
548670	18W	1.925lm	<b>6,5</b>	6.500K	<b>Bl</b> Blanco 1.185 x 24 x 38mm
548687	23W	2.378lm	<b>3</b>	3.000K	<b>Bl</b> Blanco 1.498 x 24 x 38mm
548694	23W	2.430lm	<b>4</b>	4.000K	<b>Bl</b> Blanco 1.498 x 24 x 38mm
548700	23W	2.430lm	<b>6,5</b>	6.500K	<b>Bl</b> Blanco 1.498 x 24 x 38mm

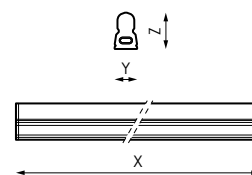

	Hz									
230V ac	50-60Hz	CII	IP20	160°	(L70B50>) 30.000h	PC	PC-O	20m lineales	1m	Empalme 15cm

### ACCESORIOS/ACCESSORIES/ACCESSOIRES/ACESSÓRIOS



548717

Kit accesorios



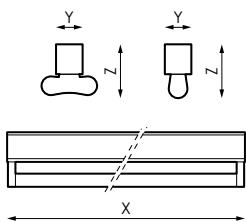

	$W_T$				
233125	1x	ecTUBE LED 600mm	<b>BI</b>	Blanco 615 x 50 x 67mm	
233132	1x	ecTUBE LED 1.200mm	<b>BI</b>	Blanco 1.225 x 50 x 67mm	
233149	1x	ecTUBE LED 1.500mm	<b>BI</b>	Blanco 1.525 x 50 x 67mm	
233156	2x	ecTUBE LED 600mm	<b>BI</b>	Blanco 615 x 50 x 72mm	
233163	2x	ecTUBE LED 1.200mm	<b>BI</b>	Blanco 1.225 x 50 x 72mm	
233170	2x	ecTUBE LED 1.500mm	<b>BI</b>	Blanco 1.525 x 50 x 72mm	
	Hz				
230V ac	50-60Hz	CI	IP20	G13	AL

BAJO PEDIDO / ON REQUEST / SUR COMMANDE / A PEDIDO



### Conexión del tubo por ambos extremos y conexión a un extremo sin polaridad.

Tube connection by both extremes and connection to one end without polarity.

Connexion du tube par les deux extrêmes et connexion à une extrémité sans polarité.

Conexão do tubo por ambos extremos e conexão para uma extremidade sem polaridade.

AVISO / WARNING / AVERTISSEMENT / AVISO

Ñ/ Tubo no incluido.

E/ Not included tube.

F/ Tube non incluse.

P/ Tubo não incluído.



LE OUE E T A B O I A



# Downlights



# Magnet



Apertura Magnética\*  
Magnetic Opening\*  
Ouverture Magnétique\*  
Abertura Magnética\*



Barcode	W <sub>T</sub>	Φ <sub>T</sub>	K	Color
483346*	12W	867lm	3	3.000K Gr Gris
483353*	12W	942lm	4	4.000K Gr Gris
483360*	12W	867lm	3	3.000K Bl Blanco
483377*	12W	942lm	4	4.000K Bl Blanco
483384*	12W	867lm	3	3.000K N Negro
483391*	12W	942lm	4	4.000K N Negro

\*Hasta fin de existencias/\* Until end of stock/\* Jusqu'à épuisement des stocks/\* Enquanto os estoques durarem

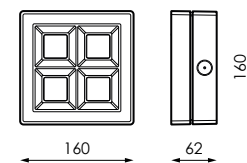

Lightning Bolt	Hz	Φ	□	⊙	⚡	⚡	⚡	⚡	⚡
220-240V ac	50-60Hz	> 0,9	CII	IP20	IK08	100°	>80	(L70B50>) 50.000h	PC

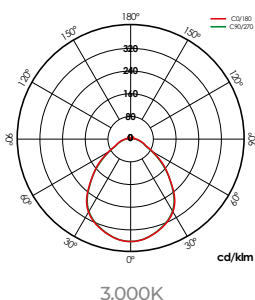

## \*AVISO / \*WARNING / \*AVERTISSEMENT / \*AVISO

Ñ/ Apertura magnética sin necesidad de herramientas.

E/ Magnetic opening without tools.

F/ Ouverture magnétique sans outils.

P/ Abertura magnética sem ferramentas.





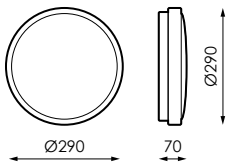

Barcode	W <sub>t</sub>	Icon	Φ <sub>r</sub>	K	Color	Color Name
402019	20W	80mA	1.905lm	3	3.000K	Blanco
402026	20W	80mA	1.991lm	4	4.000K	Blanco
402033*	20W	80mA	1.905lm	3	3.000K	Gris
402040*	20W	80mA	1.991lm	4	4.000K	Gris
388849	30W	140mA	2.854lm	3	3.000K	Blanco
388856	30W	140mA	2.992lm	4	4.000K	Blanco
388863*	30W	140mA	2.854lm	3	3.000K	Gris

\*Hasta fin de existencias/\* Until end of stock/\* Jusqu'à épuisement des stocks/\* Enquanto os estoques durarem

	Hz								
220-240V ac	50-60Hz	CII	IP40	-10°C~+45 °C	125°	>80	(L70B50>) 25.000h	PC-O	AL

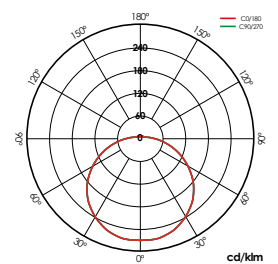

4.000K





Barcode	W <sub>T</sub>	Φ	φ	K	Dimensions
495844	36W	>0,9	2.736lm	<b>3</b>	3.000K Ø430 x 74mm
495851	36W	>0,9	2.916lm	<b>4</b>	4.000K Ø430 x 74mm
495899	50W	>0,9	3.811lm	<b>3</b>	3.000K Ø530 x 71mm
495905	50W	>0,9	4.052lm	<b>4</b>	4.000K Ø530 x 71mm

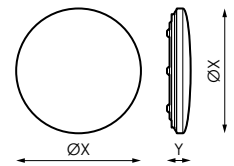

	Hz							
220-240V ac	50-60Hz	CI	IP20	125°	>80 (L70B50>) 25.000h	BL	PMMA-O	AL

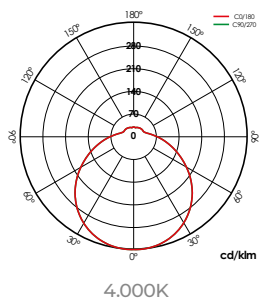

## ACCESORIOS / ACCESSOIRES / ACCESSORIES / ACESSÓRIOS

+ INFO PAG. 146



495868

Aro decorativo Blanco 36W



495875

Aro decorativo Negro 36W



495882

Aro decorativo Madera 36W

495912

Aro decorativo Blanco 50W

495929

Aro decorativo Negro 50W

495936

Aro decorativo Madera 50W

# Viessa Sensor

Sensor de Presencia y Luminosidad (microondas)  
 Presence and Brightness Sensor (microwave)  
 Présence et Capteur de Lumière (micro-ondes)  
 Presença e sensor de luz (microondas)

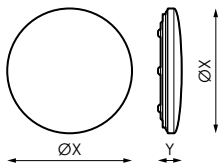

	W <sub>r</sub>	Φ	Φ	K	↕
470124	20W	>0,7	1.477lm	<b>3</b>	3.000K Ø330 x 62mm
470131	20W	>0,7	1.528lm	<b>4</b>	4.000K Ø330 x 62mm
470148	30W	>0,9	2.197lm	<b>3</b>	3.000K Ø380 x 68mm
470155	30W	>0,9	2.253lm	<b>4</b>	4.000K Ø380 x 68mm

	Hz								
220-240V ac	50-60Hz	CI	IP44	125°	>80	(L70B50>) 25.000h	BL	PMMA-O	AL

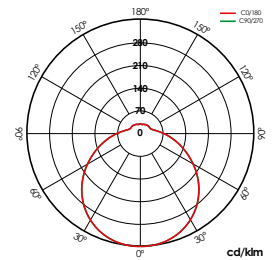

4.000K



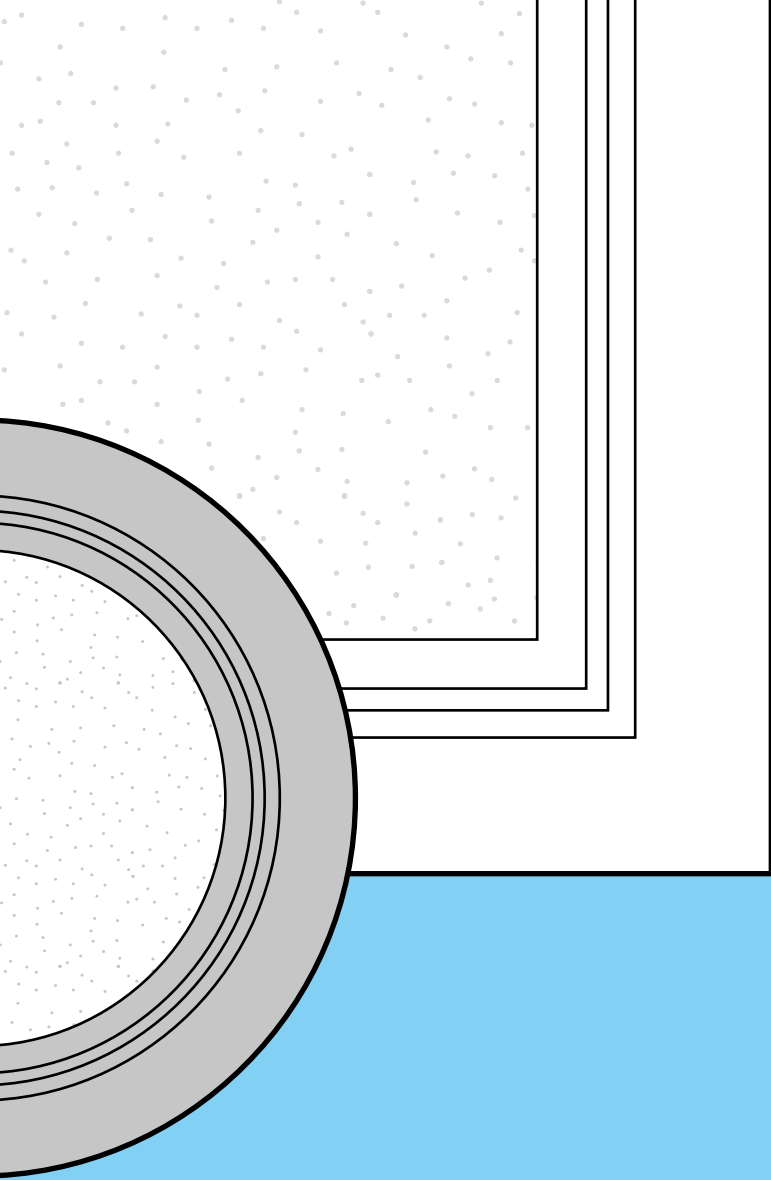

Kentau CL



Kentau SQ

		20W	14W	9W	6W	20W	14W	9W	6W
K	3.000K	•	•	•	•	•	•	•	•
	4.000K	•	•	•	•	•	•	•	•
	5.000K	•							
	6.500K	•							
	Blanco	•	•	•	•	•	•	•	•
	RAL 9006	•	•	•	•	•	•	•	•
	1-10V	•	•	•	•	•	•	•	•
	CTOUCH	•	•			•	•		
		•	•			•	•		
	Blanco	•	•	•		•	•	•	
	RAL 9006	•	•	•		•	•	•	

# El mejor downlight se llama

# Kentau



Fácil instalación

Tecnología CELLTECH

Driver extraíble e intercambiable

Diseño compacto

Montaje versátil

Diseño sencillo, puro, elegante

E/ Easy installation. CELLTECH technology.  
Driver removable and interchangeable.  
Compact design. Versatile built-in.  
Simple, pure, elegant design.

F/ Installation facile. Technologie CELLTECH.  
Amovible du pilote et interchangeable.  
Design compact. Polyvalent.  
Pure, design simple et élégant.

P/ Fácil instalação. Tecnologia CELLTECH.  
Driver removível e intercambiável.  
Desenho compacto. Montagem versátil.  
Desenho simples, puro, elegante.

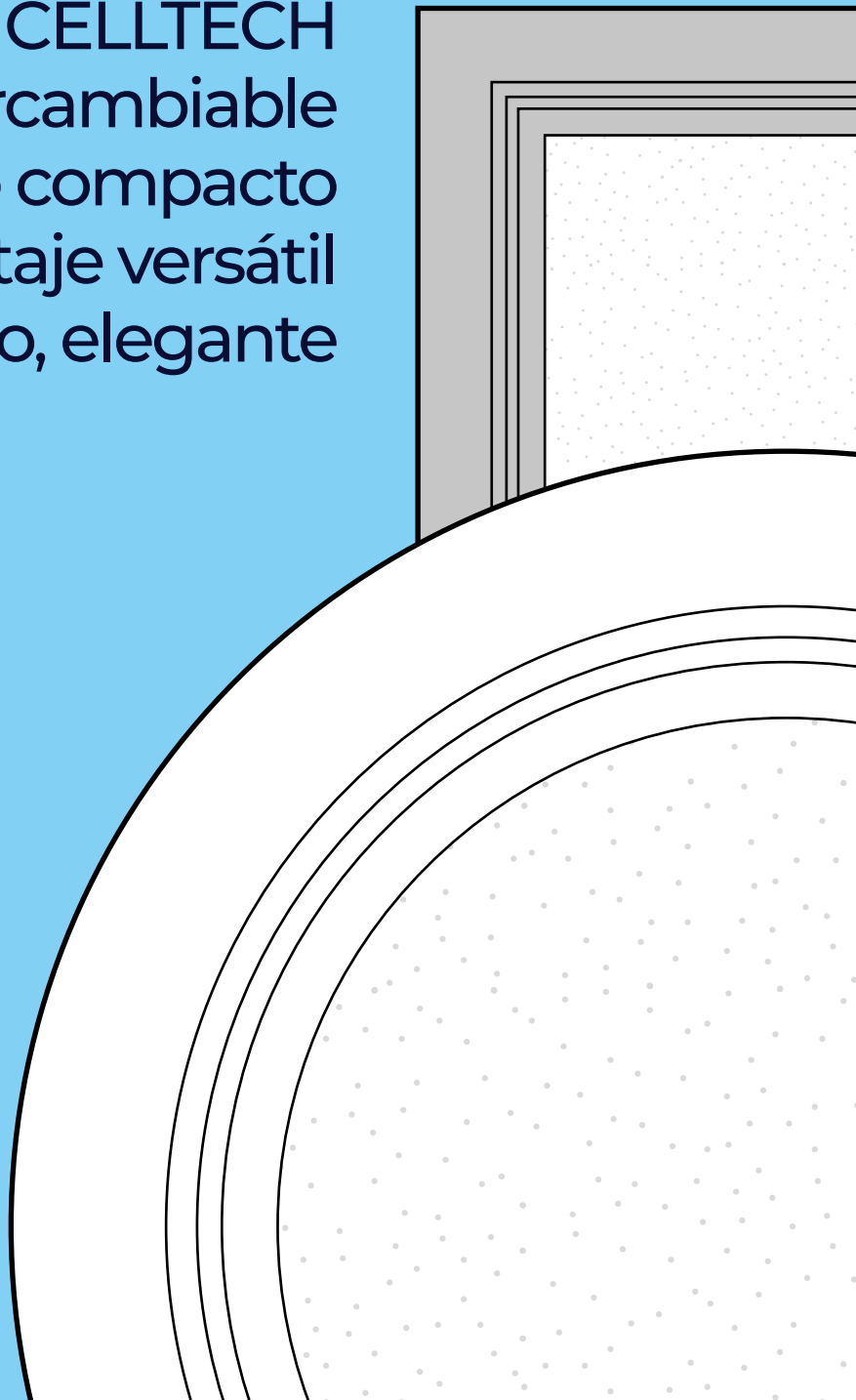

# Kentau CL



**N**  
NEW



Hasta 5 años de garantía  
Up to 5 years of warranty  
Jusqu'à 5 ans de garantie  
Alé 5 anos de garantia

Soluciones  
Solutions  
Des solutions  
Soluções

Pack BLUETOOTH  
Pág.38

Pack CTE  
Pág.30

Pack Aulas  
Pág.34



Necesita driver DALI  
You need DALI driver  
Vous avez besoin d'un driver DALI  
Você precisa da driver DALI

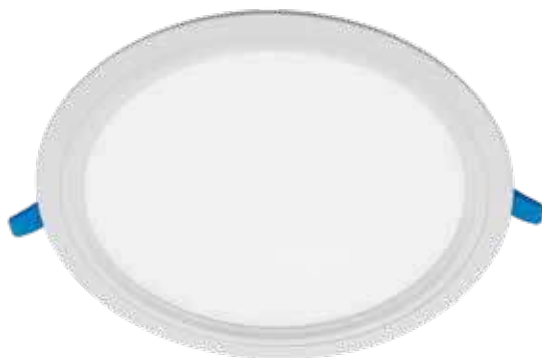

Ñ/ Fácil instalación. Tecnología CELLTECH. Driver extraíble e intercambiable. Diseño compacto. Montaje versátil, empotrable o superficie. Diseño sencillo, puro, elegante.

E/ Easy installation. CELLTECH technology. Driver removable and interchangeable. Compact design. Versatile, built-in or surface assembly. Simple, pure, elegant design.

F/ Installation facile. Technologie CELLTECH. Amovible du pilote et interchangeable. Design compact. Polyvalent, dans la construction ou l'assemblage de surface. Pure, design simple et élégant.

P/ Fácil instalação. Tecnologia CELLTECH. Driver removível e intercambiável. Desenho compacto. Montagem versátil, encastrada ou saliente. Desenho simples, puro, elegante.



	Hz								
180-250V ac	50-60Hz	CII	IP20	IP40	-5°C~+35°C	120°	(L70B50>) 50.000h	PC-O	AL

BAJO PEDIDO / ON REQUEST / SUR COMMANDE / A PEDIDO



**DALI** (Sólo 20W/14W)



### Kit de emergencia 2h (Excepto superficie)

Emergency kit 2h (Except surface)

Kit d'urgence 2h (Sauf surface)

Kit de emergência 2h (Exceto superfície)

[GRÁFICOS: Unidades en mm/GRÁFICOS: Units in mm/GRAPHICS: Units in mm/GRÁFICOS: Unidades em mm/GRÁFICOS: Units in mm/GRAPHICS: Units in mm/GRÁFICOS: Unidades em mm]



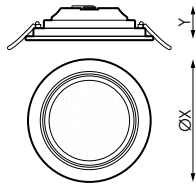

		W <sub>T</sub>	☼	φ	K	∞	↔	↕	⊙		
<b>N 527293</b>		20W	>80	2.339lm	<b>4</b>	4.000K	<b>Bl</b>	Blanco	∅225 x 30mm	∅200-210mm	<b>DALI</b>
<b>N 527309</b>		14W	>80	1.551lm	<b>4</b>	4.000K	<b>Bl</b>	Blanco	∅175 x 30mm	∅150-155mm	<b>DALI</b>
543071*		20W	>80	2.249lm	<b>4</b>	4.000K	<b>Bl</b>	Blanco	∅225 x 30mm	∅200-210mm	CTOUCH
532143		20W	>80	2.339lm	<b>4</b>	4.000K	<b>Bl</b>	Blanco	∅225 x 30mm	∅200-210mm	1-10V
532150		14W	>80	1.551lm	<b>4</b>	4.000K	<b>Bl</b>	Blanco	∅175 x 30mm	∅150-155mm	1-10V
532167		9W	>80	1.017lm	<b>4</b>	4.000K	<b>Bl</b>	Blanco	∅150 x 30mm	∅125-130mm	1-10V
532174		6W	>80	635lm	<b>4</b>	4.000K	<b>Bl</b>	Blanco	∅125 x 30mm	∅100-110mm	1-10V
381413		20W	>80	2.198lm	<b>3</b>	3.000K	<b>Gr</b>	RAL 9006	∅225 x 30mm	∅200-210mm	NO
381420		20W	>80	2.339lm	<b>4</b>	4.000K	<b>Gr</b>	RAL 9006	∅225 x 30mm	∅200-210mm	NO
381437		20W	>80	2.198lm	<b>3</b>	3.000K	<b>Bl</b>	Blanco	∅225 x 30mm	∅200-210mm	NO
381444		20W	>80	2.339lm	<b>4</b>	4.000K	<b>Bl</b>	Blanco	∅225 x 30mm	∅200-210mm	NO
408202		20W	>80	2.488lm	<b>5</b>	5.000K	<b>Bl</b>	Blanco	∅225 x 30mm	∅200-210mm	NO
408219		20W	>80	2.556lm	<b>6,5</b>	6.500K	<b>Bl</b>	Blanco	∅225 x 30mm	∅200-210mm	NO
381468		14W	>80	1.476lm	<b>3</b>	3.000K	<b>Gr</b>	RAL 9006	∅175 x 30mm	∅150-155mm	NO
381451		14W	>80	1.551lm	<b>4</b>	4.000K	<b>Gr</b>	RAL 9006	∅175 x 30mm	∅150-155mm	NO
381482		14W	>80	1.476lm	<b>3</b>	3.000K	<b>Bl</b>	Blanco	∅175 x 30mm	∅150-155mm	NO
381475		14W	>80	1.551lm	<b>4</b>	4.000K	<b>Bl</b>	Blanco	∅175 x 30mm	∅150-155mm	NO
381505		9W	>80	996lm	<b>3</b>	3.000K	<b>Gr</b>	RAL 9006	∅150 x 30mm	∅125-130mm	NO
381499		9W	>80	1.017lm	<b>4</b>	4.000K	<b>Gr</b>	RAL 9006	∅150 x 30mm	∅125-130mm	NO
381529		9W	>80	996lm	<b>3</b>	3.000K	<b>Bl</b>	Blanco	∅150 x 30mm	∅125-130mm	NO
381512		9W	>80	1.017lm	<b>4</b>	4.000K	<b>Bl</b>	Blanco	∅150 x 30mm	∅125-130mm	NO
381543		6W	>80	609lm	<b>3</b>	3.000K	<b>Gr</b>	RAL 9006	∅125 x 30mm	∅100-110mm	NO
381536		6W	>80	635lm	<b>4</b>	4.000K	<b>Gr</b>	RAL 9006	∅125 x 30mm	∅100-110mm	NO
381567		6W	>80	609lm	<b>3</b>	3.000K	<b>Bl</b>	Blanco	∅125 x 30mm	∅100-110mm	NO
381550		6W	>80	635lm	<b>4</b>	4.000K	<b>Bl</b>	Blanco	∅125 x 30mm	∅100-110mm	NO

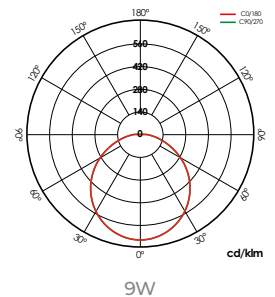

ACCESORIOS / ACCESSOIRES / ACCESSORIES / ACESSÓRIOS  
+ INFO PAG.146



	W <sub>T</sub>	∞
387590	20W	<b>Gr</b> RAL 9006
387583	20W	<b>Bl</b> Blanco
387576	14W	<b>Gr</b> RAL 9006
387569	14W	<b>Bl</b> Blanco
387552	9W	<b>Gr</b> RAL 9006
387545	9W	<b>Bl</b> Blanco

	W <sub>T</sub>	⊙
<b>N 507325</b>	20W	<b>DALI</b>
<b>N 507332</b>	14W	<b>DALI</b>
543125*	14W	CTOUCH
532181	20W	1-10V
532198	14W	1-10V
532204	9W	1-10V
532211	6W	1-10V

\*Hasta fin de existencias/\* Until end of stock/\* Jusqu'à épuisement des stocks/\* Enquanto os estoques durarem

# Kentau SQ



**N**  
NEW



Hasta 5 años de garantía  
Up to 5 years of warranty  
Jusqu'à 5 ans de garantie  
Alé 5 anos de garantia

Soluciones  
Solutions  
Des solutions  
Soluções

Pack BLUETOOTH  
Pág.38

Pack CTE  
Pág.30

Pack Aulas  
Pág.34



Necesita driver DALI  
You need DALI driver  
Vous avez besoin d'un driver DALI  
Você precisa da driver DALI



Ñ/ Fácil instalación. Tecnología CELLTECH. Driver extraíble e intercambiable. Diseño compacto. Montaje versátil, empotrable o superficie. Diseño sencillo, puro, elegante.

E/ Easy installation. CELLTECH technology. Driver removable and interchangeable. Compact design. Versatile, built-in or surface assembly. Simple, pure, elegant design.

F/ Installation facile. Technologie CELLTECH. Amovible du pilote et interchangeable. Design compact. Polyvalent, dans la construction ou l'assemblage de surface. Pure, design simple et élégant.

P/ Fácil instalação. Tecnologia CELLTECH. Driver removível e intercambiável. Desenho compacto. Montagem versátil, encastrada ou saliente. Desenho simples, puro, elegante.



	Hz									
180-250V ac	50-60Hz	CII	IP20	IP40	-5°C~+35°C	120°	>80	(L70B50>) 50.000h	PC-O	AL

BAJO PEDIDO / ON REQUEST / SUR COMMANDE / A PEDIDO



**DALI** (Sólo 20W/14W)



**Kit de emergencia 2h (Excepto superficie)**

Emergency kit 2h (Except surface)  
Kit d'urgence 2h (Sauf surface)  
Kit de emergência 2h (Exceto superfície)

[GRÁFICOS: Unidades en mm/GRÁFICOS: Units in mm/GRAPHIQUES: Unités en mm/GRÁFICOS: Unidades em mm]

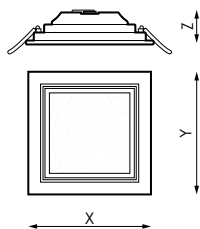

	$W_T$	$\phi$	K				
387538	20W	2.140lm	<b>3</b> 3.000K	<b>Gr</b>	RAL 9006	225 x 225 x 30mm	200 x 200mm
381383	20W	2.303lm	<b>4</b> 4.000K	<b>Gr</b>	RAL 9006	225 x 225 x 30mm	200 x 200mm
381406	20W	2.140lm	<b>3</b> 3.000K	<b>Bl</b>	Blanco	225 x 225 x 30mm	200 x 200mm
381390	20W	2.303lm	<b>4</b> 4.000K	<b>Bl</b>	Blanco	225 x 225 x 30mm	200 x 200mm
387514	14W	1.471lm	<b>3</b> 3.000K	<b>Gr</b>	RAL 9006	175 x 175 x 30mm	150 x 150mm
387521	14W	1.537lm	<b>4</b> 4.000K	<b>Gr</b>	RAL 9006	175 x 175 x 30mm	150 x 150mm
387491	14W	1.471lm	<b>3</b> 3.000K	<b>Bl</b>	Blanco	175 x 175 x 30mm	150 x 150mm
387507	14W	1.537lm	<b>4</b> 4.000K	<b>Bl</b>	Blanco	175 x 175 x 30mm	150 x 150mm
387477	9W	967lm	<b>3</b> 3.000K	<b>Gr</b>	RAL 9006	150 x 150 x 30mm	125 x 125mm
387484	9W	1.012lm	<b>4</b> 4.000K	<b>Gr</b>	RAL 9006	150 x 150 x 30mm	125 x 125mm
387453	9W	967lm	<b>3</b> 3.000K	<b>Bl</b>	Blanco	150 x 150 x 30mm	125 x 125mm
387460	9W	1.012lm	<b>4</b> 4.000K	<b>Bl</b>	Blanco	150 x 150 x 30mm	125 x 125mm
387439	6W	587lm	<b>3</b> 3.000K	<b>Gr</b>	RAL 9006	125 x 125 x 30mm	100 x 100mm
387446	6W	613lm	<b>4</b> 4.000K	<b>Gr</b>	RAL 9006	125 x 125 x 30mm	100 x 100mm
387415	6W	587lm	<b>3</b> 3.000K	<b>Bl</b>	Blanco	125 x 125 x 30mm	100 x 100mm
387422	6W	613lm	<b>4</b> 4.000K	<b>Bl</b>	Blanco	125 x 125 x 30mm	100 x 100mm

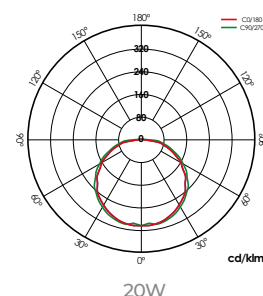

## ACCESORIOS / ACCESSOIRES / ACCESSORIES / ACESSÓRIOS

+ INFO PAG. 146



	$W_T$		
387651	20W	<b>Gr</b>	RAL 9006
387644	20W	<b>Bl</b>	Blanco
387637	14W	<b>Gr</b>	RAL 9006
387620	14W	<b>Bl</b>	Blanco
387613	9W	<b>Gr</b>	RAL 9006
387606	9W	<b>Bl</b>	Blanco

	$W_T$	
<b>N</b> 507325	20W	
<b>N</b> 507332	14W	
543125*	14W	CTOUCH
532181	20W	1-10V
532198	14W	1-10V
532204	9W	1-10V
532211	6W	1-10V

# Breno CL

Soluciones  
Solutions  
Des solutions  
Soluções

Pack BLUETOOTH  
Pág.38

Pack CTE  
Pág.30

Pack Aulas  
Pág.34



Necesita driver DALI  
You need DALI driver  
Vous avez besoin d'un driver DALI  
Você precisa da driver DALI



Breno CL



Ñ/ Módulo PCB fabricado en aluminio para favorecer la disipación de temperatura. Placa de policarbonato interna para mejorar la reflexión lumínica. Luz perimetral. E/ PCB Module made in aluminium in order to make easily the dissipation of temperature. Internal polycarbonate board to improve the light reflection. Perimetral light. F/ Module PCB réalisée en aluminium afin de faire facilement la dissipation de température. Plaque interne de polycarbonate pour améliorer le reflect de la lumière. Lumière périmétrique. P/ Módulo PCB feito em alumínio, a fim de facilitar a dissipação de temperatura. Placa interna de policarbonato para melhorar o reflexo da luz. Luz perimetral.



Breno CL Superficie



220-240V ac	50-60Hz	CII	IP20	120°	>80	(L70B50>) 35.000h	PS	AL

[GRÁFICOS: Unidades en mm/GRÁFICOS: Units in mm/GRAPHICS: Units in mm/GRAPHIQUES: Unités en mm/GRÁFICOS: Unidades em mm]

# Breno CL

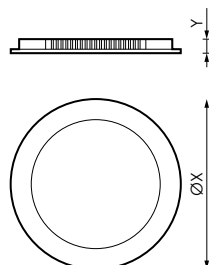

	$W_T$	$\phi_T$	$K$					
482820	6W	338lm	<b>3</b>	3.000K	<b>Bl</b>	Blanco	Ø90 x 18mm	Ø75mm
482837	6W	359lm	<b>4</b>	4.000K	<b>Bl</b>	Blanco	Ø90 x 18mm	Ø75mm
482844	6W	338lm	<b>3</b>	3.000K	<b>Gr</b>	RAL 9006	Ø90 x 18mm	Ø75mm
482851	6W	359lm	<b>4</b>	4.000K	<b>Gr</b>	RAL 9006	Ø90 x 18mm	Ø75mm
482868	9W	511lm	<b>3</b>	3.000K	<b>Bl</b>	Blanco	Ø120 x 18mm	Ø105mm
482875	9W	544lm	<b>4</b>	4.000K	<b>Bl</b>	Blanco	Ø120 x 18mm	Ø105mm
482882	9W	511lm	<b>3</b>	3.000K	<b>Gr</b>	RAL 9006	Ø120 x 18mm	Ø105mm
482899	9W	544lm	<b>4</b>	4.000K	<b>Gr</b>	RAL 9006	Ø120 x 18mm	Ø105mm
482905	12W	929lm	<b>3</b>	3.000K	<b>Bl</b>	Blanco	Ø170 x 18mm	Ø160mm
482912	12W	984lm	<b>4</b>	4.000K	<b>Bl</b>	Blanco	Ø170 x 18mm	Ø160mm
482929	12W	929lm	<b>3</b>	3.000K	<b>Gr</b>	RAL 9006	Ø170 x 18mm	Ø160mm
482936	12W	984lm	<b>4</b>	4.000K	<b>Gr</b>	RAL 9006	Ø170 x 18mm	Ø160mm
482943	18W	1.385lm	<b>3</b>	3.000K	<b>Bl</b>	Blanco	Ø225 x 18mm	Ø205mm
482950	18W	1.458lm	<b>4</b>	4.000K	<b>Bl</b>	Blanco	Ø225 x 18mm	Ø205mm
482967	18W	1.535lm	<b>6,5</b>	6.500K	<b>Bl</b>	Blanco	Ø225 x 18mm	Ø205mm
482974	18W	1.385lm	<b>3</b>	3.000K	<b>Gr</b>	RAL 9006	Ø225 x 18mm	Ø205mm
482981	18W	1.458lm	<b>4</b>	4.000K	<b>Gr</b>	RAL 9006	Ø225 x 18mm	Ø205mm

# Breno CL Superficie

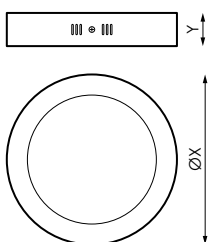

	$W_T$	$\phi_T$	$K$				
482998	18W	1.385lm	<b>3</b>	3.000K	<b>Bl</b>	Blanco	Ø225 x 39mm
483001	18W	1.458lm	<b>4</b>	4.000K	<b>Bl</b>	Blanco	Ø225 x 39mm
483018	18W	1.385lm	<b>3</b>	3.000K	<b>Gr</b>	RAL 9006	Ø225 x 39mm
483025	18W	1.458lm	<b>4</b>	4.000K	<b>Gr</b>	RAL 9006	Ø225 x 39mm
483797	24W	1.850lm	<b>3</b>	3.000K	<b>Bl</b>	Blanco	Ø300 x 39mm
483803	24W	1.956lm	<b>4</b>	4.000K	<b>Bl</b>	Blanco	Ø300 x 39mm
483810	24W	1.850lm	<b>3</b>	3.000K	<b>Gr</b>	RAL 9006	Ø300 x 39mm
483827	24W	1.956lm	<b>4</b>	4.000K	<b>Gr</b>	RAL 9006	Ø300 x 39mm

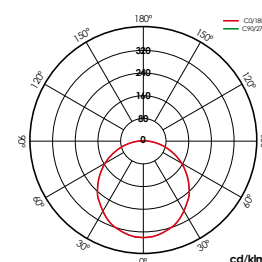

18W/3.000K

BAJO PEDIDO / ON REQUEST / SUR COMMANDE / A PEDIDO



## Kit de emergencia 1h (Excepto superficie)

Emergency kit 1h (Except surface)

Kit d'urgence 1h (Sauf surface)

Kit de emergência 1h (Exceto superfície)



# Breno SQ

Soluciones Solutions Des solutions Soluções
Pack BLUETOOTH Pág.38
Pack CTE Pág.30
Pack Aulas Pág.34
 Necesita driver DALI You need DALI driver Vous avez besoin d'un driver DALI Você precisa da driver DALI



Breno SQ











Ñ/ Módulo PCB fabricado en aluminio para favorecer la disipación de temperatura. Placa de policarbonato interna para mejorar la reflexión lumínica. Luz perimetral. E/ PCB Module made in aluminium in order to make easily the dissipation of temperature. Internal polycarbonate board to improve the light reflection. Perimetral light. F/ Module PCB réalisée en aluminium afin de faire facilement la dissipation de température. Plaque interne de polycarbonate pour améliorer le reflect de la lumière. Lumière périmétrique. P/ Módulo PCB feito em alumínio, a fim de facilitar a dissipação de temperatura. Placa interna de policarbonato para melhorar o reflexo da luz. Luz perimetral.



Breno SQ Superficie



								
220-240V ac	50-60Hz	CII	IP20	120°	>80	(L70B50>) 35.000h	PS	AL

[GRÁFICOS: Unidades en mm/GRÁFICOS: Units in mm/GRAPHICS: Units en mm/GRÁFICOS: Unidades em mm]

# Breno SQ

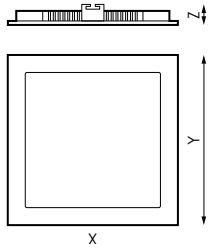

	$W_T$	$\phi$	K				
483032	6W	338lm	<b>3</b> 3.000K	<b>Bl</b>	Blanco	85 x 85 x 22mm	75 x 75mm
483049	6W	359lm	<b>4</b> 4.000K	<b>Bl</b>	Blanco	85 x 85 x 22mm	75 x 75mm
483056	6W	338lm	<b>3</b> 3.000K	<b>Gr</b>	RAL 9006	85 x 85 x 22mm	75 x 75mm
483063	6W	359lm	<b>4</b> 4.000K	<b>Gr</b>	RAL 9006	85 x 85 x 22mm	75 x 75mm
483070	9W	511lm	<b>3</b> 3.000K	<b>Bl</b>	Blanco	120 x 120 x 18mm	105 x 105mm
483087	9W	544lm	<b>4</b> 4.000K	<b>Bl</b>	Blanco	120 x 120 x 18mm	105 x 105mm
483094	9W	511lm	<b>3</b> 3.000K	<b>Gr</b>	RAL 9006	120 x 120 x 18mm	105 x 105mm
483100	9W	544lm	<b>4</b> 4.000K	<b>Gr</b>	RAL 9006	120 x 120 x 18mm	105 x 105mm
483117	12W	929lm	<b>3</b> 3.000K	<b>Bl</b>	Blanco	170 x 170 x 18mm	160 x 160mm
483124	12W	984lm	<b>4</b> 4.000K	<b>Bl</b>	Blanco	170 x 170 x 18mm	160 x 160mm
483131	12W	929lm	<b>3</b> 3.000K	<b>Gr</b>	RAL 9006	170 x 170 x 18mm	160 x 160mm
483148	12W	984lm	<b>4</b> 4.000K	<b>Gr</b>	RAL 9006	170 x 170 x 18mm	160 x 160mm
483155	18W	1.385lm	<b>3</b> 3.000K	<b>Bl</b>	Blanco	225 x 225 x 18mm	205 x 205mm
483162	18W	1.458lm	<b>4</b> 4.000K	<b>Bl</b>	Blanco	225 x 225 x 18mm	205 x 205mm
483179	18W	1.385lm	<b>3</b> 3.000K	<b>Gr</b>	RAL 9006	225 x 225 x 18mm	205 x 205mm
483186	18W	1.458lm	<b>4</b> 4.000K	<b>Gr</b>	RAL 9006	225 x 225 x 18mm	205 x 205mm

# Breno SQ Superficie

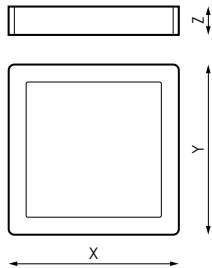

	$W_T$	$\phi$	K				
483193	18W	1.385lm	<b>3</b> 3.000K	<b>Bl</b>	Blanco	225 x 225 x 39mm	
483209	18W	1.458lm	<b>4</b> 4.000K	<b>Bl</b>	Blanco	225 x 225 x 39mm	
483216	18W	1.385lm	<b>3</b> 3.000K	<b>Gr</b>	RAL 9006	225 x 225 x 39mm	
483223	18W	1.458lm	<b>4</b> 4.000K	<b>Gr</b>	RAL 9006	225 x 225 x 39mm	
483834	24W	1.850lm	<b>3</b> 3.000K	<b>Bl</b>	Blanco	300 x 300 x 39mm	
483841	24W	1.956lm	<b>4</b> 4.000K	<b>Bl</b>	Blanco	300 x 300 x 39mm	
483858	24W	1.850lm	<b>3</b> 3.000K	<b>Gr</b>	RAL 9006	300 x 300 x 39mm	
483865	24W	1.956lm	<b>4</b> 4.000K	<b>Gr</b>	RAL 9006	300 x 300 x 39mm	

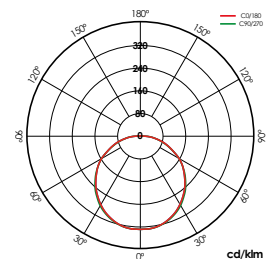

18W 3.000K

BAJO PEDIDO / ON REQUEST / SUR COMMANDE / A PEDIDO



## Kit de emergencia 1h (Excepto superficie)

Emergency kit 1h (Except surface)

Kit d'urgence 1h (Sauf surface)

Kit de emergência 1h (Exceto superfície)

# Breno CL

basic







	Hz							
220-240V ac	50-60Hz	CII	IP20	120°	>80	(L70B50>) 25.000h	PC	PC

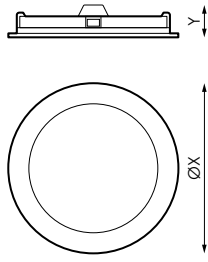

IES Serpis  
Valencia



[GRÁFICOS: Unidades en mm/ GRAPHICS: Units in mm/GRAPHIQUES: Unités en mm/GRÁFICOS: Unidades em mm]



	$W_T$	$\phi_T$	$K$					
590471	6W	568lm	<b>3</b>	3.000K	<b>BI</b>	Blanco	Ø115 x 29,5mm	Ø100mm
590488	6W	587lm	<b>4</b>	4.000K	<b>BI</b>	Blanco	Ø115 x 29,5mm	Ø100mm
590495	6W	602lm	<b>6,5</b>	6.500K	<b>BI</b>	Blanco	Ø115 x 29,5mm	Ø100mm
590501	12W	1.203lm	<b>3</b>	3.000K	<b>BI</b>	Blanco	Ø175 x 29,5mm	Ø150mm
590518	12W	1.289lm	<b>4</b>	4.000K	<b>BI</b>	Blanco	Ø175 x 29,5mm	Ø150mm
590525	12W	1.317lm	<b>6,5</b>	6.500K	<b>BI</b>	Blanco	Ø175 x 29,5mm	Ø150mm
590532	18W	1.798lm	<b>3</b>	3.000K	<b>BI</b>	Blanco	Ø225 x 29,5mm	Ø200mm
590549	18W	1.851lm	<b>4</b>	4.000K	<b>BI</b>	Blanco	Ø225 x 29,5mm	Ø200mm
590556	18W	1.913lm	<b>6,5</b>	6.500K	<b>BI</b>	Blanco	Ø225 x 29,5mm	Ø200mm

ACCESORIOS / ACCESSOIRES / ACCESSORIES / ACESSÓRIOS  
+ INFO PAG. 146



	$W_T$			
590587	18W	<b>BI</b>	Blanco	225x32mm
590570	12W	<b>BI</b>	Blanco	175x32mm
590563	6W	<b>BI</b>	Blanco	115x32mm

# Breno PC



	W <sub>T</sub>	φ <sub>T</sub>		K		⊙
553605*	18W	1.578lm	<b>3</b>	3.000K	<b>Bl</b>	Blanco
553612*	18W	1.639lm	<b>4</b>	4.000K	<b>Bl</b>	Blanco
553629*	18W	1.720lm	<b>6,5</b>	6.500K	<b>Bl</b>	Blanco
553636*	18W	1.578lm	<b>3</b>	3.000K	<b>Gr</b>	RAL 9006
553643*	18W	1.639lm	<b>4</b>	4.000K	<b>Gr</b>	RAL 9006

\*Hasta fin de existencias/\* Until end of stock/\* Jusqu'à épuisement des stocks/\* Enquanto os estoques durarem

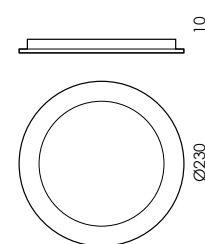

	Hz								
220-240V ac	50-60Hz	CII	IP20	120°	>80	(L70B50>) 25.000h	PC-O	PC	Ø205mm

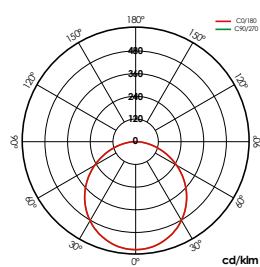

18W

## ACCESORIOS / ACCESSOIRES / ACCESSORIES / ACESSÓRIOS

+ INFO PAG.146



553667

Accesorio superficie blanco



553674

Accesorio superficie RAL 9006

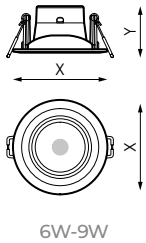

	W <sub>T</sub>	φ <sub>T</sub>	K				
483445	6W	513lm	<b>3</b> 3.000K	<b>Bl</b>	Blanco	Ø85 x 46mm	Ø70mm
483452	6W	573lm	<b>4</b> 4.000K	<b>Bl</b>	Blanco	Ø85 x 46mm	Ø70mm
483520	6W	513lm	<b>3</b> 3.000K	<b>Gr</b>	Gris	Ø85 x 46mm	Ø70mm
483537	6W	573lm	<b>4</b> 4.000K	<b>Gr</b>	Gris	Ø85 x 46mm	Ø70mm
483469	9W	842lm	<b>3</b> 3.000K	<b>Bl</b>	Blanco	Ø105 x 54mm	Ø83mm
483476	9W	916lm	<b>4</b> 4.000K	<b>Bl</b>	Blanco	Ø105 x 54mm	Ø83mm
483544	9W	842lm	<b>3</b> 3.000K	<b>Gr</b>	Gris	Ø105 x 54mm	Ø83mm
483551	9W	916lm	<b>4</b> 4.000K	<b>Gr</b>	Gris	Ø105 x 54mm	Ø83mm

	Hz	φ							
220-240V ac	50-60Hz	> 0,5	CII	IP20	25°	>80	(L70B50>) 25.000h	24°	PC

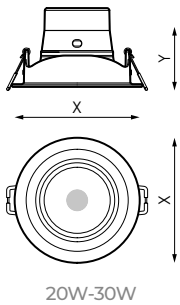

	W <sub>T</sub>	φ <sub>T</sub>	K				
483483*	20W	1.733lm	<b>3</b> 3.000K	<b>Bl</b>	Blanco	Ø140 x 85mm	Ø117mm
483490*	20W	1.811lm	<b>4</b> 4.000K	<b>Bl</b>	Blanco	Ø140 x 85mm	Ø117mm
483568*	20W	1.733lm	<b>3</b> 3.000K	<b>Gr</b>	Gris	Ø140 x 85mm	Ø117mm
483575*	20W	1.811lm	<b>4</b> 4.000K	<b>Gr</b>	Gris	Ø140 x 85mm	Ø117mm
483506*	30W	2.779lm	<b>3</b> 3.000K	<b>Bl</b>	Blanco	Ø170 x 98mm	Ø147mm
483513*	30W	2.856lm	<b>4</b> 4.000K	<b>Bl</b>	Blanco	Ø170 x 98mm	Ø147mm
483582*	30W	2.779lm	<b>3</b> 3.000K	<b>Gr</b>	Gris	Ø170 x 98mm	Ø147mm
483599*	30W	2.856lm	<b>4</b> 4.000K	<b>Gr</b>	Gris	Ø170 x 98mm	Ø147mm

\*Hasta fin de existencias/\* Until end of stock/\* Jusqu'à épuisement des stocks/\* Enquanto os estoques durarem

	Hz	φ							
220-240V ac	50-60Hz	> 0,5	CI	IP20	25°	>80	(L70B50>) 25.000h	24°	PC

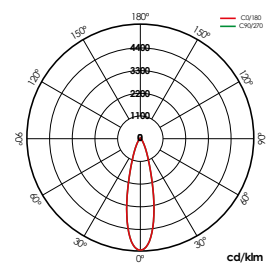

20W



# Navi

**Hasta 5 años de garantía**  
**Up to 5 years of warranty**  
**Jusqu'à 5 ans de garantie**  
**Alé 5 anos de garantia**

Soluciones  
 Solutions  
 Des solutions  
 Soluções

Pack BLUETOOTH  
 Pág.38

 Necesita driver DALI  
 You need DALI driver  
 Vous avez besoin d'un driver DALI  
 Você precisa da driver DALI



Ñ/ NAVI REGULABLE de serie:  
 Apto para regulador convencional de incandescencia/TRIAC. Cabezal basculante.  
 E/ DIMMABLE NAVI serial:  
 Suitable for conventional incandescent regulator/TRIAC. Tilt head.  
 F/ NAVI DIMMABLE en série: Suitable for conventional incandescent regulator/TRIAC. Tête pivotante.  
 P/ NAVI REGULÁVEL de Série: Apropriado para regulador incandescente convencional/TRIAC. Orientável.

Barcode	W <sub>T</sub>	⚡	φ <sub>T</sub>	K	⊙	⊙	⊙	
171021	6,5W	230V ac	528lm	3	3.000K	Bl	Blanco	SI
171038	6,5W	230V ac	554lm	4	4.000K	Bl	Blanco	SI
412285	6,5W	230V ac	528lm	3	3.000K	Gr	RAL 9006	SI
412292	6,5W	230V ac	554lm	4	4.000K	Gr	RAL 9006	SI
171007	6,5W	100-240V ac	528lm	3	3.000K	Bl	Blanco	NO
171014	6,5W	100-240V ac	554lm	4	4.000K	Bl	Blanco	NO
412261	6,5W	100-240V ac	528lm	3	3.000K	Gr	RAL 9006	NO
412278	6,5W	100-240V ac	554lm	4	4.000K	Gr	RAL 9006	NO

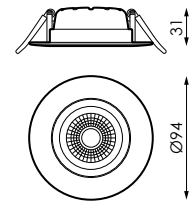

Hz	□	⊙	⊙	∠	⊙	⊙	↻	⊙	⊙	
50-60Hz	CII	IP20	-10°C ~ +45°C	45°	>80	(L70B50>)	50.000h	25°	AL	Ø75-80mm

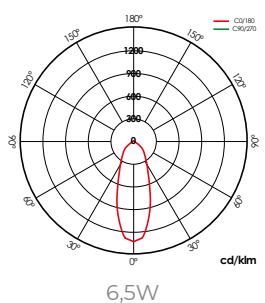

BAJO PEDIDO / ON REQUEST / SUR COMMANDE / A PEDIDO

  **Kit de emergencia 1h**  
 Emergency kit 1h  
 Kit d'urgence 1h  
 Kit de emergência 1h

# Nahe CL

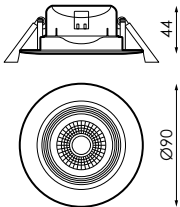

Barcode	W <sub>T</sub>	φ		K		∞
545488*	6,5W	542lm	<b>3</b>	3.000K	<b>Bl</b>	Blanco
545495*	6,5W	573lm	<b>4</b>	4.000K	<b>Bl</b>	Blanco
545501*	6,5W	542lm	<b>3</b>	3.000K	<b>Gr</b>	RAL 9006
545518*	6,5W	573lm	<b>4</b>	4.000K	<b>Gr</b>	RAL 9006

\*Hasta fin de existencias/\* Until end of stock/\* Jusqu'à épuisement des stocks/\* Enquanto os estoques durarem

⚡	Hz	□	⊙	△	⌂	⌚	↻	📄	🔧
220-240V ac	50-60Hz	CII	IP20	35°	>80	(L70B50->) 15.000h	25°	PC	Ø74mm

# Nahe SQ

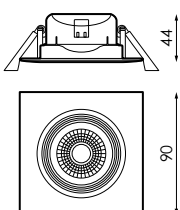

Barcode	W <sub>T</sub>	φ		K		∞
545525*	6,5W	542lm	<b>3</b>	3.000K	<b>Bl</b>	Blanco
545532*	6,5W	573lm	<b>4</b>	4.000K	<b>Bl</b>	Blanco
545549*	6,5W	542lm	<b>3</b>	3.000K	<b>Gr</b>	RAL 9006
545556*	6,5W	573lm	<b>4</b>	4.000K	<b>Gr</b>	RAL 9006

\*Hasta fin de existencias/\* Until end of stock/\* Jusqu'à épuisement des stocks/\* Enquanto os estoques durarem

⚡	Hz	□	⊙	△	⌂	⌚	↻	📄	🔧
220-240V ac	50-60Hz	CII	IP20	35°	>80	(L70B50->) 15.000h	25°	PC	Ø74mm

# Nahe CL



**Ñ/ NAHE REGULABLE** de serie:  
 Apto para regulador convencional de incandescencia/TRIAC. Cabezal basculante.  
**E/ DIMMABLE NAHE** serial:  
 Suitable for conventional incandescent regulator/TRIAC. Tilt head. **F/ NAHE DIMMABLE** en série: Suitable for conventional incandescent regulator/TRIAC. Tête pivotante. **P/ NAHE REGULÁVEL** de Série: Apropriado para regulador incandescente convencional/TRIAC. Orientável.



	W <sub>T</sub>	φ	K			
587563	7W	677lm	<b>3</b> 3.000K	<b>Bl</b> Blanco	SI	
587570	7W	739lm	<b>4</b> 4.000K	<b>Bl</b> Blanco	SI	
587587	7W	677lm	<b>3</b> 3.000K	<b>Gr</b> RAL 9006	SI	
587594	7W	739lm	<b>4</b> 4.000K	<b>Gr</b> RAL 9006	SI	
580229	7W	677lm	<b>3</b> 3.000K	<b>Bl</b> Blanco	NO	
580236	7W	739lm	<b>4</b> 4.000K	<b>Bl</b> Blanco	NO	
580243	7W	677lm	<b>3</b> 3.000K	<b>Gr</b> RAL 9006	NO	
580250	7W	739lm	<b>4</b> 4.000K	<b>Gr</b> RAL 9006	NO	

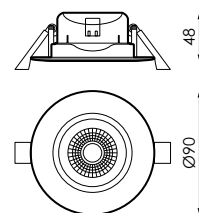

					>80 CRI icon"/>				
220-240V ac	50-60Hz	CII	IP20	38°	>80	(L70B50>)25.000h	25°	PC	Ø70mm



# Nahe SQ

Ñ/ NAHE REGULABLE de serie:  
Apto para regulador convencional de incandescencia/TRIAC. Cabezal basculante.  
E/ DIMMABLE NAHE serial:  
Suitable for conventional incandescent regulator/TRIAC. Tilt head.  
F/ NAHE DIMMABLE en série: Suitable for conventional incandescent regulator/TRIAC. Tête pivotante.  
P/ NAHE REGULÁVEL de Série: Apropriado para regulador incandescente convencional/TRIAC. Orientável.

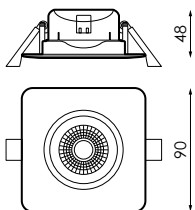

Barcode	W <sub>t</sub>	Φ <sub>t</sub>	K	Color	Finish	Beam
587600	7W	677lm	3	3.000K	Bl	SI
587617	7W	739lm	4	4.000K	Bl	SI
587624	7W	677lm	3	3.000K	Gr	SI
587631	7W	739lm	4	4.000K	Gr	SI
580267	7W	677lm	3	3.000K	Bl	NO
580274	7W	739lm	4	4.000K	Bl	NO
580281	7W	677lm	3	3.000K	Gr	NO
580298	7W	739lm	4	4.000K	Gr	NO

220-240V ac	50-60Hz	CII	IP20	38°	>80	(L70B50>) 25.000h	25°	PC	70 x 70mm

[GRÁFICOS: Unidades en mm/GRÁFICOS: Units in mm/GRAPHIQUES: Unités en mm/GRÁFICOS: Unidades em mm]

# DL 306

<i>icon basic</i>	<i>icon Evo smart</i>	<b>Recomendación</b> Recommendation Recommandation Recomendação



	$W_T$						
958103*	máx. 1x50W	IP20	GU10/GU5.3	<b>Bl</b> Blanco	AL		Ø75mm
958097*	máx. 1x50W	IP20	GU10/GU5.3	<b>Gr</b> Niquel	AL		Ø75mm

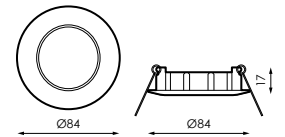

\*Hasta fin de existencias/\* Until end of stock/\* Jusqu'à épuisement des stocks/\* Enquanto os estoques durarem

## AVISO / WARNING / AVERTISSEMENT / AVISO

Ñ/ Casquillo NO incluido.

E/ Cap NOT included.

F/ Culot NON inclus.

P/ Base NÃO incluído.

# DL 325

<i>icon basic</i>	<i>icon Evo smart</i>	<b>Recomendación</b> Recommendation Recommandation Recomendação



	$W_T$						
025294*	máx. 1x50W	IP20	GU10/GU5.3	<b>Bl</b> Blanco	Z		Ø64mm
025331*	máx. 1x50W	IP20	GU10/GU5.3	<b>Gr</b> Niquel	Z		Ø64mm

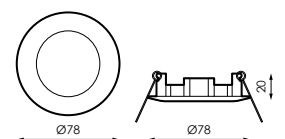

\*Hasta fin de existencias/\* Until end of stock/\* Jusqu'à épuisement des stocks/\* Enquanto os estoques durarem

## AVISO / WARNING / AVERTISSEMENT / AVISO

Ñ/ Casquillo NO incluido.

E/ Cap NOT included.

F/ Culot NON inclus.

P/ Base NÃO incluído.







# Accesorios

Accessories

Accessoires

Acessórios

	Viessa		Kentau CL				Kentau SQ				Breno II PC	Breno CL basic		
	36W	50W	6W	9W	14W	20W	6W	9W	14W	20W		6W	12W	18W
	532181					•				•				
	532198				•				•					
	532204				•			•						
	532211			•				•						
	543118						•				•			
	543125					•			•					
	387545			•										
	387552			•										
	387569					•								
	387576					•								
	387583						•							
	387590						•							
	387606							•						
	387613							•						
	387620								•					
	387637								•					
	387644									•				
	387651									•				
	495868	•												
	495875	•												
	495882	•												
	495912		•											
	495929		•											
	495936		•											
	553667										•			
	553674										•			
	590563											•		
	590570												•	
590587													•	



553667

Accesorio superficie blanco  
Accessory surface white  
Surface de l'accessoire blanche  
Superfície acessória branca



553674

Accesorio superficie RAL 9006  
Accessory surface RAL 9006  
Surface de l'accessoire RAL 9006  
Superfície acessória RAL 9006



495868

Aro decorativo Blanco 36W  
Decorative ring White 36W  
Cerceau décoratif Blanc 36W  
Arco decorativo Branco 36W



495875

Aro decorativo Negro 36W  
Decorative ring Black 36W  
Cerceau décoratif Noir 36W  
Arco decorativo Preto 36W



495882

Aro decorativo Madera 36W  
Decorative ring Wood 36W  
Cerceau décoratif Bois 36W  
Arco decorativo Madeira 36W

495912

Aro decorativo Blanco 50W  
Decorative ring White 50W  
Cerceau décoratif Blanc 50W  
Arco decorativo Branco 50W

495929

Aro decorativo Negro 50W  
Decorative ring Black 50W  
Cerceau décoratif Noir 50W  
Arco decorativo Preto 50W

495936

Aro decorativo Madera 50W  
Decorative ring Wood 50W  
Cerceau décoratif Bois 50W  
Arco decorativo Madeira 50W

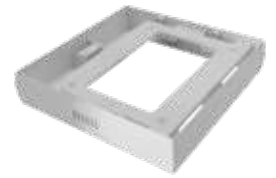
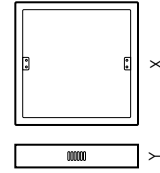
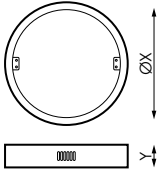

Accesorio superficie  
Accessory surface  
Surface accessoire  
Superfície acessória

Accesorio superficie  
Accessory surface  
Surface accessoire  
Superfície acessória

	W <sub>T</sub>	⊙	↔↕
387590	20W	Gr	Ral 9006 Ø228 x 35mm
387583	20W	Bl	Blanco Ø228 x 35mm
387576	14W	Gr	Ral 9006 Ø178 x 35mm
387569	14W	Bl	Blanco Ø178 x 35mm
387552	9W	Gr	Ral 9006 Ø153 x 35mm
387545	9W	Bl	Blanco Ø153 x 35mm

	W <sub>T</sub>	⊙	↔↕
387651	20W	Gr	Ral 9006 230 x 230 x 35mm
387644	20W	Bl	Blanco 230 x 230 x 35mm
387637	14W	Gr	Ral 9006 180 x 180 x 35mm
387620	14W	Bl	Blanco 180 x 180 x 35mm
387613	9W	Gr	Ral 9006 155 x 155 x 35mm
387606	9W	Bl	Blanco 155 x 155 x 35mm



Driver con regulación  
Driver with dimming  
Driver avec régulation  
Driver com regulamento

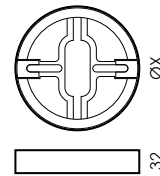

	W <sub>T</sub>	⊙
N 507325	20W	
N 507332	14W	
543125*	14W	CTOUCH
532181	20W	1-10V
532198	14W	1-10V
532204	9W	1-10V
532211	6W	1-10V

Accesorio superficie  
Accessory surface  
Surface accessoire  
Superfície acessória

	W <sub>T</sub>	⊙	↔↕
N 590587	20W	Bl	Blanco Ø228 x 35mm
N 590570	14W	Bl	Blanco Ø178 x 35mm
N 590563	9W	Bl	Blanco Ø153 x 35mm

\*Hasta fin de existencias/\* Until end of stock/\* Jusqu'à épuisement des stocks/\* Enquanto os estoques durarem





# Pantallas

Screens  
Des écrans  
Screens

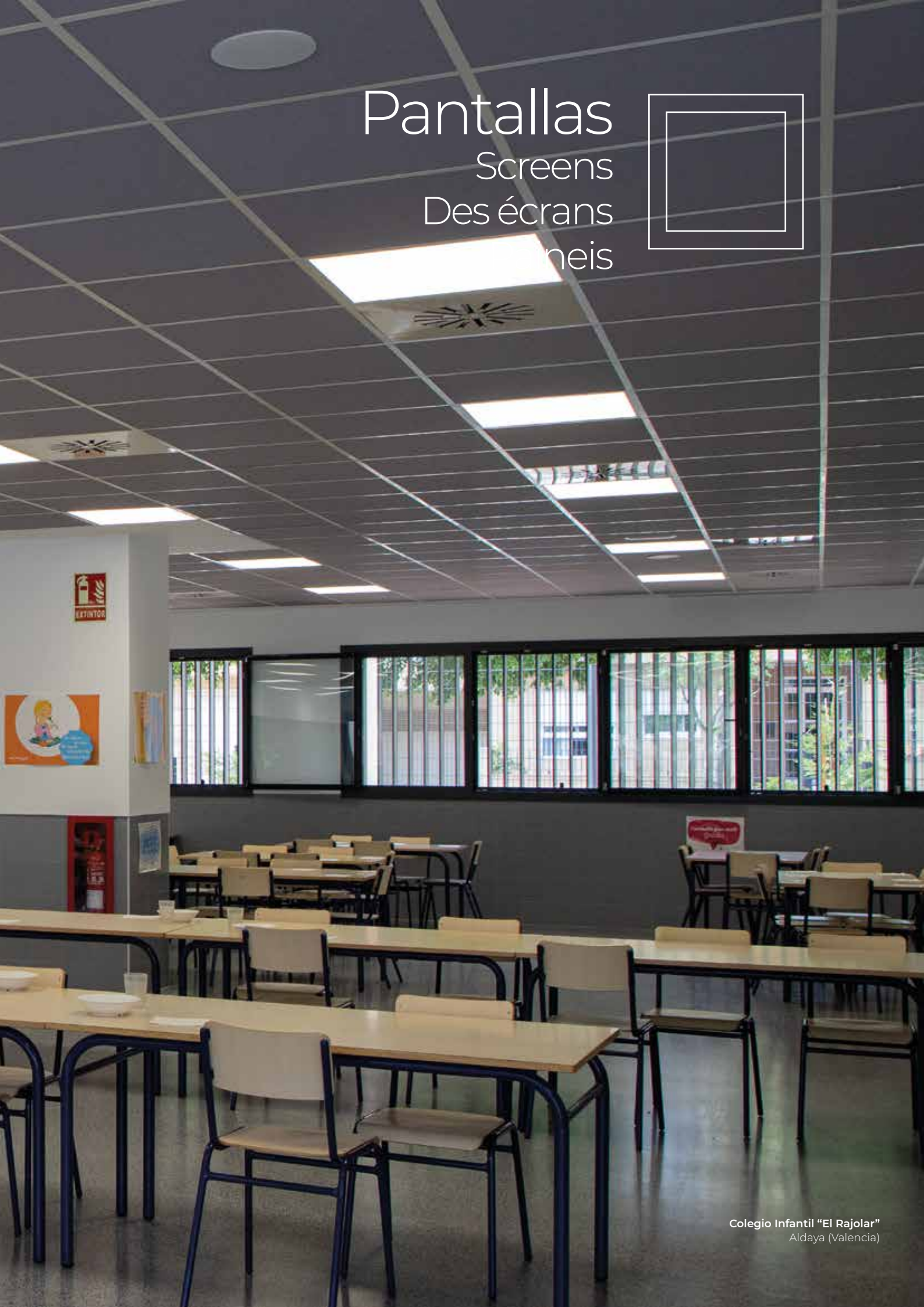

# Rhoda

 **Hasta 5 años de garantía**  
**Up to 5 years of warranty**  
**Jusqu'à 5 ans de garantie**  
**Alé 5 anos de garantia**

Soluciones  
 Solutions  
 Des solutions  
 Soluções





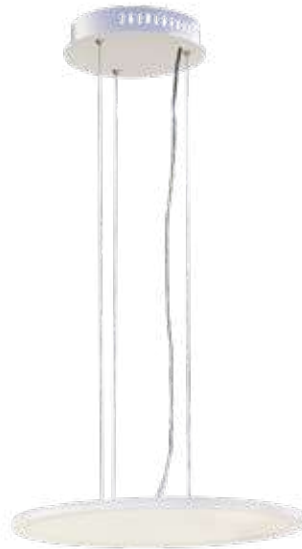





Pack BLUETOOTH  
 Pág.38

 Necesita driver DALI  
 You need DALI driver  
 Vous avez besoin d'un driver DALI  
 Você precisa da driver DALI



	$W_{LED}$	$W_T$	$\phi_{LED}$	$\phi_T$	K	$\leftrightarrow$
552349*	32W	35W	3.454lm	2.831lm	<b>3</b>	3.000K Ø400 x 850mm
552356*	32W	35W	3.578lm	2.947lm	<b>4</b>	4.000K Ø400 x 850mm
552363*	32W	35W	3.507lm	2.911lm	<b>3</b>	3.000K Ø600 x 850mm
552370*	32W	35W	3.612lm	3.041lm	<b>4</b>	4.000K Ø600 x 850mm

\*Hasta fin de existencias/\* Until end of stock/\* Jusqu'à épuisement des stocks/\* Enquanto os estoques durarem

	Hz										
230V ac	50Hz	CII	IP20	-5°C~+40°C	120°	>80	(L70B50) 40,000h	BL	FE	PO	SUSPENDIDO

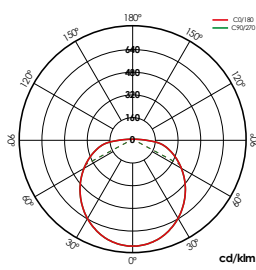
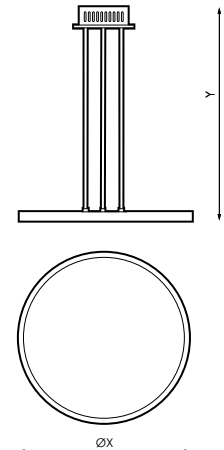

35W

BAJO PEDIDO / ON REQUEST / SUR COMMANDE / A PEDIDO





Hasta 5 años de garantía  
Up to 5 years of warranty  
Jusqu'à 5 ans de garantie  
Alé 5 anos de garantia

# Diane Superficie



## Diane Superficie

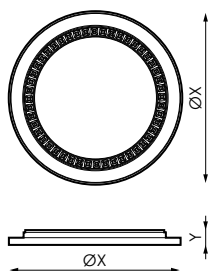

	W <sub>LED</sub>	W <sub>T</sub>	φ <sub>LED</sub>	φ <sub>T</sub>	K	↕	
446471*	10W	12W	1.616lm	1.389lm	<b>4</b>	4.000K	Ø250 x 33mm
446488*	10W	12W	1.397lm	1.215lm	<b>3</b>	3.000K	Ø250 x 33mm
446495*	22W	25W	3.523lm	2.998lm	<b>4</b>	4.000K	Ø400 x 33mm
446501*	22W	25W	3.362lm	2.783lm	<b>3</b>	3.000K	Ø400 x 33mm

\*Hasta fin de existencias/\* Until end of stock/\* Jusqu'à épuisement des stocks/\* Enquanto os estoques durarem

## Diane SQ Superficie

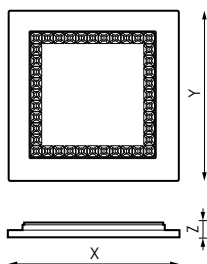

	W <sub>LED</sub>	W <sub>T</sub>	φ <sub>LED</sub>	φ <sub>T</sub>	K	↕	
446518*	10W	12W	1.663lm	1.464lm	<b>4</b>	4.000K	250 x 250 x 33mm
446525*	10W	12W	1.564lm	1.376lm	<b>3</b>	3.000K	250 x 250 x 33mm
446532*	22W	25W	3.216lm	2.852lm	<b>4</b>	4.000K	400 x 400 x 33mm
446549*	22W	25W	3.035lm	2.674lm	<b>3</b>	3.000K	400 x 400 x 33mm

\*Hasta fin de existencias/\* Until end of stock/\* Jusqu'à épuisement des stocks/\* Enquanto os estoques durarem

	Hz										
230V ac	50-60Hz	CII	IP20	-5°C~+35°C	90°	>80	UGR <19	(L70B50>) 50,000h	BL	PC	SUPERFICIE

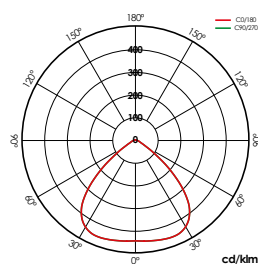

4.000K

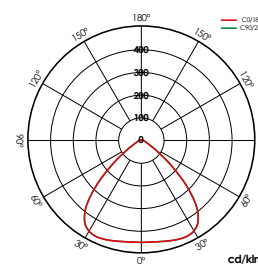

SQ 4.000K

[GRÁFICOS: Unidades en mm/ GRAPPHICS: Units in mm/ GRAPHICS: Units in mm/ GRÁFICOS: Unidades em mm]



# Diane Tech Switch

## Empotrar

N  
NEW



Hasta 5 años de garantía  
Up to 5 years of warranty  
Jusqu'à 5 ans de garantie  
Alé 5 anos de garantia



Con selector de t° de color a través de interruptor  
With t° color selector through switch  
Avec sélecteur t° de couleur par commutateur  
Com o seletor de cores através da chave

Soluciones  
Solutions  
Des solutions  
Soluções

Pack BLUETOOTH  
Pág.38

Pack CTE  
Pág.30

Pack Aulas  
Pág.34



Necesita driver DALI  
You need DALI driver  
Vous avez besoin d'un driver DALI  
Você precisa da driver DALI



	Hz											
230V ac	50-60Hz	CII	IP20	-5°C~+35 °C	90°	>80	UGR <19	(L70B50>) 50.000h	BL	AL	PC	EMPOTRAR

BAJO PEDIDO / ON REQUEST / SUR COMMANDE / A PEDIDO



Bluetooth®



**Kit de emergencia 1h**

Emergency kit 1h

Kit d'urgence 1h

Kit de emergência 1h

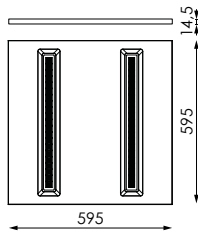

## Diane Tech Switch Empotrar 60x60

	$W_{LED}$	$W_T$		$\phi_{LED}$	$\phi_T$	K		
496360	32W	35W	850mA	4.678m	3.725lm	<b>3</b> 3.000K		595 x 595 x 14,5mm
				4.986lm	4.164lm	<b>4</b> 4.000K		575 x 575mm

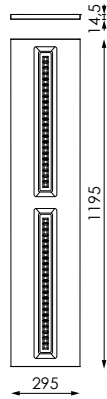

## Diane Tech Switch Empotrar 120x30

	$W_{LED}$	$W_T$		$\phi_{LED}$	$\phi_T$	K		
<b>N</b> 496377	32W	35W	850mA	4.678m	3.725lm	<b>3</b> 3.000K		1195 x 295 x 14,5mm
				4.986lm	4.164lm	<b>4</b> 4.000K		1175 x 275mm

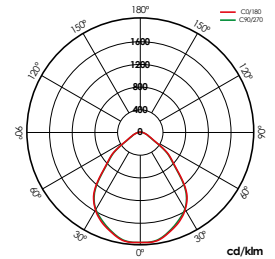

### ACCESORIOS / ACCESSOIRES / ACCESSORIES / ACESSÓRIOS + INFO PAG.162



491532 INC. 4ud

Kit suspensión 1,5m



964562

Marco empotrar techo escayola  
600 x 600mm



164092

Cajón superficie 600 x 600mm



207591

Marco empotrar techo escayola  
1.200 x 300mm



207874

Cajón superficie 1.200 x 300mm

### MONTAJE / MOUNTING / MONTAGE / MONTAGEM

Ñ/ Unidades necesarias para el montaje de la luminaria.

E/ Units needed for the assembly of the luminaire.

F/ Unités nécessaires pour l'assemblage du luminaire.

P/ Unidades necessárias para a montagem da luminária.

Cod/	Suspensión
491532	1ud

# Diane Tech WAS

Empotrar

N  
NEW

Hasta 5 años de garantía  
Up to 5 years of warranty  
Jusqu'à 5 ans de garantie  
Alé 5 anos de garantia

Soluciones  
Solutions  
Des solutions  
Soluções

Pack BLUETOOTH  
Pág.38

Pack CTE  
Pág.30

Pack Aulas  
Pág.34



	$W_{LED}$	$W_T$		$\phi_{LED}$	$\phi_T$	K			
581264	32W	35W	850mA	4.678~4.986lm	3.725~4.164lm		3.000K~4.000K	595 x 595 x 14,5mm	DALI
	Hz								
230V ac	50-60Hz	CII	IP20	-5°C~+35°C	90°	>80	UGR <19	(L70B50>) 50.000h	BL AL PC EMPOTRAR 575 x 575mm

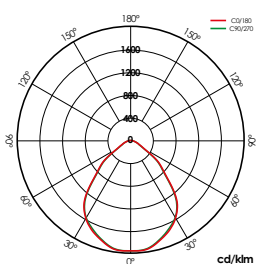
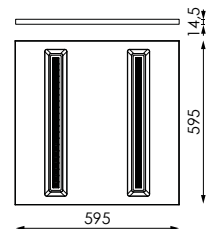

595x595mm

[GRÁFICOS: Unidades en mm/ GRAPHICS: Units in mm/ GRAPHIQUES: Unités en mm/ GRÁFICOS: Unidades em mm]



BAJO PEDIDO / ON REQUEST / SUR COMMANDE / A PEDIDO



**Bluetooth®**



**Kit de emergencia 1h**  
Emergency kit 1h  
Kit d'urgence 1h  
Kit de emergência 1h

ACCESORIOS / ACCESSOIRES / ACCESSORIES / ACESSÓRIOS

+ INFO PAG. 162



491532 INC. 4ud

Kit suspensión 1,5m



964562

Marco empotrar techo escayola  
600 x 600mm



164092

Cajón superficie 600 x 600mm

MONTAJE / MOUNTING / MONTAGE / MONTAGEM

Ñ/ Unidades necesarias para el montaje de la luminaria.

E/ Units needed for the assembly of the luminaire.

F/ Unités nécessaires pour l'assemblage du luminaire.

P/ Unidades necessárias para a montagem da luminária.



Cod/

491532



Suspensión  
Suspension

1ud

# Silent I

## UGR



Hasta 5 años de garantía  
Up to 5 years of warranty  
Jusqu'à 5 ans de garantie  
Alé 5 anos de garantia



Soluciones Solutions Des solutions Soluções
Pack BLUETOOTH Pág.38
Pack CTE Pág.30
Pack Aulas Pág.34
Necesita driver DALI You need DALI driver Vous avez besoin d'un driver DALI Você precisa da driver DALI

- Ñ/ \*UGR <19 con R(%):70/50/20, S(m2)<30 y h(m)>3,15.
- E/ \*UGR <19 with R(%):70/50/20, S(m2)<30 and h(m)>3,15.
- F/ \*UGR <19 avec R(%):70/50/20, S(m2)<30 et h(m)>3,15.
- P/ \*UGR <19 com R(%):70/50/20, S(m2)<30 e h(m)>3,15.



	W <sub>LED</sub>	W <sub>T</sub>		Φ	Φ <sub>LED</sub>	Φ <sub>T</sub>	K				
470766	36W	40W	1.000mA	>0,9 >80	4.953lm	4.026lm	4	4.000K	600 x 600mm	575 x 575mm	DALI
470759	36W	40W	1.000mA	>0,9 >80	4.316lm	3.618lm	3	3.000K	600 x 600mm	575 x 575mm	NO
470742	36W	40W	1.000mA	>0,9 >80	4.953lm	4.026lm	4	4.000K	600 x 600mm	575 x 575mm	NO
N 561167	36W	40W	1.000mA	>0,9 >80	5.123lm	4.169lm	6,5	6.500K	600 x 600mm	575 x 575mm	NO
N 587365	36W	40W	1.000mA	>0,9 >90	4.914lm	3.820lm	4	4.000K	600 x 600mm	575 x 575mm	NO

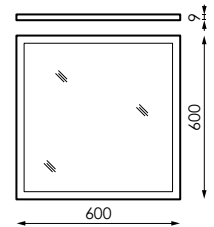

	W <sub>LED</sub>	W <sub>T</sub>		Φ	Φ <sub>LED</sub>	Φ <sub>T</sub>	K				
483933	36W	40W	1.000mA	>80	4.953lm	4.026lm	4	4.000K	300 x 1.200mm	275 x 1.175mm	DALI
478052	36W	40W	1.000mA	>80	4.316lm	3.618lm	3	3.000K	300 x 1.200mm	275 x 1.175mm	NO
478069	36W	40W	1.000mA	>80	4.953lm	4.026lm	4	4.000K	300 x 1.200mm	275 x 1.175mm	NO
483957	56W	60W	1.500mA	>80	7.517lm	6.089lm	4	4.000K	600 x 1.200mm	575 x 1.175mm	NO

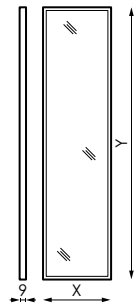

	Hz										
230V ac	50-60Hz	CII	IP20	IP40	UGR <19**	(L70B50>)	50.000h	BL	FE	PMMA P	EMPOTRAR

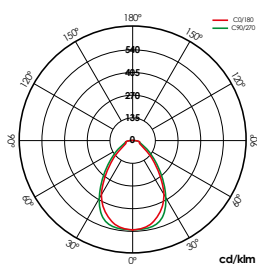

4.000K/595x595mm

[GRÁFICOS: Unidades en mm/ GRAPHICS: Units in mm/ GRAPHIQUES: Unités en mm/ GRÁFICOS: Unidades em mm]

BAJO PEDIDO / ON REQUEST / SUR COMMANDE / A PEDIDO



Bluetooth



**Kit de emergencia 1h**

Emergency kit 1h

Kit d'urgence 1h

Kit de emergência 1h

ACCESORIOS / ACCESSOIRES / ACCESSORIES / ACESSÓRIOS

+ INFO PAG.162



207638 INC. 1ud

Alimentación 3x0,75mm<sup>2</sup>



537933 INC. 1ud

Alimentación 5x0,75mm<sup>2</sup>



472500 INC. 4ud

Kit cable suspensión 1,5m.



397391

Marco empotrar techo perfil oculto 600 x 600mm  
Comprobar compatibilidad con el perfil oculto



164092

Cajón superficie 600 x 600mm



207874

Cajón superficie 1.200 x 300mm



383806

Cajón superficie 1.200 x 600mm



484039\*

Cajón superficie desmontable 300 x 1200 x 48mm

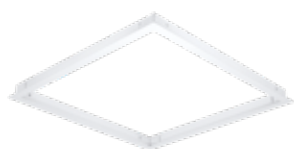

964562

Marco empotrar techo escayola 600 x 600mm



207591

Marco empotrar techo escayola 1.200 x 300mm



384070

Marco empotrar techo escayola 1.200 x 600mm



484008\*

Marco empotrar desmontable 300 x 1200mm

MONTAJE / MOUNTING / MONTAGE / MONTAGEM

Ñ/ Unidades necesarias para el montaje de la luminaria.

E/ Units needed for the assembly of the luminaire.

F/ Unités nécessaires pour l'assemblage du luminaire.

P/ Unidades necessárias para a montagem da luminária.

Cod/	Suspensión Suspension	Alimentación Power
207638	-	1ud
537933	-	1ud
472500	1ud	-

\*Hasta fin de existencias/\* Until end of stock/\* Jusqu'à épuisement des stocks/\* Enquanto os estoques durarem



# Etna

## Basic

**N**  
NEW

Soluciones  
Solutions  
Des solutions  
Soluções

Pack CTE  
Pág.30

Pack Aulas  
Pág.34



Necesita driver DALI  
You need DALI driver  
Vous avez besoin d'un driver DALI  
Você precisa da driver DALI



	Hz										
230V ac	50-60Hz	CII	IP20	IP44	120°	>80	(L70B50>) 30.000h	BL	FE	PS	EMPOTRAR



Centro del Ocio  
San Pedro del Pinatar (Murcia)

[GRÁFICOS: Unidades en mm/ GRAPHICS: Units in mm/ GRAPHIQUES: Unités en mm/ GRÁFICOS: Unidades em mm]

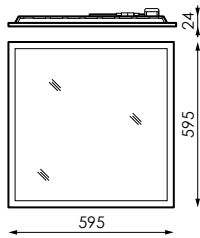

		$W_{LED}$	$W_T$		$\phi_{LED}$	$\phi_T$	K			
582087		32W	36W	1.000mA	5.238lm	3.691lm	<b>3</b>	3.000K	595 x 595 x 20mm	575 x 575mm
582070		32W	36W	1.000mA	5.305lm	4.156m	<b>4</b>	4.000K	595 x 595 x 20mm	575 x 575mm
582094		32W	36W	1.000mA	5.271lm	3.968lm	<b>6.5</b>	6.500K	595 x 595 x 20mm	575 x 575mm

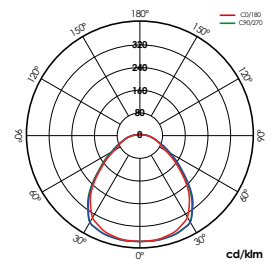

4.000K

BAJO PEDIDO / ON REQUEST / SUR COMMANDE / A PEDIDO



**Bluetooth®**



**Kit de emergencia 1h**

Emergency kit 1h

Kit d'urgence 1h

Kit de emergência 1h

ACCESORIOS / ACCESSOIRES / ACCESSORIES / ACESSÓRIOS

+ INFO PAG.162



397391

Marco empotrar techo perfil oculto 600 x 600mm  
Comprobar compatibilidad con el perfil oculto

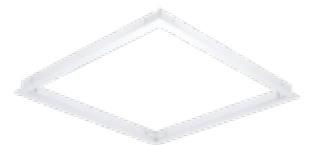

964562

Marco empotrar techo escayola 600 x 600mm

# Etna Slim



Soluciones  
Solutions  
Des solutions  
Soluções

Pack CTE  
Pág.30

Pack Aulas  
Pág.34



Necesita driver DALI  
You need DALI driver  
Vous avez besoin d'un driver DALI  
Você precisa da driver DALI



	Hz										
230V ac	50-60Hz	CII	IP20	IP40	120°	>80	(L70B50-) 50.000h	BL	FE	PMMA	EMPOTRAR



Fitness Centro Deportivo  
Valmojado

[GRÁFICOS: Unidades en mm/ GRAPHICS: Units in mm/ GRAPHIQUES: Unités en mm/ GRÁFICOS: Unidades em mm]

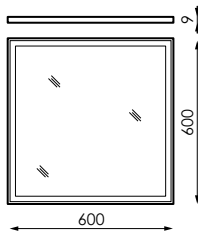

	$W_{LED}$	$W_T$		$\phi_{LED}$	$\phi_T$	K			
404693	40W	43W	1.000mA	4.583lm	3.664lm	<b>3</b>	3.000K	600 x 600mm	575 x 575mm
404471	40W	43W	1.000mA	4.813lm	3.898m	<b>4</b>	4.000K	600 x 600mm	575 x 575mm
404488	40W	43W	1.000mA	5.035lm	4.059lm	<b>6.5</b>	6.500K	600 x 600mm	575 x 575mm

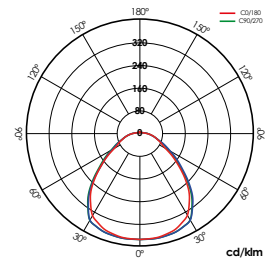

#### BAJO PEDIDO / ON REQUEST / SUR COMMANDE / A PEDIDO



**Bluetooth**



**Kit de emergencia 1h**

Emergency kit 1h

Kit d'urgence 1h

Kit de emergência 1h

#### ACCESORIOS / ACCESSOIRES / ACCESSORIES / ACESSÓRIOS

+ INFO PAG. 162



164092

Cajón superficie 600 x 600mm



397391

Marco empotrar techo perfil oculto 600 x 600mm  
Comprobar compatibilidad con el perfil oculto



964562

Marco empotrar techo escayola 600 x 600mm

**\*AVISO / \*WARNING / \*AVERTISSEMENT / \*AVISO**

Ñ/ Certificación ENEC y 50.000h a partir de abril.

E/ ENEC certification and 50,000h from april.

F/ Certification ENEC et 50 000h à partir d'avril.





P/ Certificação ENEC e 50.000h a partir de abril.

# Accesorios

Accessories

Accessoires

Accessórios

		Diane Tech Switch empotrar 60x60	Diane Tech Switch empotrar 120x30	Diane Tech WAS 60x60	Silent I UGR 60x60	Silent I UGR 120x30	Silent I UGR 120x60	Etan Basic	Etna Slim
	207638				•	•	•		
	537933				•	•	•		
	207621								
	446570								
	472500				•	•	•		
	491532	•	•	•					
	164092	•			•			•	•
	207874		•			•			
	383806						•		
	484039					•			
	207591		•			•			
	384070						•		
	397391				•			•	•
	484008				•	•		•	•
	964562	•			•			•	•

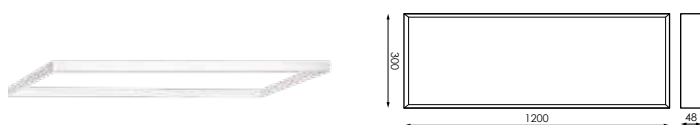

484039\*

Cajón montaje en superficie desmontable 1.200 x 300 x 48mm  
Removable surface mount box 1.200 x 300 x 48mm  
Box amovible à montage en surface 1.200 x 300 x 48mm  
Box de montagem em superfície removível 1.200 x 300 x 48mm



164092

Cajón montaje en superficie 600 x 600 x 60mm  
Box surface mounting 600 x 600 x 60mm  
Box montage en surface 600 x 600 x 60mm  
Box montagem em superfície 600 x 600 x 60mm

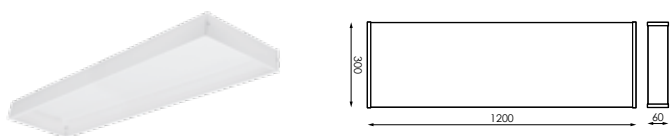

207874

Cajón montaje en superficie 1.200 x 300 x 60mm  
Box surface mounting 1.200 x 300 x 60mm  
Box montage en surface 1.200 x 300 x 60mm  
Box montagem em superfície 1.200 x 300 x 60mm

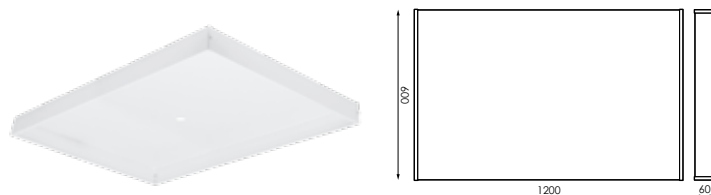

383806

Cajón montaje en superficie 1.200 x 600 x 60mm  
Box surface mounting 1.200 x 600 x 60mm  
Box montage en surface 1.200 x 600 x 60mm  
Box montagem em superfície 1.200 x 600 x 60mm

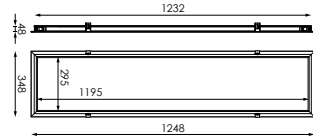

484008\*

Marco empotrar desmontable 1.248 x 348 x 48mm  
Removable frame recessed 1.248 x 348 x 48mm  
Cadre encastré détachable 1.248 x 348 x 48mm  
Quadro embutido removível 1.248 x 348 x 48mm

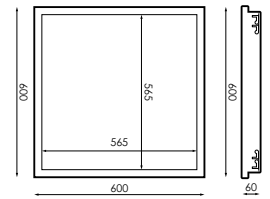

397391

Marco empotrar techo perfil oculto para modelo 600 x 600mm  
Frame recessed flush ceiling frame for model 600 x 600mm  
Marco encastré au plafond pour modèle 600 x 600mm  
Marco recesso teto do perfil oculto para o modelo 600 x 600mm

Dimensiones de hueco para techo de escayola 605 x 605mm  
Ceiling dimensions for plaster ceiling 605 x 605mm  
Cadre encastré plafond en plâtre 605 x 605mm  
Dimensiones creux plafond en plâtre 605 x 605mm  
Dimensões oco teto de gesso 605 x 605mm

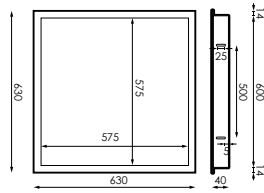

964562

Marco empotrar techo escayola (Espesor: 0,5-20mm) para modelo 600 x 600mm  
Frame recessed plaster ceiling (0,5-20mm thick) for model 600 x 600mm  
Cadre encastré plafond en plâtre (Épaisseur 0,5-20mm) modèle 600 x 600mm  
Marco recesso teto de gesso (Épaisseur 0,5-20mm) para modelo 600 x 600mm

Dimensiones de hueco para techo de escayola 605 x 605mm  
Ceiling dimensions for plaster ceiling 605 x 605mm  
Dimensiones creux plafond en plâtre 605 x 605mm  
Dimensões oco teto de gesso 605 x 605mm

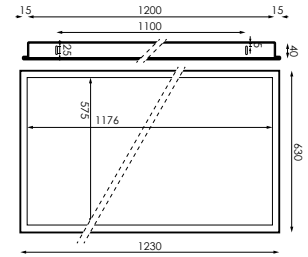

384070

Marco empotrar techo escayola (espesor 0,5-20mm) 1.200 x 600mm  
Frame recessed ceiling plaster (0,5-20mm thick) 1.200 x 600mm  
Cadre encastré plafond en plâtre (Épaisseur 0,5-20mm) 1.200 x 600mm  
Quadro rebaixado teto de gesso (Épaisseur 0,5-20mm) 1.200 x 600mm

Dimensiones de hueco para techo de escayola 605 x 605mm  
Ceiling dimensions for plaster ceiling 605 x 605mm  
Dimensiones creux plafond en plâtre 605 x 605mm  
Dimensões oco teto de gesso 605 x 605mm

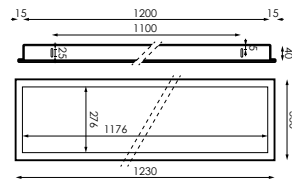

207591

Marco empotrar techo escayola (Espesor: 0,5-20mm) para modelo 1.200 x 300mm  
Frame inlay (Espesor: 0,5-20mm) plasterboard for model 1.200 x 300mm  
Cadre encastré plafond en plâtre (Épaisseur 0,5-20mm) 1.200 x 300mm  
Quadro rebaixado teto de gesso (Épaisseur 0,5-20mm) 1.200 x 300mm

Dimensiones de hueco para techo de escayola 1.205 x 305mm  
Ceiling dimensions for plaster ceiling 1.205 x 305mm  
Dimensiones creux plafond en plâtre 1.205 x 305mm  
Dimensões oco teto de gesso 1.205 x 305 milímetros



537933

INC. 1ud

Alimentación en cable transparente, 5x0,75mm<sup>2</sup> y largo de 1m  
Transparent power cable 5x0,75mm<sup>2</sup> and length of 1m  
Cordon d'alimentation transparent 5x0,75mm<sup>2</sup> et la longueur de 1m  
Cabo de alimentação transparente de 5x0,75mm<sup>2</sup> e comprimento de 1m

207638

INC. 1ud

Alimentación en cable transparente, 3x0,75mm<sup>2</sup> y largo de 1m  
Transparent power cable 3x0,75mm<sup>2</sup> and length of 1m  
Cordon d'alimentation transparent 3x0,75mm<sup>2</sup> et la longueur de 1m  
Cabo de alimentação transparente de 3x0,75mm<sup>2</sup> e comprimento de 1m



446570

INC. 2ud

Kit de suspensión con cables de acero, largo de 1,5m.  
Suspension kit with steel cable, length of 1,5m.  
Kit de suspension avec câble en acier, longueur de 1,5m.  
Kit de suspensão com cabo de aço, comprimento de 1,5m.

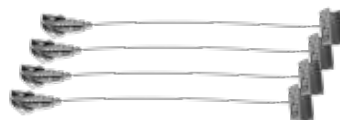

491532

INC. 4ud

Kit de suspensión con cables de acero, largo de 1,5m.  
Suspension kit with steel cable, length of 1,5m.  
Kit de suspension avec câble en acier, longueur de 1,5m.  
Kit de suspensão com cabo de aço, comprimento de 1,5m.



472500

INC. 4ud

Kit cable de seguridad 1,5m.  
Safety cable kit 1,5m.  
Kit de câbles de sécurité 1,5m.  
Kit de cabo de segurança 1,5m.



207621

INC. 1ud

Suspensión en cable de acero, Ø1,5mm y largo de 1m  
Steel cable suspension, Ø1,5mm and length of 1m  
Câble suspension en acier, Ø1,5mm et la longueur de 1m  
Suspensão cabo de aço, Ø1,5mm e comprimento de 1m

\*Hasta fin de existencias/\* Until end of stock/\* Jusqu'à épuisement des stocks/\* Enquanto os estoques durarem







Solar





# Draco

N  
NEW



**Sensor de Presencia y Luminosidad (PIR)**  
Presence and Brightness Sensor (PIR)  
Présence et Capteur de Lumière (PIR)  
Presença e sensor de luz (PIR)



**Solar**  
Solar  
Solaire  
Solar



CIII



IP65



>80



(L70B50-) 35.000h



PC



ABS



[GRÁFICOS: Unidades en mm/ GRÁFICOS: Units in mm/GRÁFICOS: Unités en mm/GRÁFICOS: Unidades em mm]

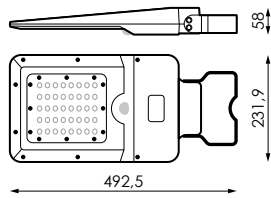

	$W_T$	$\phi_T$	K		
590624	15W	1.801lm	<b>3</b>	3.000K	Gr RAL 7010
590631	15W	1.916lm	<b>4</b>	4.000K	Gr RAL 7010

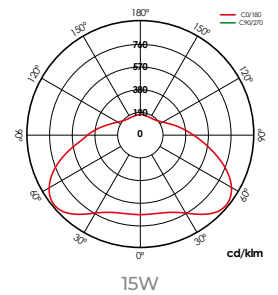

#### ACCESORIOS / ACCESSOIRES / ACCESSORIES / ACESSÓRIOS



590686

Accesorio montaje poste  
Ø40-60mm



590648

Accesorio montaje baculo  
Ø40-50mm

#### INFORMACIÓN / INFORMATION / INFORMATION / INFORMAÇÕES

Ñ/ Batería reemplazable

F/ Batterie remplaçable

E/ Replaceable battery

P/ Bateria substituível





**Sensor de Presencia y Luminosidad (PIR)**  
Presence and Brightness Sensor (PIR)  
Présence et Capteur de Lumière (PIR)  
Presença e sensor de luz (PIR)



**Solar**  
Solar  
Solaire  
Solar



Barcode	W <sub>T</sub>	φ		K	Gr	Color
590693	10W	1.047lm	3	3.000K	Gr	RAL 7010
590709	10W	1.114lm	4	4.000K	Gr	RAL 7010

Beam Spread	Protection	Color Temp	Life	Material	Finish
CIII	IP65	>80	(L70B50>) 25.000h	PC (Lente) ABS (Cuerpo)	AL

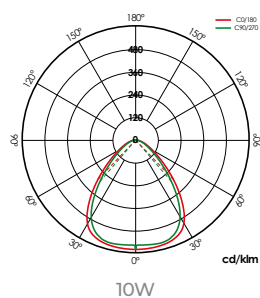
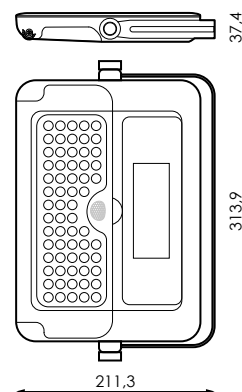

## INFORMACIÓN / INFORMATION / INFORMATION / INFORMAÇÕES



Ñ/ Batería reemplazable

F/ Batterie remplaçable

E/ Replaceable battery

P/ Bateria substituível

**Sensor de Presencia y Luminosidad (PIR)**  
Presence and Brightness Sensor (PIR)  
Présence et Capteur de Lumière (PIR)  
Presença e sensor de luz (PIR)



**Solar**  
Solar  
Solaire  
Solar

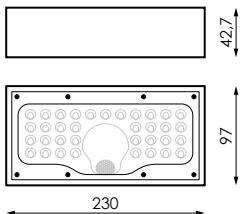
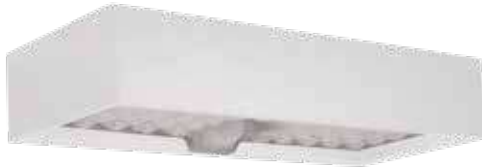

Barcode	W <sub>T</sub>	Φ		K	Color	Finish
590716	6W	748lm	3	3.000K	BI	RAL 9016
590723	6W	796lm	4	4.000K	BI	RAL 9016
590730	6W	748lm	3	3.000K	N	RAL 9005
590747	6W	796lm	4	4.000K	N	RAL 9005

III	IP65	>80	(L70B50>) 25.000h	PC	ABS
-----	------	-----	-------------------	----	-----

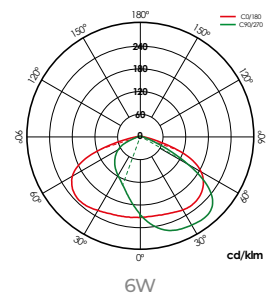

INFORMACIÓN / INFORMATION / INFORMAÇÕES

Ñ/ Batería reemplazable

F/ Batterie remplaçable

E/ Replaceable battery

P/ Bateria substituível





# Summet



**Sensor de Presencia y Luminosidad (PIR)**  
 Presence and Brightness Sensor (PIR)  
 Présence et Capteur de Lumière (PIR)  
 Presença e sensor de luz (PIR)



**Solar**  
 Solar  
 Solaire  
 Solar



1,5W



3,2W



6,8W



CIII



IP65



90°



>80



PC-T



ABS



[GRÁFICOS: Unidades en mm/ GRÁFICOS: Units in mm/GRAPHIQUES: Unités en mm/GRÁFICOS: Unidades em mm]

## Summet 1,5W

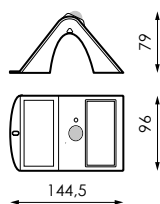

▮	W <sub>T</sub>	φ <sub>T</sub>	K	⏏	⊗
472098	1,5W	200lm	<b>3</b>	3.000K (L70B50>) 15.000h	<b>Bl</b> Blanco
472104	1,5W	220lm	<b>4</b>	4.000K (L70B50>) 15.000h	<b>Bl</b> Blanco
472074	1,5W	200lm	<b>3</b>	3.000K (L70B50>) 15.000h	<b>N</b> Negro
472081	1,5W	220lm	<b>4</b>	4.000K (L70B50>) 15.000h	<b>N</b> Negro
472111*	1,5W	200lm	<b>3</b>	3.000K (L70B50>) 15.000h	<b>Gr</b> Gris
472128	1,5W	220lm	<b>4</b>	4.000K (L70B50>) 15.000h	<b>Gr</b> Gris

## Summet 3,2W

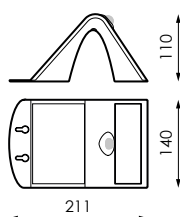

▮	W <sub>T</sub>	φ <sub>T</sub>	K	⏏	⊗
472159	3,2W	380lm	<b>3</b>	3.000K (L70B50>) 25.000h	<b>Bl</b> Blanco
472166	3,2W	400lm	<b>4</b>	4.000K (L70B50>) 25.000h	<b>Bl</b> Blanco
472135	3,2W	380lm	<b>3</b>	3.000K (L70B50>) 25.000h	<b>N</b> Negro
472142	3,2W	400lm	<b>4</b>	4.000K (L70B50>) 25.000h	<b>N</b> Negro
472173*	3,2W	380lm	<b>3</b>	3.000K (L70B50>) 25.000h	<b>Gr</b> Gris
472180	3,2W	400lm	<b>4</b>	4.000K (L70B50>) 25.000h	<b>Gr</b> Gris

## Summet 6,8W

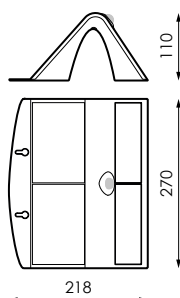

▮	W <sub>T</sub>	φ <sub>T</sub>	K	⏏	⊗
472210	6,8W	760lm	<b>3</b>	3.000K (L70B50>) 25.000h	<b>Bl</b> Blanco
472227	6,8W	800lm	<b>4</b>	4.000K (L70B50>) 25.000h	<b>Bl</b> Blanco
472197	6,8W	760lm	<b>3</b>	3.000K (L70B50>) 25.000h	<b>N</b> Negro
472203	6,8W	800lm	<b>4</b>	4.000K (L70B50>) 25.000h	<b>N</b> Negro
472234*	6,8W	760lm	<b>3</b>	3.000K (L70B50>) 25.000h	<b>Gr</b> Gris
472241	6,8W	800lm	<b>4</b>	4.000K (L70B50>) 25.000h	<b>Gr</b> Gris

\*Hasta fin de existencias/\* Until end of stock/\* Jusqu'à épuisement des stocks/\* Enquanto os estoques durarem

### INFORMACIÓN / INFORMATION / INFORMATION / INFORMAÇÕES

Ñ/ Batería reemplazable en los modelos de 3,2W y 6,8W

E/ Replaceable battery in 3,2W and 6,8W models

F/ Batterie remplaçable dans les modèles 3,2W et 6,8W

P/ Bateria substituível nos modelos 3,2W e 6,8W







Green



# Masne



**Sensor de Presencia (PIR)**  
 Presence Sensor (PIR)  
 Capteur de Présence (PIR)  
 Sensor de Presença (PIR)



Masne Sensor



Masne



	Hz	$\phi$							
220-240V ac	50-60Hz	>0,5	CII	IP54	120°	>80	(L70B50>) 25.000h	PC-O	ABS

## ACCESORIOS / ACCESSOIRES / ACCESSORIES / ACESSÓRIOS

+ INFO PAG. 200



468770

Carcasa rejilla blanca S

468800

Carcasa rejilla blanca L



468831

Carcasa decorativa blanca S

468862

Carcasa decorativa blanca L

468787

Carcasa rejilla negra S

468817

Carcasa rejilla negra L

468848

Carcasa decorativa negra S

468879

Carcasa decorativa negra L

468794

Carcasa rejilla gris S

468824

Carcasa rejilla gris L

468855

Carcasa decorativa gris S

468886

Carcasa decorativa gris L

# Masne

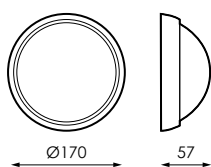

S

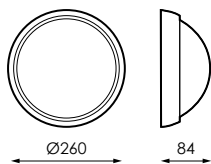

L

		$W_t$	$\phi_t$	K		
468510	S	8W	603lm	4	4.000K	BI RAL 9003
468527	S	8W	586lm	3	3.000K	BI RAL 9003
468534	S	8W	603lm	4	4.000K	N RAL 9004
468541	S	8W	586lm	3	3.000K	N RAL 9004
468558	S	8W	603lm	4	4.000K	Gr RAL 7040
468565	S	8W	586lm	3	3.000K	Gr RAL 7040
468572	L	15W	1.217lm	4	4.000K	BI RAL 9003
468589	L	15W	1.087lm	3	3.000K	BI RAL 9003
468596	L	15W	1.217lm	4	4.000K	N RAL 9004
468602	L	15W	1.087lm	3	3.000K	N RAL 9004
468619	L	15W	1.217lm	4	4.000K	Gr RAL 7040
468626	L	15W	1.087lm	3	3.000K	Gr RAL 7040

# Masne Sensor

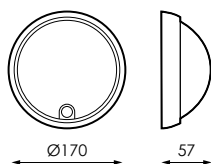

S sensor

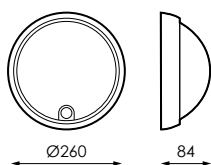

L sensor

		$W_t$	$\phi_t$	K		
468633	S	8W	603lm	4	4.000K	BI RAL 9003
468664	S	8W	586lm	3	3.000K	BI RAL 9003
468671	S	8W	603lm	4	4.000K	N RAL 9004
468688	S	8W	586lm	3	3.000K	N RAL 9004
468695	S	8W	603lm	4	4.000K	Gr RAL 7040
468701	S	8W	586lm	3	3.000K	Gr RAL 7040
468718	L	15W	1.217lm	4	4.000K	BI RAL 9003
468725	L	15W	1.087lm	3	3.000K	BI RAL 9003
468732	L	15W	1.217lm	4	4.000K	N RAL 9004
468749	L	15W	1.087lm	3	3.000K	N RAL 9004
468756	L	15W	1.217lm	4	4.000K	Gr RAL 7040
468763	L	15W	1.087lm	3	3.000K	Gr RAL 7040

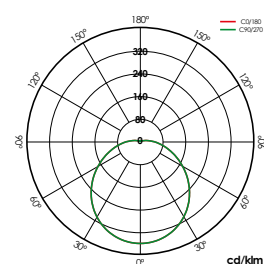

15W



# Anzio

**N**  
NEW



Sensor de Presencia (PIR)  
Presence Sensor (PIR)  
Capteur de Présence (PIR)  
Sensor de Presença (PIR)



Anzio



Anzio Sensor

	Hz									
230V ac	50-60Hz	CII	IP65	IK08	-10°C~+35 °C	124°	>80	(L70B50>) 25.000h	PC-O	PC







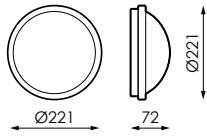

[GRÁFICOS: Unidades en mm/ GRÁFICOS: Units in mm/GRAPHIQUES: Unités en mm/GRÁFICOS: Unidades em mm]



# Anzio







	$W_T$	$\phi_T$		K		
<b>N</b> 586092	20W	1.927lm		3.000K	<b>BI</b>	Blanco
378024	20W	2.160lm		4.000K	<b>BI</b>	Blanco
<b>N</b> 586108	20W	1.927lm		3.000K	<b>N</b>	Negro
378031	20W	2.160lm		4.000K	<b>N</b>	Negro

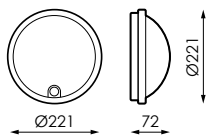

# Anzio Sensor



	$W_T$	$\phi_T$		K		
<b>N</b> 590082	20W	1.927lm		3.000K	<b>BI</b>	Blanco
<b>N</b> 590099	20W	2.160lm		4.000K	<b>BI</b>	Blanco

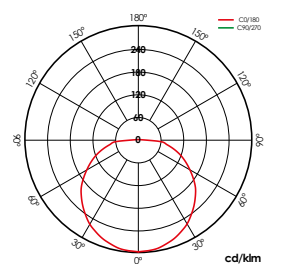

20W

**Sensor de Presencia (PIR)**  
 Presence Sensor (PIR)  
 Capteur de Présence (PIR)  
 Sensor de Presença (PIR)



Lucca



Lucca Sensor

										
230V ac	50-60Hz	CII	IP65	IK08	-10°C~+35 °C	127°	>80	(L70B50>) 25.000h	PC-O	PC



[GRÁFICOS: Unidades en mm/ GRÁFICOS: Units in mm/GRÁFICOS: Units en mm/GRÁFICOS: Unidades em mm]

# Lucca

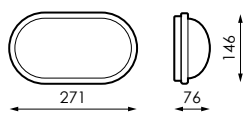

	$W_T$	$\phi_T$		K		
<b>N</b> 586115	18W	1.881lm	<b>3</b>	3.000K	<b>BI</b>	Blanco
378048	18W	1.950lm	<b>4</b>	4.000K	<b>BI</b>	Blanco
<b>N</b> 586122	18W	1.881lm	<b>3</b>	3.000K	<b>N</b>	Negro
378055	18W	1.950lm	<b>4</b>	4.000K	<b>N</b>	Negro



# Lucca Sensor

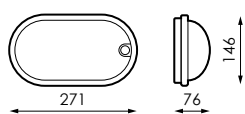

	$W_T$	$\phi_T$		K		
<b>N</b> 590105	18W	1.881lm	<b>3</b>	3.000K	<b>BI</b>	Blanco
<b>N</b> 590112	18W	1.950lm	<b>4</b>	4.000K	<b>BI</b>	Blanco

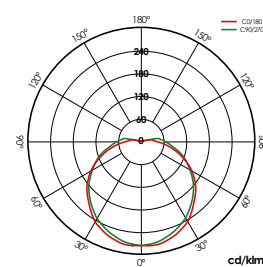

18W



# Merk



Barcode	W <sub>T</sub>	φ	K	Color
495288	3W	76lm	<b>3</b> 3.000K	<b>Gr</b> Gris RAL 7010
495295	3W	81lm	<b>4</b> 4.000K	<b>Gr</b> Gris RAL 7010

  

	Hz									
100-240V ac	50-60Hz	CI	IP54	-10°C~+35 °C	80°	>80	(L70B50>) 30.000h	VT-T	AL	EMPOTRABLE

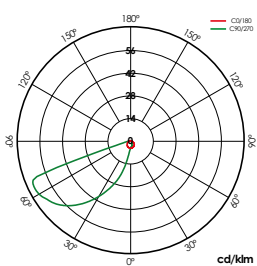
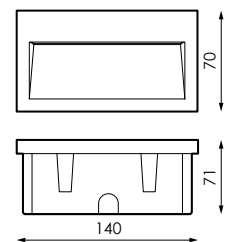

3W



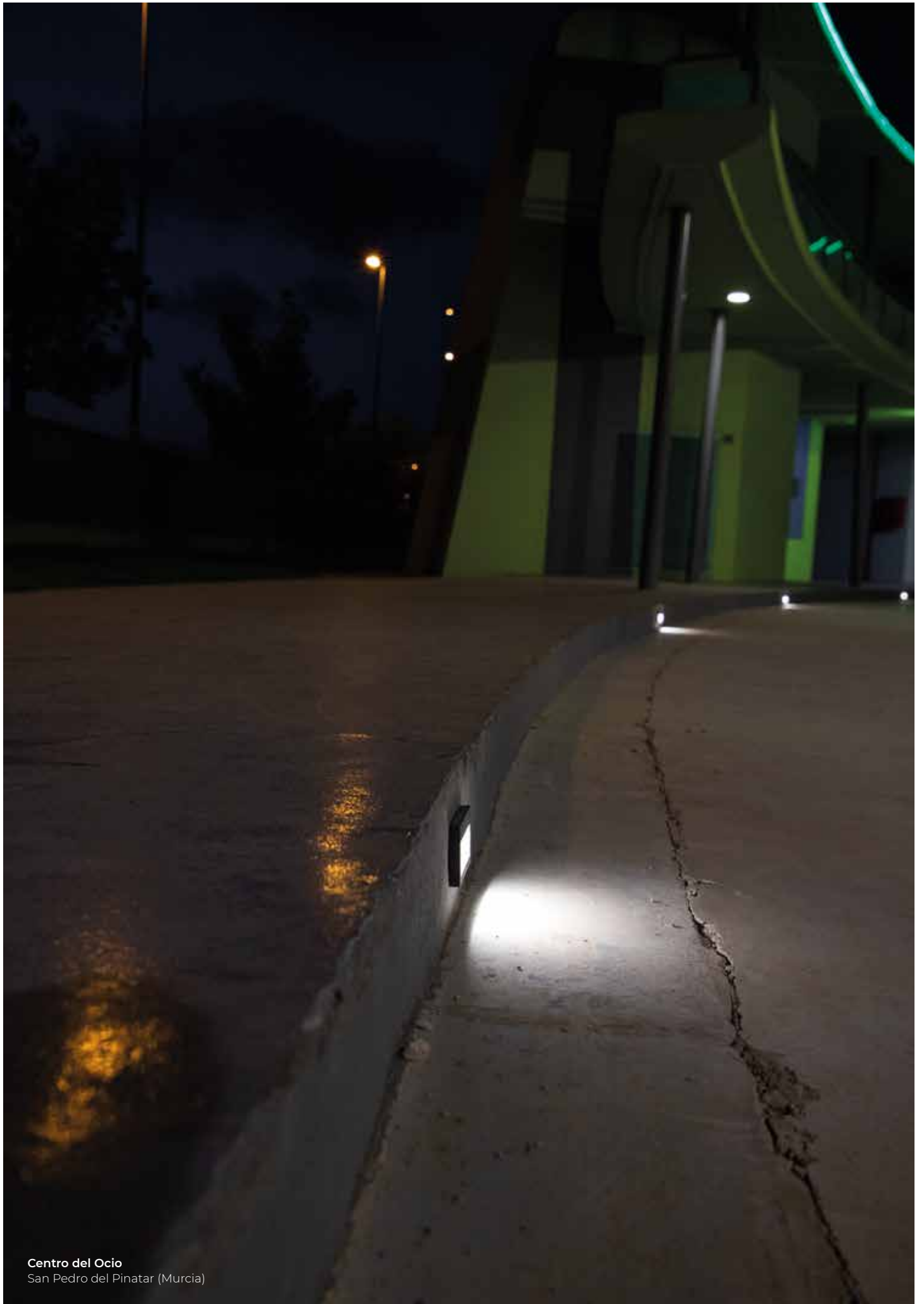

[GRÁFICOS: Unidades en mm/ GRÁFICOS: Units in mm/GRÁFICOS: Unidades en mm/GRÁFICOS: Unidades en mm]

**Centro del Ocio**  
San Pedro del Pinatar (Murcia)

# Hank



Barcode	W <sub>r</sub>	φ	K	Gr
495301	3W	77mm	<b>3</b> 3.000K	<b>Gr</b> Gris RAL 7010
495318	3W	82mm	<b>4</b> 4.000K	<b>Gr</b> Gris RAL 7010

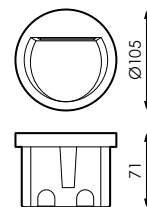

	Hz									
100-240V ac	50-60Hz	CI	IP54	-10°C~+35 °C	80°	>80	(L70B50>) 30.000h	VT-T	AL	EMPOTRABLE

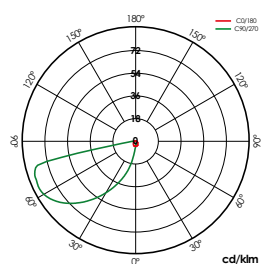

3W

# Arette

## Avant



6W



12W

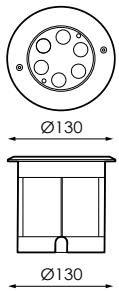

6W

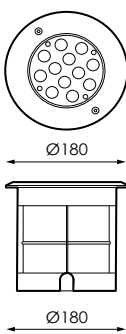

12W



	W <sub>LED</sub>	W <sub>T</sub>	φ	φ <sub>LED</sub>	φ <sub>T</sub>	K	
483605	5W	6W	>0,9	702lm	583lm	4	4.000K 6
483612	10,5W	12W	>0,9	1496lm	1230lm	4	4.000K 12

	Hz									
100-240V ac	50-60Hz	CI	IP67	K08 (12W) IK09 (6W)	(L70B50>) 50.000h	>70	2.000kg	PVC	FE INOX	EMPOTRABLE

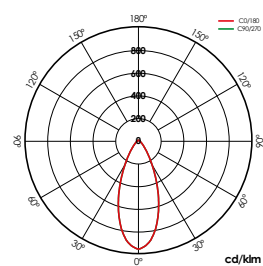

6W

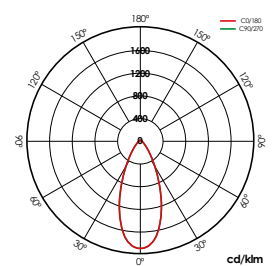

12W

# Niza



Barcode	$W_{LED}$	$W_T$	$\phi_{LED}$	$\phi_T$	K	Color	Finish	Beam Spread	
410113	20W	22W	2.861lm	2.345lm	3	3.000K	Gr	RAL 7010	9
410120	20W	22W	3.076lm	2.399lm	4	4.000K	Gr	RAL 7010	9

Voltage	Frequency	Power Factor	Protection Class	Ingress Protection	IK Rating	Temp. Range	Temp. Rise	Life Span	Dimming	Material
100-240V	50-60Hz	0.90	CI	IP65	IK08	-10°C~+35°C	28°	>80 (L70B50->)	40.000h	VT-P AL

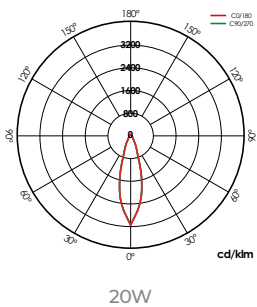
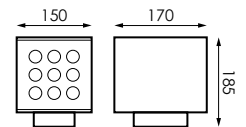

## INFORMACIÓN / INFORMATION / INFORMATION / INFORMAÇÕES

Ñ/ La instalación de la luminaria NIZA debe realizarse únicamente hacia abajo

E/ NIZA's installation should only be done downwards

F/ L'installation de NIZA ne doit être effectuée que vers le bas

P/ A instalação da NIZA só deve ser feita para baixo

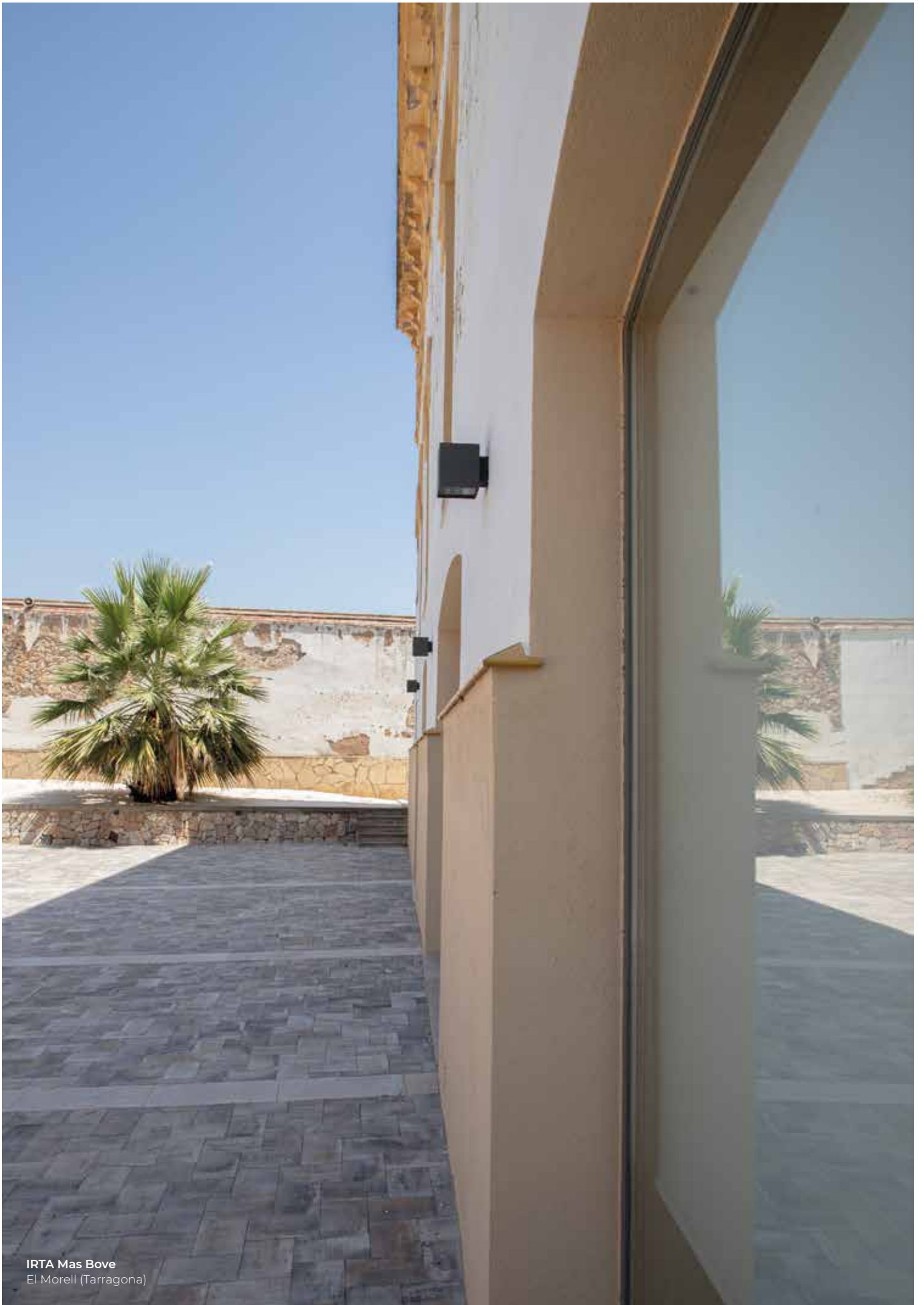

IRTA Mas Bove  
El Morell (Tarragona)



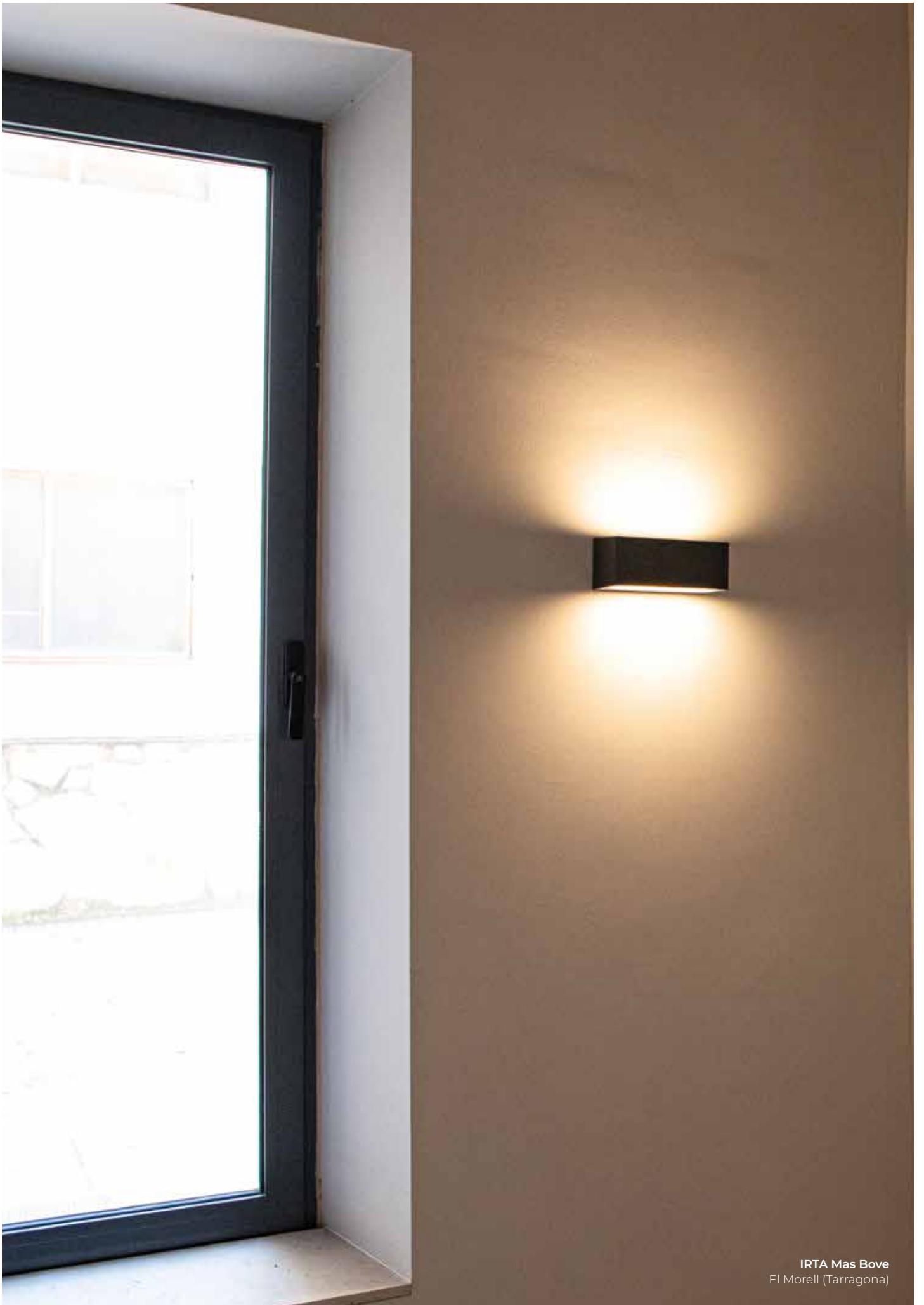

IRTA Mas Bove  
El Morell (Tarragona)

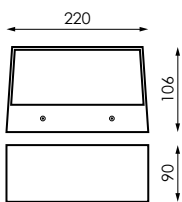

	$W_{LED}$	$W_T$	$\phi_{LED}$	$\phi_T$	K		
410052	12W	15W	786lm	552lm	<b>3</b>	3,000K	<b>Gr</b> RAL 7010
410069	12W	15W	848lm	593lm	<b>4</b>	4,000K	<b>Gr</b> RAL 7010
<b>N</b> 522816	12W	15W	786lm	552lm	<b>3</b>	3,000K	<b>Bl</b> RAL 9003
<b>N</b> 522823	12W	15W	848lm	593lm	<b>4</b>	4,000K	<b>Bl</b> RAL 9003

		$\phi$								
100-240V	50-60Hz	0.90	CI	IP65	IK08	-10°C~+35°C	100°	>80	(L70B50>) 40.000h	VT-T AL

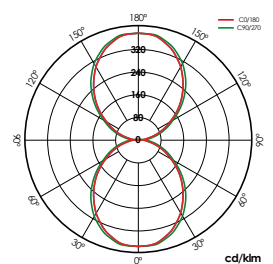

12W

# Sura



		$W_{LED}$	$W_T$	$\phi_{LED}$	$\phi_T$	K			
410076	Directo	6W	7W	522lm	454lm	3	3.000K	Gr	RAL 7010
410083	Directo	6W	7W	561lm	488lm	4	4.000K	Gr	RAL 7010
410090	Directo/Indirecto	12W	14W	1.044lm	908lm	3	3.000K	Gr	RAL 7010
410106	Directo/Indirecto	12W	14W	1.122lm	976lm	4	4.000K	Gr	RAL 7010

	Hz	$\phi$									
100-240V	50-60Hz	0.54	CI	IP65	IK08	-10°C~+35°C	77°	>80 (L70B50>)	40.000h	VT-T	AL

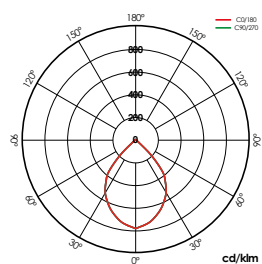
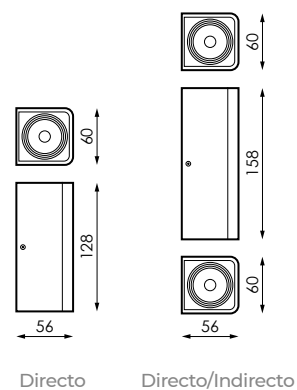

Directo 6W

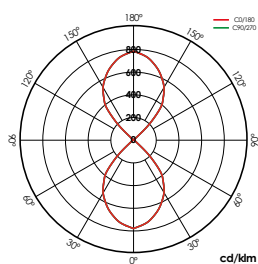

Directo/Indirecto 12W



Ñ/ Ángulo de apertura de las aletas 0-90°. E/ Flap's opening angle 0-90°. F/ Angle d'ouverture du rabat 0-90°. P/ Ângulo de abertura das aletas 0-90°.

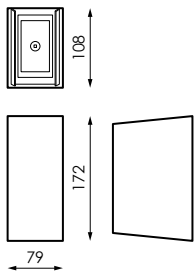

	$W_T$	$\phi_T$	K		
166225	2 x 3W	600lm	<b>4</b>	4.000K <b>Gr</b> Gris	
	Hz				
230V ac	50-60Hz	CI	IP54	>80	(L70B50>) 30.000h VT-T AL

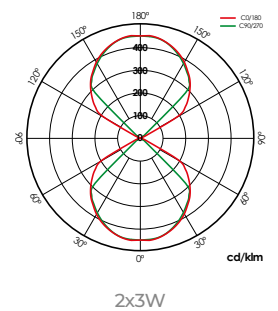

## INFORMACIÓN / INFORMATION / INFORMATION / INFORMAÇÕES

Ñ/ Pestañas abatibles.

E/ Folding flaps.

F/ Rabats pliantes.

P/ Palas orientáveis de luz

# Creus



	$W_T$	$\phi_T$	K	$\infty$		
166577*	2 x 3W	552lm	4.5 4.500K	Gr Gris		
*Hasta fin de existencias/* Until end of stock/* Jusqu'à épuisement des stocks/* Enquanto os estoques durarem						
	Hz					
230V ac	50-60Hz	CI	IP54	>80 (L70B50>) 30.000h	VT-T	AL

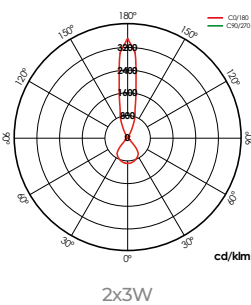
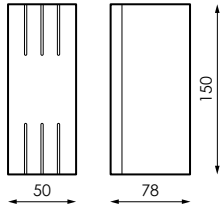





# Albir



Barcode	W <sub>T</sub>	φ <sub>T</sub>	K	Color
163200*	6W	540lm	<b>3</b> 3.000K	<b>Gr</b> Gris

\*Hasta fin de existencias/\* Until end of stock/\* Jusqu'à épuisement des stocks/\* Enquanto os estoques durarem

Voltage	Frequency	Protection	Beam Angle	Life Span	Material
230V ac	50-60Hz	CI	IP54	120° >80 (L70B50>) 30.000h	PC-O AL

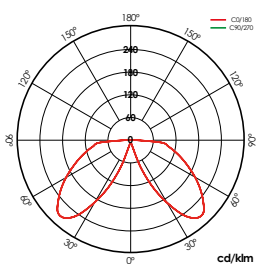
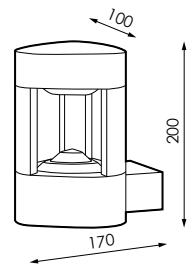

6W

Recomendación  
Recommendation  
Recommandation  
Recomendação

icon  
basic

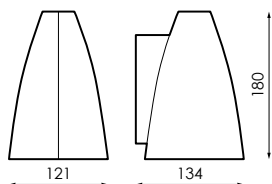

	$W_T$					
166584*	Máx. 35W	Gr Gris				
*Hasta fin de existencias/* Until end of stock/* Jusqu'à épuisement des stocks/* Enquanto os estoques durarem						
	Hz					
230V ac	50-60Hz	CI	IP54	GU10	VT-T	AL

## INFORMACIÓN / INFORMATION / INFORMATION / INFORMAÇÕES

Ñ/ Tamaño máximo lámpara 170mm altura

E/ Maximum lamp size 170mm height

F/ Taille maximale de la lampe 170mm hauteur

P/ Tamanho máximo da lâmpada 170mm altura

## AVISO / WARNING / AVERTISSEMENT / AVISO

Ñ/ Lámpara no incluida

E/ Not included lamp

F/ Lampe non incluse

P/ Lâmpada não incluída.

# Catt



Barcode	W <sub>T</sub>	Φ <sub>T</sub>	K	Color
495264	6W	398lm	<b>3</b> 3.000K	Gr Gris RAL 7010
495271	6W	411lm	<b>4</b> 4.000K	Gr Gris RAL 7010

  

230V ac	Cl	IP65	-10°C~+35 °C	50°	>70	(L70B50>) 30.000h	VT-T	AL

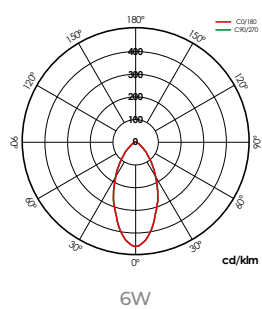
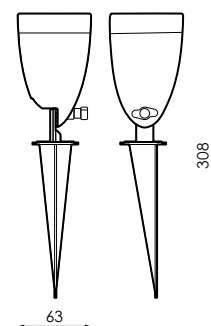





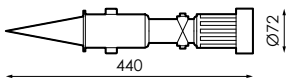

# Pincho jardín

Recomendación *icon*  
 Recommendation *Par 38*  
 Recommendation  
 Recomendação 



		
002059	Máx. 80W	<b>N</b> Negro
		
230V ac	IP44	E27 TP

AVISO / WARNING / AVERTISSEMENT / AVISO

Ñ/ Lámpara no incluida

E/ Not included lamp

F/ Lampe non incluse

P/ Lâmpada não incluída.



# Boiro II

<i>icon basic</i>	<i>icon Evo smart</i>	Recomendación
		Recommendation
		Recommandation
		Recomendação



	$W_T$				
182089	6W LED			 Gris	
					
230V ac	CI	IP54	GU10	VT-T	AL

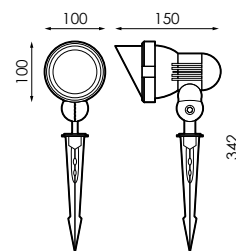

AVISO / WARNING / AVERTISSEMENT / AVISO

Ñ/ Lámpara no incluida

E/ Not included lamp

F/ Lampe non incluse

P/ Lâmpada não incluída.

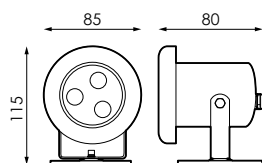

	$W_{LED}$	$W_T$	$\phi_{LED}$	$\phi_T$	K			
234443	6,9W	8W	816lm	607lm	<b>6,5</b> 6.500K	Inox	Inox	3
	$\phi$							
12V ac	0,81	CIII	IP68	IK08	30°	>70	(L70B50->) 30.000h	180° FE INOX

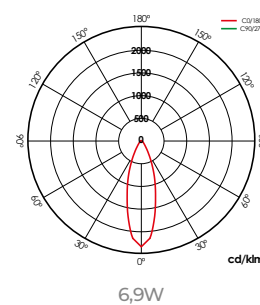

## ACCESORIOS / ACCESSOIRES / ACCESSORIES / ACESSÓRIOS

+ INFO PAG. 200



534062  
Transformador magnético máx.  
300W



534352  
Transformador magnético máx.  
500W



# Agua Avant

ABS











 **Hasta 5 años de garantía**  
**Up to 5 years of warranty**  
**Jusqu'à 5 ans de garantie**  
**Alé 5 anos de garantia**

Ñ/ Posibilidad de cambio de lámpara con la piscina llena. Mediante un cable enrollado dentro del nicho se puede extraer la lámpara fuera del agua y así poder cambiarla sin necesidad de vaciar la piscina. Profundidad máxima de instalación 2 metros. E/ Possibility of changing lamps with up pool. Through a rolled up inside the niche cable can remove the lamp out of the water so you can change it without draining the pool. Maximum depth of installation is 2 meters. F/ Possibilité de changer les lampes jusqu'à la piscine. Grâce à un roulé à l'intérieur du câble de niche peut retirer la lampe hors de l'eau de sorte que vous pouvez le changer sans vider la piscine. Profondeur maximale de l'installation est de 2 mètres. P/ Possibilidade de mudar a lâmpada com a piscina cheia. Por meio de um cabo enrolado dentro da caixa, pode remover a lâmpada sem necessidade de esvaziar a piscina. A profundidade máxima de instalação é de 2 metros.



	W <sub>LED</sub>	W <sub>T</sub>		φ <sub>LED</sub>	φ <sub>T</sub>	K
498180	20W	22W	1.650mA	2.059lm	1.709lm	<b>3</b> 3.000K
539104	20W	22W	1.650mA	2.161lm	1.793lm	<b>5</b> 5.000K
539111	18W	20W	1.500mA	-	-	<b>R G B</b> RGB SINCRO
539128	18W	20W	1.500mA	-	-	<b>R G B</b> RGB ON/OFF

	Hz				A							
12V ac	50-60Hz	CIII	IP68	IK08	100°	(L70B50>)	50.000h	SIN TRAF0	BL	ABS	ABS	EMPOTRABLE

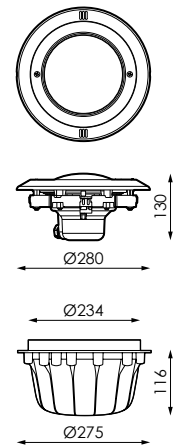

## ACCESORIOS / ACCESSOIRES / ACCESSORIES / ACESSÓRIOS

+ INFO PAG. 200



164122\*  
Sincronizador wireless (Válido para 534055)



442374  
Controlador RGB con mando (Válido para 539111)



534062  
Transformador magnético máx. 300W



534352  
Transformador magnético máx. 500W

Ñ/ Sin mando a distancia. Profundidad máxima de instalación 2 metros. E/ Without remote control. Maximum depth of installation is 2 meters. F/ Sans télécommande. Profondeur maximale de l'installation est de 2 mètres. P/ Sem controle remoto. A profundidade máxima de instalação é de 2 metros.

# Hydra

## Avant

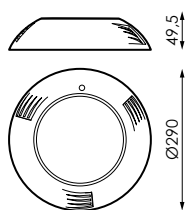

	W <sub>LED</sub>	W <sub>T</sub>		φ <sub>LED</sub>	φ <sub>T</sub>	K
442343	22W	25W	1.800mA	2.449lm	1.935lm	5 5.000K
442367	22W	25W	1.800mA	-	-	R G B RGB SINCRO
442350	22W	25W	1.800mA	-	-	R G B RGB ON/OFF

	Hz											
12V ac	50-60Hz	CIII	IP68	IK08	120°	>70	(L70B50>)	30.000h	SIN TRA-FO	BL	ABS	PC-T SUPERFICIE

### ACCESORIOS / ACCESSOIRES / ACCESSORIES / ACESSÓRIOS

+ INFO PAG. 200



164122\*  
Sincronizador wireless (Válido para 534055)



442374  
Controlador RGB con mando (Válido para 539111)



534062  
Transformador magnético máx. 300W



534352  
Transformador magnético máx. 500W

# Accesorios

Accessories

Accessoires

Acessórios

		Iseo	Masne S	Masne L	Masne S Sensor	Masne L Sensor	Agua AVANT ABS	Hydra AVANT
⚡	534062	•					•	•
	534352	•					•	•
↑	468770		•		•			
	468787		•		•			
	468794		•		•			
	468800			•		•		
	468817			•		•		
	468824			•		•		
	468831		•		•			
	468848		•		•			
	468855		•		•			
	468862			•		•		
	468879			•		•		
	468886			•		•		
+ xo	164122						•	•
	442374						•	•



442374

Controlador RGB con mando, máx. 20 luminarias (Válido para RGB SINCRO).  
 Controller RGB with control, max. 20 luminaires (Valid for RGB SINCRO).  
 Contrôleur RGB avec contrôle, max. 20 luminaires (Valide pour RGB SINCRO).  
 Controlador RGB com controle, máx. 20 luminárias (Válido para RGB SINCRO).



164122\*

Sincronizador wireless para control RGB con mando a distancia (consultar esquema de conexionado)(Válido para RGB ON/OFF).  
 Wireless synchronizer for controlling RGB with remote control(consult the wiring diagram)(Valid for RGB ON/OFF).  
 Synchronizer wireless pour contrôle RGB avec télécommande (consultez le schéma de connexion)(Valide pour RGB ON/OFF).  
 Sincronizador wireless para controlo RGB com controle remoto (consulte o esquema da conexão) (Válido para RGB ON/OFF).

\*Hasta fin de existencias/\* Until end of stock/\* Jusqu'à épuisement des stocks/\* Enquanto os estoques durarem





534062

Transformador magnético máx. 300W 12V ac IP65. LED  
 Magnetic transformer max. 300W 12V ac IP65. LED  
 Transformateur magnétique max. 300W 12V ac IP65. LED  
 Transformador magnético max. 300W 12V ac IP65. LED



534352

Transformador magnético máx. 500W 12V ac IP65. LED  
 Magnetic transformer max. 500W 12V ac IP65. LED  
 Transformateur magnétique max. 500W 12V ac IP65. LED  
 Transformador magnético max. 500W 12V ac IP65. LED



468770

Carcasa rejilla blanca Masne S  
 White grid housing Masne S  
 Boîtier en grille blanche Masne S  
 Carcaça de grade branca Masne S

468800

Carcasa rejilla blanca Masne L  
 White grid housing Masne L  
 Boîtier en grille blanche Masne L  
 Carcaça de grade branca Masne L



468794

Carcasa rejilla gris Masne S  
 Grey grid housing Masne S  
 Boîtier en grille gris Masne S  
 Carcaça de grade cinzento Masne S

468824

Carcasa rejilla gris Masne L  
 Grey grid housing Masne L  
 Boîtier en grille gris Masne L  
 Carcaça de grade cinzento Masne L



468787

Carcasa rejilla negra Masne S  
 Black grid housing Masne S  
 Boîtier en grille noir Masne S  
 Carcaça de grade preto Masne S

468817

Carcasa rejilla negra Masne L  
 Black grid housing Masne L  
 Boîtier en grille noir Masne L  
 Carcaça de grade preto Masne L



468831

Carcasa decorativa blanca Masne S  
 White decorative housing Masne S  
 Boîtier décorative blanche Masne S  
 Carcaça decorativa branca Masne S

468862

Carcasa decorativa blanca Masne L  
 White decorative housing Masne L  
 Boîtier décorative blanche Masne L  
 Carcaça decorativa branca Masne L



468855

Carcasa decorativa gris Masne S  
 Grey decorative housing Masne S  
 Boîtier décorative gris Masne S  
 Carcaça decorativa cinzento Masne S

468886

Carcasa decorativa gris Masne L  
 Grey decorative housing Masne L  
 Boîtier décorative gris Masne L  
 Carcaça decorativa cinzento Masne L



468848

Carcasa decorativa negra Masne S  
 Black decorative housing Masne S  
 Boîtier décorative noir Masne S  
 Carcaça decorativa preto Masne S

468879

Carcasa decorativa negra Masne L  
 Black decorative housing Masne L  
 Boîtier décorative noir Masne L  
 Carcaça decorativa preto Masne L



AJUNTA

CARPINTERIA DE ALUM

CERRAJERIA - MUEBLES - PORMENOS A DITOS - BARRERAS

T. 681 673 304

CARPINTERIA DE ALUM

CERRAJERIA - MUEBLES - PORMENOS A DITOS - BARRERAS

T. 681 673 304

# Proyectores

Projectors  
Projecteurs  
Projetores

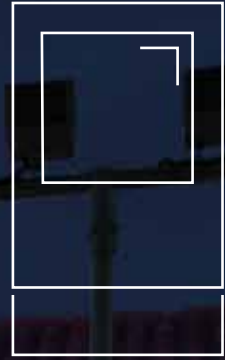

# Chio Avant



Ñ/ Carril electrificado trifásico y accesorios en blanco, negro y gris. Adaptador para carril trifásico 250V 6A. E/ Three-phase electrified rail and accessories in white, black and grey. Adapter for three phase track 250V 6A. F/ Rail électrique triphasé et accessoires en blanc, noir et gris. Adaptateur pour le montage à trois phases voies 250V 6A. P/ Calha electrificada trifásica e acessórios em branco, preto e cinza. Alimentador para calha trifásica 250V 6A.



20W



30W



	Hz	$\phi$			$\Delta$		
220-240V ac	50-60Hz	> 0,9	CII	IP20	36°	>90	(L70B50>) 30.000h

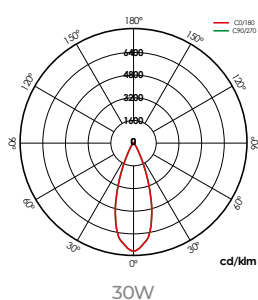
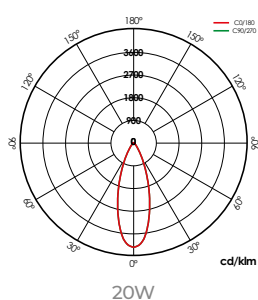

[GRÁFICOS: Unidades en mm/ GRAPHICS: Units in mm/ GRÁFICOS: Unidades en mm/ GRÁFICOS: Unidades en mm]



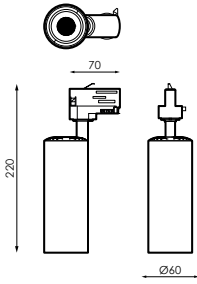

## Chio Avant 20W

	W <sub>LED</sub>	W <sub>T</sub>	φ <sub>LED</sub>	φ <sub>T</sub>	K	∅
580144	18W	20W	2.206lm	1.851lm	<b>3</b>	3.000K <b>BI</b> Blanco
580151	18W	20W	2.367lm	1.986lm	<b>4</b>	4.000K <b>BI</b> Blanco
580168	18W	20W	2.206lm	1.851lm	<b>3</b>	3.000K <b>N</b> Negro
580175	18W	20W	2.367lm	1.939lm	<b>4</b>	4.000K <b>N</b> Negro

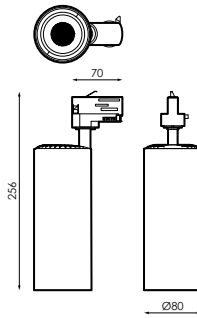

## Chio Avant 30W

	W <sub>LED</sub>	W <sub>T</sub>	φ <sub>LED</sub>	φ <sub>T</sub>	K	∅
580182	27W	30W	3.645lm	3.059lm	<b>3</b>	3.000K <b>BI</b> Blanco
580199	27W	30W	3.727lm	3.128lm	<b>4</b>	4.000K <b>BI</b> Blanco
580205	27W	30W	3.645lm	3.059lm	<b>3</b>	3.000K <b>N</b> Negro
580212	27W	30W	3.727lm	3.128lm	<b>4</b>	4.000K <b>N</b> Negro

### ACCESORIOS / ACCESSOIRES / ACCESSORIES / ACESSÓRIOS

+ INFO PAG. 216



484565

Lente 24° 20W



484572

Lente 24° 30W



484541

Accesorio 20W blanco oval snoot



484558

Accesorio 20W negro oval snoot



484626

Accesorio 30W blanco oval snoot



484633

Accesorio 30W negro oval snoot



# Chio

Ñ/ Carril electrificado trifásico y accesorios en blanco, negro y gris. Adaptador para carril trifásico 250V 6A. E/ Three-phase electrified rail and accessories in white, black and grey. Adapter for three phase track 250V 6A. F/ Rail électrique triphasé et accessoires en blanc, noir et gris. Adaptateur pour le montage à trois phases voies 250V 6A. P/ Ferroviários e ferroviários acessórios disponíveis em branco, preto e cinza. Adaptador para calha trifásica 250V 6A.







20W



30W



	Hz	$\phi$			$\Delta$		
220-240V ac	50-60Hz	> 0,9	CII	IP20	36°	>80	(L70B50>) 30.000h

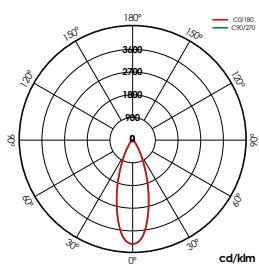

20W

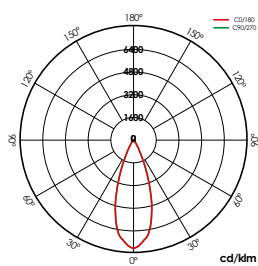

30W

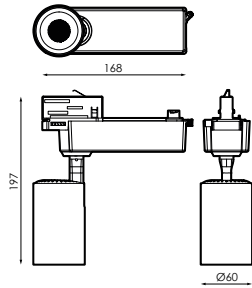

## Chio 20W

	W <sub>LED</sub>	W <sub>T</sub>	φ <sub>LED</sub>	φ <sub>T</sub>	K	⊗
484442*	18W	20W	2.206lm	1.851lm	<b>3</b>	3.000K <b>BI</b> Blanco
484459*	18W	20W	2.367lm	1.986lm	<b>4</b>	4.000K <b>BI</b> Blanco
484466*	18W	20W	2.206lm	1.851lm	<b>3</b>	3.000K <b>N</b> Negro
484473*	18W	20W	2.367lm	1.939lm	<b>4</b>	4.000K <b>N</b> Negro

\*Hasta fin de existencias/\* Until end of stock/\* Jusqu'à épuisement des stocks/\* Enquanto os estoques durarem

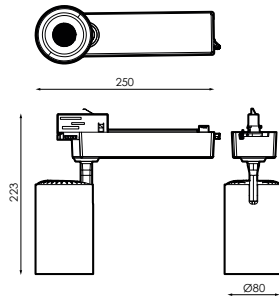

## Chio 30W

	W <sub>LED</sub>	W <sub>T</sub>	φ <sub>LED</sub>	φ <sub>T</sub>	K	⊗
484480*	27W	30W	3.645lm	3.059lm	<b>3</b>	3.000K <b>BI</b> Blanco
484497*	27W	30W	3.727lm	3.128lm	<b>4</b>	4.000K <b>BI</b> Blanco
484503*	27W	30W	3.645lm	3.059lm	<b>3</b>	3.000K <b>N</b> Negro
484510*	27W	30W	3.727lm	3.128lm	<b>4</b>	4.000K <b>N</b> Negro

\*Hasta fin de existencias/\* Until end of stock/\* Jusqu'à épuisement des stocks/\* Enquanto os estoques durarem

### ACCESORIOS / ACCESSOIRES / ACCESSORIES / ACESSÓRIOS

+ INFO PAG. 216



484565

Lente 24° 20W



484572

Lente 24° 30W



484541

Accesorio 20W blanco oval snoot



484558

Accesorio 20W negro oval snoot



484626

Accesorio 30W blanco oval snoot



484633

Accesorio 30W negro oval snoot

# Kenia

**N**  
NEW



**Sensor de Presencia y Luminosidad**  
Presence and Brightness Sensor  
Présence et Capteur de Lumière  
Presença e sensor de luz



**Protector Sobretensiones**  
Surge Protector  
Parasurtenseur  
Protetor Contra Surtos



50W



100W



Sensor 20W

	Hz						
230V ac	50-60Hz	Clase I	IP65	>80	(L70B50>) 25.000h	VT-O	AL



[GRÁFICOS: Unidades en mm/ GRÁFICOS: Units in mm/GRAPHIQUES: Unités en mm/GRÁFICOS: Unidades em mm]



# Kenia

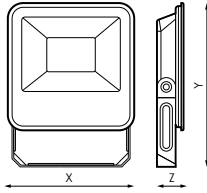

	$W_{LED}$	$\phi_t$	$\phi$	K	$\Delta$					
504638*	10W	911lm	>0,5	<b>3</b>	3.000K	100°	Gr	RAL7045	109 x 90 x 27mm	1kV/2kV
504645*	10W	987lm	>0,5	<b>5</b>	5.000K	100°	Gr	RAL7045	109 x 90 x 27mm	1kV/2kV
504652	20W	1.823lm	>0,5	<b>3</b>	3.000K	100°	Gr	RAL7045	165 x 135 x 30mm	2kV/2kV
504669	20W	1.923lm	>0,5	<b>5</b>	5.000K	100°	Gr	RAL7045	165 x 135 x 30mm	2kV/2kV
504676	30W	2.618lm	>0,9	<b>3</b>	3.000K	110°	Gr	RAL7045	186 x 135 x 30mm	2kV/2kV
504683	30W	2.743lm	>0,9	<b>5</b>	5.000K	110°	Gr	RAL7045	186 x 135 x 30mm	2kV/2kV
522533	30W	2.743lm	>0,9	<b>3</b>	5.000K	110°	Bl	Blanco	186 x 135 x 30mm	2kV/2kV
504690	50W	4.371lm	>0,9	<b>5</b>	3.000K	110°	Gr	RAL7045	240 x 180 x 30mm	2kV/2kV
504706	50W	4.516lm	>0,9	<b>3</b>	5.000K	110°	Gr	RAL7045	240 x 180 x 30mm	2kV/2kV
522540	50W	4.516lm	>0,9	<b>5</b>	5.000K	110°	Bl	Blanco	240 x 180 x 30mm	2kV/2kV
504713	70W	6.203lm	>0,9	<b>3</b>	3.000K	110°	Gr	RAL7045	287 x 243 x 37mm	1kV/2kV
504720	70W	6.318lm	>0,9	<b>5</b>	5.000K	110°	Gr	RAL7045	287 x 243 x 37mm	1kV/2kV
504737	100W	8.711lm	>0,9	<b>3</b>	3.000K	110°	Gr	RAL7045	313 x 243 x 37mm	2kV/2kV
504744	100W	8.839lm	>0,9	<b>5</b>	5.000K	110°	Gr	RAL7045	313 x 243 x 37mm	2kV/2kV

\*Hasta fin de existencias/\* Until end of stock/\* Jusqu'à épuisement des stocks/\* Enquanto os estoques durarem



# Kenia Sensor

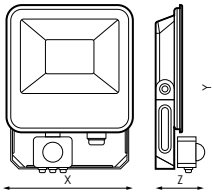

	$W_{LED}$	$\phi_t$	$\phi$	K	$\Delta$					
504768	20W	1.923lm	>0,5	<b>5</b>	5.000K	110°	Gr	RAL7045	164 x 135 x 56mm	1kV/2kV
504775	30W	2.743lm	>0,9	<b>5</b>	5.000K	110°	Gr	RAL7045	186 x 135 x 56mm	1kV/2kV
504782	50W	4.516lm	>0,9	<b>5</b>	5.000K	110°	Gr	RAL7045	240 x 180 x 56mm	1kV/2kV

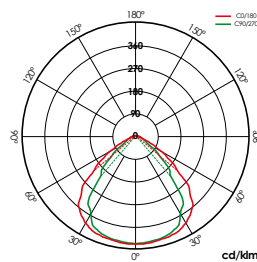

10W

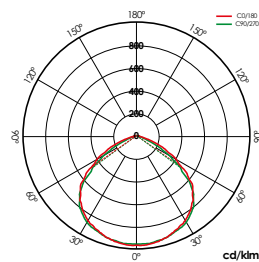

30W

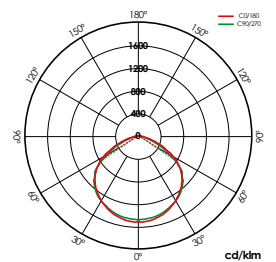

50W

# Hitaka



**Sensor de Presencia y Luminosidad**  
Presence and Brightness Sensor  
Présence et Capteur de Lumière  
Presença e sensor de luz



**Protector Sobretensiones**  
Surge Protector  
Parasurtenseur  
Protetor Contra Surtos



50W



Sensor 20W



## Hitaka

Barcode	W <sub>LED</sub>	φ <sub>T</sub>	K	Color	Material	Dimensions	Protection
534550*	10W	976lm	3	3.000K	Gr	RAL7010 138 x 117 x 27mm	2kV
534574*	20W	1.438lm	3	3.000K	Gr	RAL7010 158 x 134 x 28mm	2kV
534581*	20W	1.576lm	5	5.000K	Gr	RAL7010 158 x 134 x 28mm	2kV
534611*	50W	4.318lm	3	3.000K	Gr	RAL7010 298 x 220 x 39mm	5kV

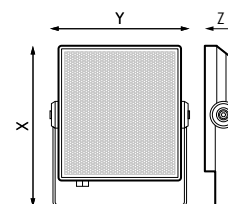

\*Hasta fin de existencias/\* Until end of stock/\* Jusqu'à épuisement des stocks/\* Enquanto os estoques durarem

## Hitaka Sensor

Barcode	W <sub>LED</sub>	φ <sub>T</sub>	K	Color	Material	Dimensions	Protection
468350*	20W	1.438lm	3	3.000K	Gr	RAL7010 158 x 134 x 28mm	2kV

\*Hasta fin de existencias/\* Until end of stock/\* Jusqu'à épuisement des stocks/\* Enquanto os estoques durarem

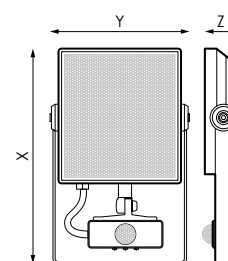

Lightning Bolt	Hz	Ground	IP	Beam Angle	Temp	Life	Material	Finish
230V ac	50-60Hz	Clase I	IP65	>80	-5°C~+35 °C	100° (L70B50>) 25.000h	PC-P	AL

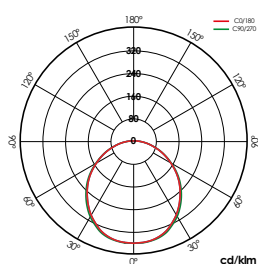

50W



**Protector Sobretensiones**  
Surge Protector  
Parasurtenseur  
Protetor Contra Surtos



160W

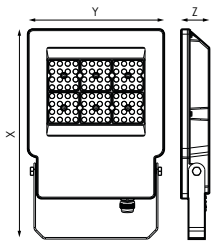

	W <sub>LED</sub>	φ <sub>T</sub>	K	Beam	Life	Color	Finish	Dimensions	Protection
576680	13,5W	2.040lm	3	3.000K (L70B50>)	30.000h	Gr	RAL7010	118 x 184 x 35mm	2kV
576697	13,5W	2.126lm	5	5.000K (L70B50>)	30.000h	Gr	RAL7010	118 x 184 x 35mm	2kV
576703	33W	5.072lm	3	3.000K (L70B50>)	30.000h	Gr	RAL7010	172 x 264 x 45mm	4kV
576710	33W	5.134lm	5	5.000K (L70B50>)	30.000h	Gr	RAL7010	172 x 264 x 45mm	4kV
576727	50W	8.277lm	3	3.000K (L70B50>)	30.000h	Gr	RAL7010	217 x 331 x 45mm	6kV
576734	50W	8.503lm	5	5.000K (L70B50>)	30.000h	Gr	RAL7010	217 x 331 x 45mm	6kV
576741	90W	14.369lm	3	3.000K (L70B50>)	30.000h	Gr	RAL7010	245 x 365 x 52mm	6kV
576758	90W	14.594lm	5	5.000K (L70B50>)	30.000h	Gr	RAL7010	245 x 365 x 52mm	6kV
576765	160W	26.588lm	3	3.000K (L70B50>)	50.000h	Gr	RAL7010	303 x 439 x 60mm	6kV
576772	160W	27.433lm	5	5.000K (L70B50>)	50.000h	Gr	RAL7010	303 x 439 x 60mm	6kV
576789	200W	34.017lm	3	3.000K (L70B50>)	50.000h	Gr	RAL7010	376 x 533 x 66mm	6kV
576796	200W	34.860lm	5	5.000K (L70B50>)	50.000h	Gr	RAL7010	376 x 533 x 66mm	6kV

Input	Frequency	Class	IP	IK	Color Temp	Temp Range	Beam Angle	Material	Aluminum
⚡	Hz	⏚	⦿	🔪	🌸	🌡	∠	📏	📄
230V ac	50-60Hz	Clase I	IP65	IK08	>70	-5°C~+35 °C	90°	VT-T	AL

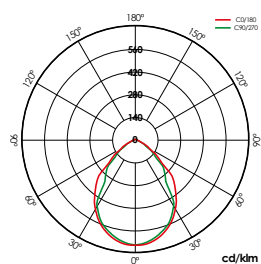

13,5W

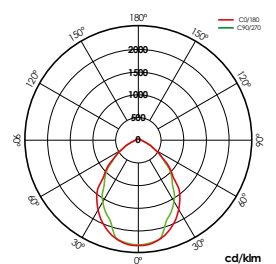

33W

# Energy Tech



**Sensor de Presencia y Luminosidad**  
 Presence and Brightness Sensor  
 Présence et Capteur de Lumière  
 Presença e sensor de luz



**Protector Sobretensiones**  
 Surge Protector  
 Parasurtenseur  
 Protetor Contra Surtos



90W



Sensor 10W

	Hz								
220-240V ac	50-60Hz	Clase I	IP65	IK08	>70	-5°C~+35 °C	90°	VT-T	AL



Colegio Infantil "El Rajolar"  
 Aldaya (Valencia)

[GRÁFICOS: Unidades en mm/ GRAPHSICS: Units in mm/GRAPHIQUES: Unités en mm/GRÁFICOS: Unidades em mm]



# Energy Tech

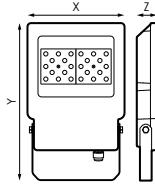

		$W_{LED}$	$\phi_T$	K					
454964*	10W	1.007lm	3	3.000K (L70B50>)	25.000h	Gr	RAL7010	118 x 184 x 35mm	1kV/2kV
454971*	10W	1.018lm	5	5.000K (L70B50>)	25.000h	Gr	RAL7010	118 x 184 x 35mm	1kV/2kV
454988*	20W	2.013lm	3	3.000K (L70B50>)	25.000h	Gr	RAL7010	149 x 228 x 42mm	2kV/2kV
454995*	20W	2.124lm	5	5.000K (L70B50>)	25.000h	Gr	RAL7010	149 x 228 x 42mm	2kV/2kV
455008*	40W	3.868lm	3	3.000K (L70B50>)	25.000h	Gr	RAL7010	172 x 264 x 45mm	2kV/4kV
455015*	40W	4.049lm	5	5.000K (L70B50>)	25.000h	Gr	RAL7010	172 x 264 x 45mm	2kV/4kV
471480*	60W	6.096lm	3	3.000K (L70B50>)	25.000h	Gr	RAL7010	217 x 331 x 45mm	4kV/6kV
471497*	60W	6.425lm	5	5.000K (L70B50>)	25.000h	Gr	RAL7010	217 x 331 x 45mm	4kV/6kV
471503*	90W	10.362lm	3	3.000K (L70B50>)	25.000h	Gr	RAL7010	245 x 365 x 52mm	4kV/6kV
477468*	90W	10.854lm	5	5.000K (L70B50>)	25.000h	Gr	RAL7010	245 x 365 x 52mm	4kV/6kV
471510*	120W	13.965lm	3	3.000K (L70B50>)	25.000h	Gr	RAL7010	272 x 396 x 52mm	4kV/6kV
477475*	120W	14.639lm	5	5.000K (L70B50>)	25.000h	Gr	RAL7010	272 x 396 x 52mm	4kV/6kV
477482*	160W	18.293lm	3	3.000K (L70B50>)	50.000h	Gr	RAL7010	303 x 439 x 60mm	6kV/10kV
477499*	160W	19.248lm	5	5.000K (L70B50>)	50.000h	Gr	RAL7010	303 x 439 x 60mm	6kV/10kV
471527*	200W	22.973lm	3	3.000K (L70B50>)	50.000h	Gr	RAL7010	376 x 533 x 66mm	6kV/10kV
477505*	200W	24.161lm	5	5.000K (L70B50>)	50.000h	Gr	RAL7010	376 x 533 x 66mm	6kV/10kV

\*Hasta fin de existencias/\* Until end of stock/\* Jusqu'à épuisement des stocks/\* Enquanto os estoques durarem

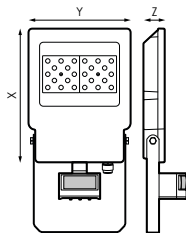

# Energy Tech Sensor



		$W_{LED}$	$\phi_T$	K					
458979	10W	1.018lm	5	5.000K (L70B50>)	25.000h	Gr	RAL7010	118 x 146 x 35mm	1kV/2kV
458986	20W	2.124lm	5	5.000K (L70B50>)	25.000h	Gr	RAL7010	149 x 183 x 42mm	2kV/2kV
458993	40W	4.049lm	5	5.000K (L70B50>)	25.000h	Gr	RAL7010	171 x 212 x 45mm	2kV/4kV

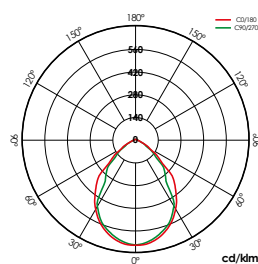

10W

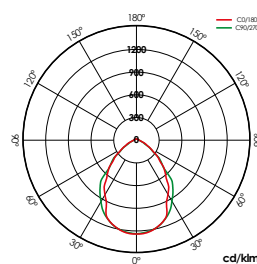

20W

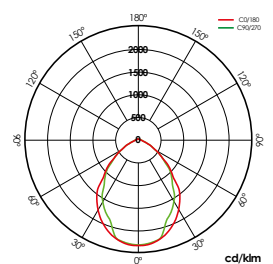

40W

# Energy TECH

## RGB RF

**N**  
NEW



**Efecto memoria**  
Memory effect  
Effet mémoire  
Efeito memória

Ñ/ ENERGY TECH RGB RF con alcance máximo del mando de 40m. E/ ENERGY TECH RGB RF with maximum control range of 40m. F/ ENERGY TECH RGB RF avec une plage de contrôle maximale de 40m. P/ ENERGY TECH RGB RF con alcance máximo del mando de 40m.



20W

50W



Barcode	W <sub>LED</sub>	K	Light Output	Color	Finish	Dimensions	Voltage
N 497602	20W	RGB	(L70B50>) 25.000h	Gr	RAL7010	265 x 172 x 45mm	2kV
497619	50W	RGB	(L70B50>) 25.000h	Gr	RAL7010	331 x 217 x 45mm	4kV

Input Voltage	Frequency	Protection Class	IP Rating	IK Rating	Life Span	Operating Temp	Beam Angle	Beam Type	Material
100-240V ac	50-60Hz	Clase I	IP65	IK08	>70	-5°C~+35 °C	90°	VT-T	AL

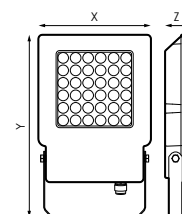

[GRÁFICOS: Unidades en mm/ GRAPHICS: Units in mm/ GRAPHIQUES: Unités en mm/ GRÁFICOS: Unidades em mm]







# Accesorios

Accessories

Accessoires

Acessórios

		Chio 20W	Chio 30W	Chio Avant 20W	Chio Avant 30W
⚡	204002	•	•	•	•
	204019	•	•	•	•
	204071	•	•	•	•
	204096	•	•	•	•
	210034	•	•	•	•
	210041	•	•	•	•
	381734	•	•	•	•
	381741	•	•	•	•
⊖	204026	•	•	•	•
	204033	•	•	•	•
	204057	•	•	•	•
	204064	•	•	•	•
	210058	•	•	•	•
	210065	•	•	•	•
	210072	•	•	•	•
	210089	•	•	•	•
⊗	484565	•		•	
	484572		•		•
☂	484541	•		•	
	484558	•		•	
	484626		•		•
	484633		•		•



484565

Lente Chio 24° 20W  
Chio Lens 24° 20W  
Objectif Chio 24° 20W  
Lente Chio 24° 20W



484572

Lente Chio 24° 30W  
Chio Lens 24° 30W  
Objectif Chio 24° 30W  
Lente Chio 24° 30W



484541

Accesorio chio 20W blanco oval snoot  
Accessory chio 20W white oval snoot  
Accessoire chio 20W blanc ovale snoot  
Acessório chio 20W branco oval snoot oval



484558

Accesorio chio 20W negro oval snoot  
Accessory chio 20W black oval snoot  
Accessoire chio 20W snoot ovale noir  
Acessório chio 20W preto oval snoot oval



484626

Accesorio chio 30W blanco oval snoot  
Accessory chio 30W white oval snoot  
Accessoire chio 30W blanc ovale snoot  
Acessório chio 30W branco oval snoot oval



484633

Accesorio chio 30W negro oval snoot  
Accessory chio 30W black oval snoot  
Accessoire chio 30W snoot ovale noir  
Acessório chio 30W preto oval snoot oval



204002	Carril electrificado 3F+N+TT 16A/ Electrified rail 3F+N+TT 16A/ Rail électrifié 3F+N+TT 16A/ Calha eletrificada 3F+N+TT 16A	<b>BI</b>	Blanco	3.000 x 38 x 34mm
210034	Carril electrificado 3F+N+TT 16A/ Electrified rail 3F+N+TT 16A/ Rail électrifié 3F+N+TT 16A/ Calha eletrificada 3F+N+TT 16A	<b>N</b>	Negro	3.000 x 38 x 34mm
204019	Carril electrificado 3F+N+TT 16A/ Electrified rail 3F+N+TT 16A/ Rail électrifié 3F+N+TT 16A/ Calha eletrificada 3F+N+TT 16A	<b>BI</b>	Blanco	2.000 x 38 x 34mm
210041	Carril electrificado 3F+N+TT 16A/ Electrified rail 3F+N+TT 16A/ Rail électrifié 3F+N+TT 16A/ Calha eletrificada 3F+N+TT 16A	<b>N</b>	Negro	2.000 x 38 x 34mm
381734	Carril electrificado 3F+N+TT 16A/ Electrified rail 3F+N+TT 16A/ Rail électrifié 3F+N+TT 16A/ Calha eletrificada 3F+N+TT 16A	<b>BI</b>	Blanco	1.000 x 38 x 34mm
381741	Carril electrificado 3F+N+TT 16A/ Electrified rail 3F+N+TT 16A/ Rail électrifié 3F+N+TT 16A/ Calha eletrificada 3F+N+TT 16A	<b>N</b>	Negro	1.000 x 38 x 34mm
204071	Alimentador electrico lateral / Lateral electrical feeder/ Latérale d'alimentation électrique/ Alimentador elétrico laterais	<b>BI</b>	Blanco	-
210096	Alimentador electrico lateral / Lateral electrical feeder/ Latérale d'alimentation électrique/ Alimentador elétrico laterais	<b>N</b>	Negro	-
204057	Conector exterior en L con acometida/ External L-connector with feeder function/ Connecteur en L avec la fonction d'alimentation/ L-conector exterior com função de alimentador	<b>BI</b>	Blanco	-
210058	Conector exterior en L con acometida/ External L-connector with feeder function/ Connecteur en L avec la fonction d'alimentation/ L-conector exterior com função de alimentador	<b>N</b>	Negro	-
204033	Conector lineal exterior con acometida/ External lineal connector with feeder function/ Connecteur linéaire externe avec la fonction d'alimentation/ Conector linear externo com função de alimentador	<b>BI</b>	Blanco	-
210065	Conector lineal exterior con acometida/ External lineal connector with feeder function/ Connecteur linéaire externe avec la fonction d'alimentation/ Conector linear externo com função de alimentador	<b>N</b>	Negro	-
204064	Conector lineal interior con acometida/ Indoor lineal connector with feeder function/ Connecteur linéaire intérieure avec la fonction d'alimentation/ Conector linear interior com função de alimentador	<b>BI</b>	Blanco	-
210089	Conector lineal interior con acometida/ Indoor lineal connector with feeder function/ Connecteur linéaire intérieure avec la fonction d'alimentation/ Conector linear interior com função de alimentador	<b>N</b>	Negro	-
204026	Tapa final/ End cap/ Capuchon/ Tapa final	<b>BI</b>	Blanco	-
210072	Tapa final/ End cap/ Capuchon/ Tapa final	<b>N</b>	Negro	-

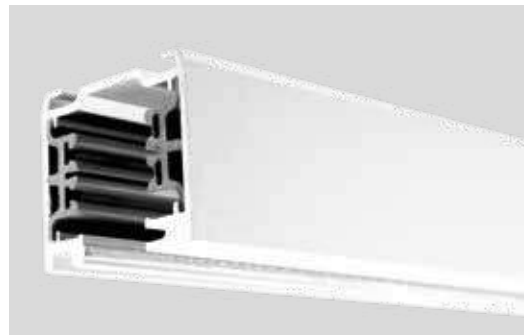
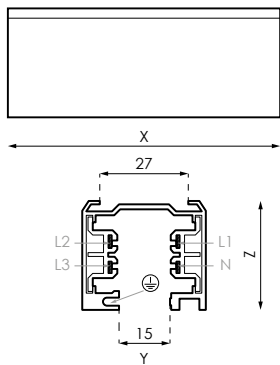

204002/210034/204019/210041/381734/381741



204071/210096



204057/210058



204033/210065



204064/210089

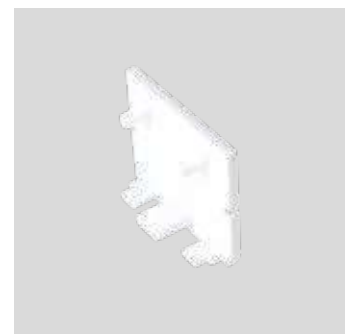

204026/210072





# Industrial





 **Hasta 5 años de garantía**  
**Up to 5 years of warranty**  
**Jusqu'à 5 ans de garantie**  
**Alé 5 anos de garantia**



Ñ/ El montaje del reflector y ópticas conlleva una reducción del flujo del 4%. Este producto se sirve con 2 mangueras incorporadas de 250mm.

E/ Reflector and optics mounting results in a 4% reduction in flow. This product is served with 2 built-in 250mm hoses.









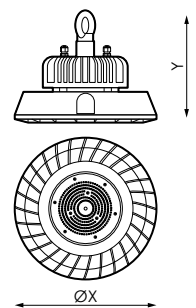

F/ L'écoulement de l'ensemble du réflecteur et optique conduit à une réduction de 4%. Ce produit est utilisé avec 2 tuyaux construits 250mm.

P/O conjunto reflector e óptica fluxo conduz a uma redução de 4%. Este produto é utilizado com 2 mangueiras construídas 250 mm.



	W <sub>LED</sub>	W <sub>T</sub>		φ <sub>LED</sub>	φ <sub>T</sub>	K	
468961	90W	100W	2A	13.996lm	13.118lm	<b>4</b>	4.000K Ø220 x 171,4mm
468978	90W	100W	2A	14.158lm	13.281lm	<b>5</b>	5.000K Ø220 x 171,4mm
468985	141W	150W	2,9A	21.158lm	19.815lm	<b>4</b>	4.000K Ø330 x 171,5mm
468992	141W	150W	2,9A	21.893lm	21.007lm	<b>5</b>	5.000K Ø330 x 171,5mm
469005	189W	200W	3,7A	27.936lm	26.089lm	<b>4</b>	4.000K Ø330 x 171,5mm
469012	189W	200W	3,7A	28.115lm	26.574lm	<b>5</b>	5.000K Ø330 x 171,5mm



	Hz	φ											
100-240V ac	50-60Hz	0,9	Cl	IP65	IK08	>80	-30°C~+35 °C	120°	(L70B50>) 50.000h	Negro	VT-T	AL	1-10V

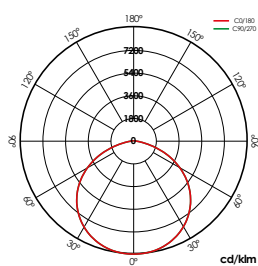

200W





BAJO PEDIDO / ON REQUEST / SUR COMMANDE / A PEDIDO



PC 50°

PC 90°

ACCESORIOS / ACCESSOIRES / ACCESSORIES / ACESSÓRIOS

+ INFO PAG. 232



469081

Reflector AL 100W 60°



469098

Reflector AL 150W/200W 60°



469104

Reflector PC 150W/200W 70°



469111

Rejilla seguridad 150W/200W



501149

Accesorio de suspensión para sensor sin reflector.



**N** 501521

Detector de movimiento. Hasta 15m de altura



**N** 507578

Control remoto detector de movimiento gran altura



Ñ/ El montaje del reflector y ópticas conlleva una reducción del flujo del 4%. Este producto se sirve con 2 mangueras incorporadas de 250mm.

E/ Reflector and optics mounting results in a 4% reduction in flow. This product is served with 2 built-in 250mm hoses.

F/ L'écoulement de l'ensemble du réflecteur et optique conduit à une réduction de 4%. Ce produit est utilisé avec 2 tuyaux construits 250mm.

P/ O conjunto refletor e óptica fluxo conduz a uma redução de 4%. Este produto é utilizado com 2 mangueiras construídas 250 mm.



Barcode	W <sub>LED</sub>	W <sub>T</sub>	Icon	φ <sub>LED</sub>	φ <sub>T</sub>	K	Icon
469388	92W	100W	2,28A	14.313lm	13.680lm	4	4.000K Ø300 x 167mm
469395	92W	100W	2,28A	14.877lm	13.985lm	5	5.000K Ø300 x 167mm
469401	138W	150W	3,57A	22.178lm	20.737lm	4	4.000K Ø300 x 167mm
469418	138W	150W	3,57A	22.597lm	21.034lm	5	5.000K Ø300 x 167mm
469425	186W	200W	4,76A	29.301lm	27.412lm	4	4.000K Ø360 x 189mm
469432	186W	200W	4,76A	29.808lm	28.019lm	5	5.000K Ø360 x 189mm

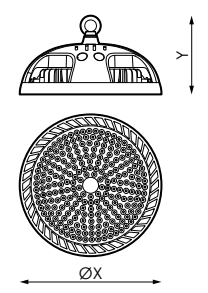

⚡	Hz	φ	⊕	⊖	✂	🌿	🔧	∠	📏	🔗	📄	🕒	
220-240V ac	50-60Hz	0,9	CI	IP65	IK10	>80	-30°C~+35 °C	120°	L70>50.000h	Negro	PC-T	AL	DALI

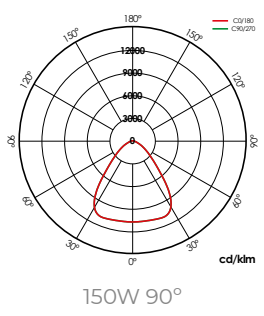



BAJO PEDIDO / ON REQUEST / SUR COMMANDE / A PEDIDO



**Bluetooth®**



PC 50°

PC 90°



**Kit de emergencia 2h (Excepto 200W)**

Emergency kit 2h (Except 200W)

Kit d'urgence 2h (Sauf 200W)

Kit de emergência 2h (Exceto 200W)

ACCESORIOS / ACCESSOIRES / ACCESSORIES / ACESSÓRIOS

+ INFO PAG. 232



469531

Kit lira 100W/150W



469548

Kit lira 200W



469449

Reflector AL negro 100W/150W  
90°



469456

Reflector AL negro 200W 90°



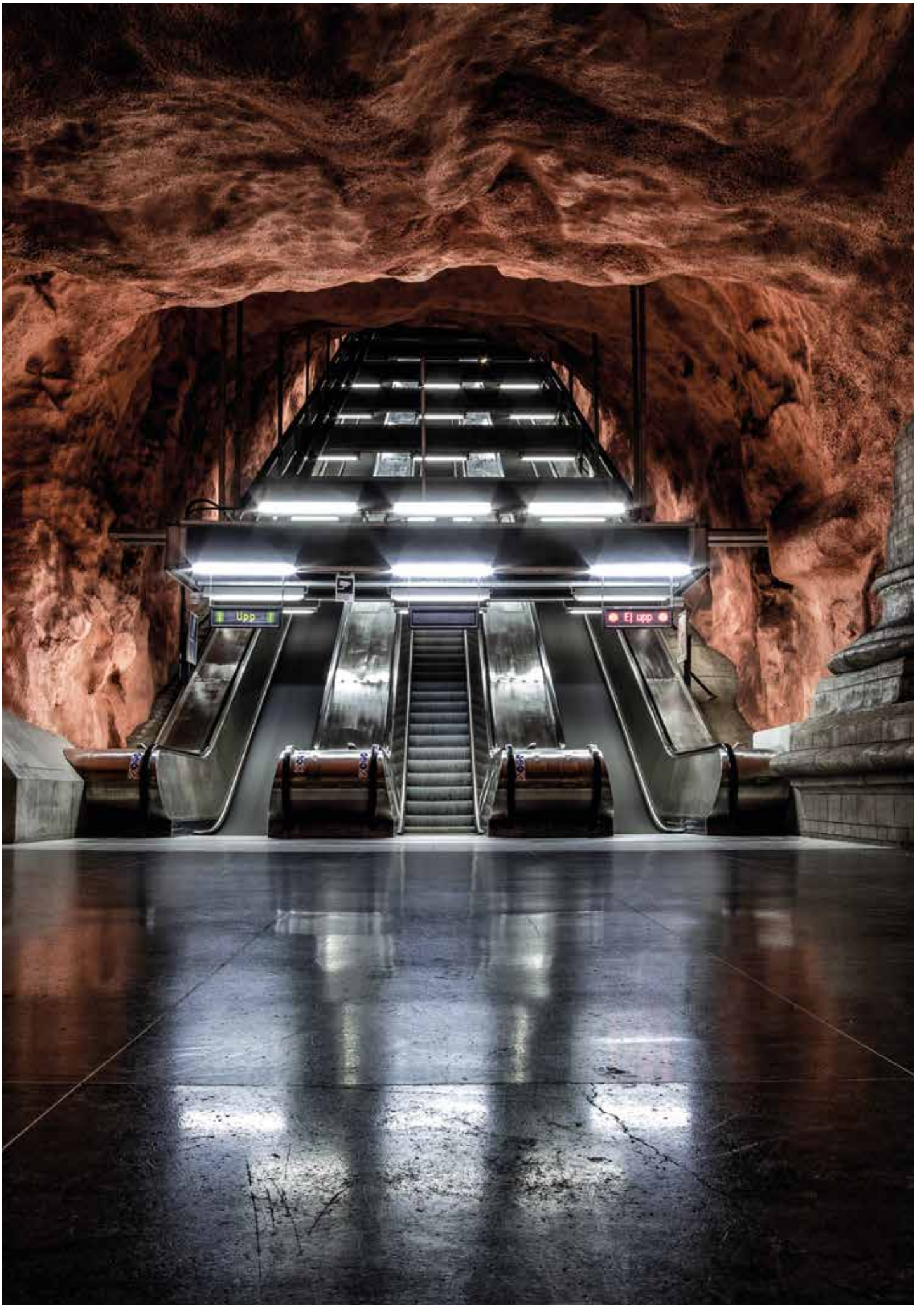

Ñ/ Clips para fácil apertura.  
Lámpara no incluido. E/ Clip for  
easy opening. Lamp not included.  
F/ Clip pour une ouverture  
facile. Lampe non incluse. P/  
Clipe para abertura fácil. Lâmpa-  
pada não incluída.

# Munich

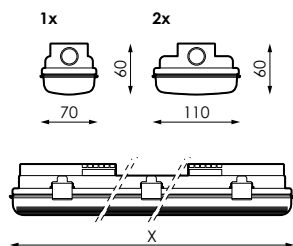

	W <sub>LED</sub>					
496018	1x	ecTUBE LED 600mm	Gr	Gris claro	668 x 70 x 60mm	6 clips 1
496025	1x	ecTUBE LED 1.200mm	Gr	Gris claro	1.278 x 70 x 60mm	10 clips 1
496032	1x	ecTUBE LED 1.500mm	Gr	Gris claro	1.578 x 70 x 60mm	12 clips 1
496049	2x	ecTUBE LED 600mm	Gr	Gris claro	668 x 110 x 60mm	6 clips 1
496056	2x	ecTUBE LED 1.200mm	Gr	Gris claro	1.278 x 110 x 60mm	10 clips 1
496063	2x	ecTUBE LED 1.500mm	Gr	Gris claro	1.578 x 110 x 60mm	12 clips 1
495950	1x	ecTUBE LED 600mm	Gr	Gris claro	668 x 70 x 60mm	6 clips 2
495967	1x	ecTUBE LED 1.200mm	Gr	Gris claro	1.278 x 70 x 60mm	10 clips 2
495974	1x	ecTUBE LED 1.500mm	Gr	Gris claro	1.578 x 70 x 60mm	12 clips 2
495981	2x	ecTUBE LED 600mm	Gr	Gris claro	668 x 110 x 60mm	6 clips 2
495998	2x	ecTUBE LED 1.200mm	Gr	Gris claro	1.278 x 110 x 60mm	10 clips 2
496001	2x	ecTUBE LED 1.500mm	Gr	Gris claro	1.578 x 110 x 60mm	12 clips 2

	Hz					
230V ac	50-60Hz	CI	IP65	-20°C~+35 °C	PC-T	PC

### ALIMENTACIÓN / POWER SUPPLY / SOURCE DE COURANT / FONTE DE ENERGÍA

Ñ/ Alimentación:  
1 Sin polaridad  
2 Con polaridad

F/ Source de courant:  
1 Sans polarité  
2 Avec polarité

E/ Power supply:  
1 Without polarity  
2 With polarity

P/ Fonte de energia:  
1 Sem polaridade  
2 Com polaridade

### ACCESORIOS / ACCESSOIRES / ACCESSORIES / ACESSÓRIOS

+ INFO PAG. 232

496131  
Kit 6 clips INOX 600mm

496148  
Kit 10 clips INOX 1.200mm

496155  
Kit 12 clips INOX 1.500mm



### INFORMACIÓN / INFORMATION / INFORMATION / INFORMAÇÕES

Ñ/ Hasta -20° con ecTUBE LED  
PRILUX BASIC y SMART.

E/ Up to -20° with ecTUBE LED  
PRILUX BASIC and SMART.

F/ Jusqu'à -20° avec ecTUBE  
LED PRILUX BASIC et SMART.

P/ Até -20° com ecTUBE LED  
PRILUX BASIC e SMART.









# Berlín *ECO*

Tubo Led

Ñ/ Clips para fácil apertura. Lámpara no incluido. E/ Clip for easy opening. Lamp not included. F/ Clip pour une ouverture facile. Lampe non incluse. P/ Clipe para abertura fácil. Lâmpada não incluída.



	Hz						
230V ac	50-60Hz	Cl	IP65	IK08	-20°C~+35 °C	PC-T	PC



Polideportivo El Zaburdón  
San Lorenzo de El Escorial (Madrid)

[GRÁFICOS: Unidades en mm/ GRAPHICS: Units in mm/ GRÁFICOS: Unidades en mm/ GRÁFICOS: Unidades em mm]

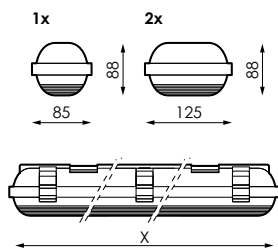

	$W_{LED}$						
469883	1x	ecTUBE LED 600mm	<b>Gr</b>	Gris claro	660 x 88 x 85mm	6 clips	1
469890	1x	ecTUBE LED 1.200mm	<b>Gr</b>	Gris claro	1.270 x 88 x 85mm	8 clips	1
469906	1x	ecTUBE LED 1.500mm	<b>Gr</b>	Gris claro	1.570 x 88 x 85mm	10 clips	1
469913	2x	ecTUBE LED 600mm	<b>Gr</b>	Gris claro	660 x 88 x 125mm	6 clips	1
469920	2x	ecTUBE LED 1.200mm	<b>Gr</b>	Gris claro	1.270 x 88 x 125mm	8 clips	1
469937	2x	ecTUBE LED 1.500mm	<b>Gr</b>	Gris claro	1.570 x 88 x 125mm	10 clips	1
469821	1x	ecTUBE LED 600mm	<b>Gr</b>	Gris claro	660 x 88 x 85mm	6 clips	2
469838	1x	ecTUBE LED 1.200mm	<b>Gr</b>	Gris claro	1.270 x 88 x 85mm	8 clips	2
469845	1x	ecTUBE LED 1.500mm	<b>Gr</b>	Gris claro	1.570 x 88 x 85mm	10 clips	2
469852	2x	ecTUBE LED 600mm	<b>Gr</b>	Gris claro	660 x 88 x 125mm	6 clips	2
469869	2x	ecTUBE LED 1.200mm	<b>Gr</b>	Gris claro	1.270 x 88 x 125mm	8 clips	2
469876	2x	ecTUBE LED 1.500mm	<b>Gr</b>	Gris claro	1.570 x 88 x 125mm	10 clips	2

#### ALIMENTACIÓN / POWER SUPPLY / SOURCE DE COURANT / FONTE DE ENERGÍA

Ñ/ Alimentación:  
1 Sin polaridad  
2 Con polaridad

F/ Source de courant:  
1 Sans polarité  
2 Avec polarité

E/ Power supply:  
1 Without polarity  
2 With polarity

P/ Fonte de energia:  
1 Sem polaridade  
2 Com polaridade

#### BAJO PEDIDO / ON REQUEST / SUR COMMANDE / A PEDIDO



Kit de emergencia 2h  
Emergency kit 2h  
Kit d'urgence 2h  
Kit de emergência 2h

#### ACCESORIOS / ACCESSOIRES / ACCESSORIES / ACESSÓRIOS

+ INFO PAG. 232

146340

Kit 8 clips INOX 1.200mm

146333

Kit 6 clips INOX 600mm

146357

Kit 10 clips INOX 1.500mm

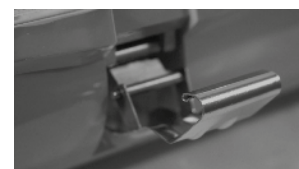

378376

Kit 8 clips plástico 1.200mm

378369

Kit 6 clips plástico 600mm

378406

Kit 10 clips plástico 1.500mm



#### INFORMACIÓN / INFORMATION / INFORMATION / INFORMAÇÕES

Ñ/ Hasta -20° con ecTUBE LED PRILUX BASIC y SMART.

E/ Up to -20° with ecTUBE LED PRILUX BASIC and SMART.

F/ Jusqu'à -20° avec ecTUBE LED PRILUX BASIC et SMART.

P/ Até -20° com ecTUBE LED PRILUX BASIC e SMART.

# Dácil



Barcode	W <sub>LED</sub>	W <sub>T</sub>	Φ <sub>LED</sub>	Φ <sub>T</sub>	K	Dimensions	Mounting
534499	18W	20W	2.943lm	2.414lm	4	4.000K 600 x 84 x 71mm	32
534505	18W	20W	3.090lm	2.533lm	6.5	6.500K 600 x 84 x 71mm	32
534512	37W	40W	5.421lm	4.418lm	4	4.000K 1.200 x 84 x 71mm	20
534529	37W	40W	5.637lm	4.623lm	6.5	6.500K 1.200 x 84 x 71mm	20
534536	57W	60W	7.965lm	6.534lm	4	4.000K 1.500 x 84 x 71mm	13
534543	57W	60W	8.364lm	6.858lm	6.5	6.500K 1.500 x 84 x 71mm	13

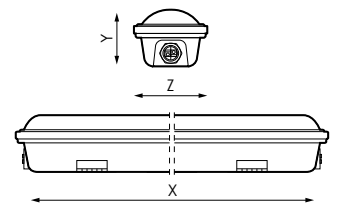

⚡	Hz	Φ	□	○	✂	⌚	🌿	🕒	⊗	📏	📄	↑
230V ac	50-60Hz	0.9	CII	IP65	IK07	-10°C~+35°C	>80	(L70B50>) 30.000h	BL	PC-O	PC	SUPERFICIE

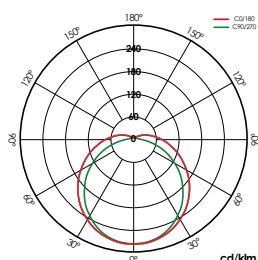

18W 600mm

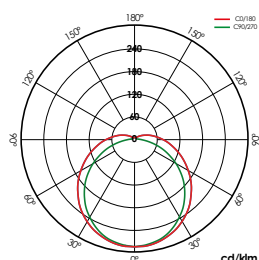

37W 1.200mm

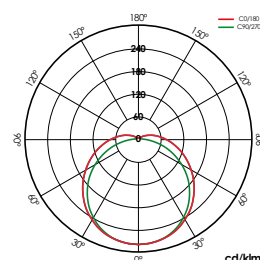

57W 1.500mm

## INFORMACIÓN / INFORMATION / INFORMATION / INFORMAÇÕES

Ñ/ Conector rápido.  
Clip de fijación.  
Conexión en serie:  
18W: 32luminarias  
37W: 20luminarias  
57W: 13luminarias

E/ Quick connector.  
Fastening clip.  
Serial connection:  
18W: 32luminaires  
37W: 20luminaires  
57W: 13luminaires

F/ Connecteur rapide.  
Clip de montage.  
Connexion en série:  
18W: 32luminaires  
37W: 20luminaires  
57W: 13luminaires

P/ Conector Quick.  
Clipe de montagem.  
Ligação em série:  
18W: 32luminarias  
37W: 20luminarias  
57W: 13luminarias

## AVISO / WARNING / AVERTISSEMENT / AVISO

Ñ/ No apto para su exposición a rayos uva.

E/ Not suitable for your exposure to uva rays.

F/ Non adapté à votre exposition aux rayons uva.

P/ Não adequado para a sua exposição para raios uva.

# Dácil Switch

Con selector de t° de color a través de interruptor  
With t° color selector through switch  
Avec sélecteur t° de couleur par commutateur  
Com o seletor de cores através da chave

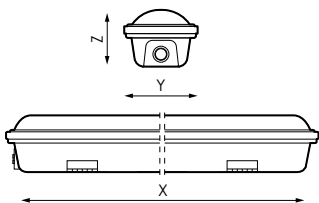

	W <sub>LED</sub>	W <sub>T</sub>	Φ <sub>LED</sub>	Φ <sub>T</sub>	K	
521031	18W	20W	2.943lm	2.414lm	<b>4</b> 4.000K	600 x 84 x 71mm
			3.090lm	2.533lm	<b>6.5</b> 6.500K	
521048	37W	40W	5.421lm	4.418lm	<b>4</b> 4.000K	1.200 x 84 x 71mm
			5.637lm	4.623lm	<b>6.5</b> 6.500K	
521055	57W	60W	7.965lm	6.534lm	<b>4</b> 4.000K	1.500 x 84 x 71mm
			8.364lm	6.858lm	<b>6.5</b> 6.500K	

230V ac	50-60Hz	0.9	CII	IP65	IK07	-10°C~+35°C	>80	(L70B50>) 50.000h	BL	PC-O	PC	SUPERFICIE	DALI

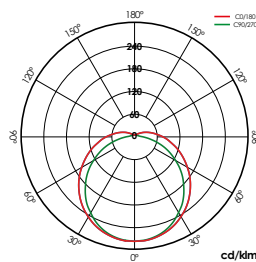

18W 600mm

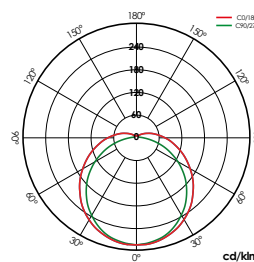

37W 1.200mm

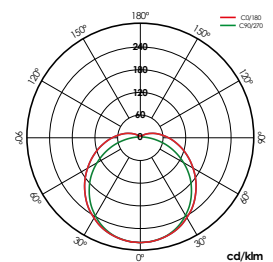

57W 1.500mm

## AVISO / WARNING / AVERTISSEMENT / AVISO

Ñ/ No apto para su exposición a rayos uva.

E/ Not suitable for your exposure to uva rays.

F/ Non adapté à votre exposition aux rayons uva.

P/ Não adequado para a sua exposição para raios uva.

## INFORMACIÓN / INFORMATION / INFORMATION / INFORMAÇÕES

Ñ/ Conector rápido.

F/ Connecteur rapide.

E/ Quick connector.

P/ Conector rápido.



# Dácil Switch

## Emergencia



Con selector de t° de color a través de interruptor  
 With t° color selector through switch  
 Avec sélecteur t° de couleur par commutateur  
 Com o seletor de cores através da chave



Barcode	W <sub>LED</sub>	W <sub>T</sub>	Φ <sub>LED</sub>	Φ <sub>T</sub>	K	Dimensions						
5766673	37W	40W	5.421lm 5.637lm	4.418lm 4.623lm	4 6.5	4.000K 6.500K	1.200 x 84 x 71mm					
⚡	Hz	φ	□	⊙	⚡	⌚	⌚	⌚	⌚	⌚	⌚	⌚
230V ac	50-60Hz	0.9	CII	IP65	IK07	-10°C~+35°C	>80	(L70B50>) 50,000h	BL	PC-O	PC	SUPERFICIE

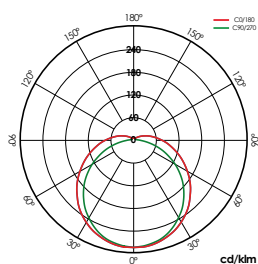
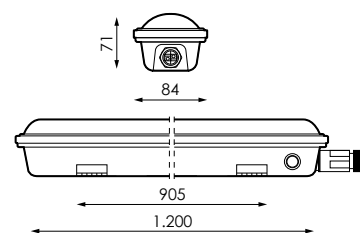

37W 1.200mm

### AVISO / WARNING / AVERTISSEMENT / AVISO

Ñ/ No apto para su exposición a rayos uva.

E/ Not suitable for your exposure to uva rays.

F/ Non adapté à votre exposition aux rayons uva.

P/ Não adequado para a sua exposição para raios uva.

### INFORMACIÓN / INFORMATION / INFORMATION / INFORMAÇÕES



Ñ/ Kit emergencia de 1,5h de 10W.

F/ Kit d'urgence 1,5h 10W.

E/ 1,5h 10W emergency kit.

P/ 1,5h 10W kit de emergência.



**Pantalla estanca de alta resistencia**  
High resistance waterproof screen  
Ecran étanche haute résistance  
Tela impermeável de alta resistência

**IP66**

**IK10**

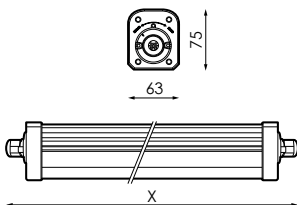

	W <sub>LED</sub>	W <sub>T</sub>	φ <sub>LED</sub>	φ <sub>T</sub>	K		
560511	17W	20W	2.842mm	2.477mm	4	4.000K	608 x 63 x 75mm
560535	17W	20W	2.842mm	2.477mm	5	5.000K	608 x 63 x 75mm
560542	32W	36W	5.531mm	4.811mm	4	4.000K	1.208 x 63 x 75mm
560566	32W	36W	5.531mm	4.811mm	5	5.000K	1.208 x 63 x 75mm
560573	47W	50W	6.651mm	5.793mm	4	4.000K	1.508 x 63 x 75mm
560580	47W	50W	6.651mm	5.793mm	5	5.000K	1.508 x 63 x 75mm

100-240V	50-60Hz	CII	IP66	IK10	-20°C~+35°C	>80 (L70B50>) 50,000h	BL	PC	PC-O	SUPERFICIE

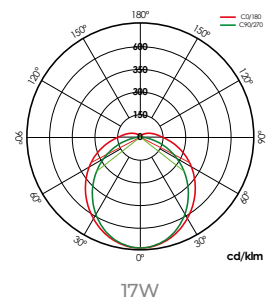

## INFORMACIÓN / INFORMATION / INFORMATION / INFORMAÇÕES

**Ñ/** Conector rápido.  
Clip de fijación.  
Conexión en serie:  
17W: 32luminarias  
32W: 20luminarias  
47W: 13luminarias

**E/** Quick connector.  
Fastening clip.  
Serial connection:  
17W: 32luminaires  
32W: 20luminaires  
47W: 13luminaires

**F/** Connecteur rapide.  
Clip de montage.  
Connexion en série:  
17W: 32luminaires  
32W: 20luminaires  
47W: 13luminaires

**P/** Conector Quick.  
Clipes de montagem.  
Ligação em série:  
17W: 32luminarias  
32W: 20luminarias  
47W: 13luminarias

## AVISO / WARNING / AVERTISSEMENT / AVISO

**Ñ/** No apto para su exposición a rayos uva.

**E/** Not suitable for your exposure to uva rays.

**F/** Non adapté à votre exposition aux rayons uva.

**P/** Não adequado para a sua exposição para raios uva.

# Accesorios

Accessories

Accessoires

Acessórios

Icon	Part Number	Munich			Berlin Eco Tubo LED IP65			Aken		Kela	
		600mm	1200mm	1.500mm	600mm	1.200mm	1.500mm	100W	150W/200W	100W/150W	200W
⌋○	146333				•						
	146340					•					
	146357						•				
	378369				•						
	378376					•					
	378406						•				
	496131	•									
	496148		•								
	496155			•							
⊠	469081							•			
	469098								•		
	469104								•		
	469111								•		
	469449									•	
	469456										•
⌋○	469531									•	
	469548										•
⌋⊠	501149							•	•		
	501521							•	•		
	507578							•	•		



## N 501521

Detector de movimiento.  
Válido para grandes alturas (hasta 15m) 2/3 niveles 1-10V.  
Movement detector.  
Valid for high altitudes (up to 15m) 2/3 levels 1-10V.  
Décteur de mouvement.  
Valable pour les hautes altitudes (jusqu'à 15m) 2/3 niveaux 1-10V.  
Detector de movimento.  
Válido para altas altitudes (até 15m) 2/3 níveis 1-10V.



## 501149

Accesorio de sujeción para el montaje del sensor sin reflector Aken.  
Fixing attachment for sensor mounting without reflector Aken.  
Fixture pour le montage du capteur sans réflecteur Aken.  
Fixação para montagem no sensor sem reflector Aken.



## N 507578

Control remoto para el detector de movimiento de grandes alturas.  
Remote control for high-rise motion detector.  
Télécommande pour détecteur de mouvement de grande hauteur.  
Control remoto para detector de movimento de arranha-céus.



469081

Reflector Aluminio 100W 60°  
Aluminum Reflector 100W 60°  
Réflecteur Aluminium 100W 60°  
Reflektor Aluminio 100W 60°



469098

Reflector Aluminio 150W/200W 60°  
Aluminum Reflector 150W/200W 60°  
Réflecteur Aluminium 150W/200W 60°  
Reflektor Aluminio 150W/200W 60°



469104

Reflector PC 150W/200W 70°  
PC Reflector 150W/200W 70°  
Réflecteur PC 150W/200W 70°  
Reflektor PC 150W/200W 70°



469111

Rejilla seguridad 150W/200W  
Security grid 150W/200W  
Grille de sécurité 150W/200W  
Grade de segurança 150W/200W



469531

Kit lira 100W/150W  
Bracket kit 100W/150W  
Kit support 100W/150W  
Kit suporte 100W/150W



469548

Kit lira 200W  
Bracket kit 200W  
Kit support 200W  
Kit suporte 200W



469449

Reflector Aluminio negro 100W/150W 90°  
Alumimun black reflector 100W/150W 90°  
Réflecteur aluminium noir 100W/150W 90°  
Reflektor preto de alumínio 100W/150W 90°



469456

Reflector Aluminio negro 200W 90°  
Alumimun black reflector 200W 90°  
Réflecteur aluminium noir 200W 90°  
Reflektor preto de alumínio 200W 90°



496131

Kit 6 clips plástico 600mm  
Kit 6 plastic clips 600mm  
Kit 6 clips en plastique 600mm  
Kit 6 cliques de plástico de 600mm



496148

Kit 10 clips plástico 1.200mm  
Kit 10 plastic clips 1.200mm  
Kit 10 clips en plastique 1.200mm  
Kit 10 cliques de plástico de 1.200mm



496155

Kit 12 clips plástico 1.500mm  
Kit 12 plastic clips 1.500mm  
Kit 12 clips en plastique 1.500mm  
Kit 12 cliques de plástico de 1.500mm



378369

Kit 6 clips plástico 600mm  
Kit 6 plastic clips 600mm  
Kit 6 clips en plastique 600mm  
Kit 6 cliques de plástico de 600mm



378376

Kit 8 clips plástico 1.200mm  
Kit 8 plastic clips 1.200mm  
Kit 8 clips en plastique 1.200mm  
Kit 8 cliques de plástico de 1.200mm



378406

Kit 10 clips plástico 1.500mm  
Kit 10 plastic clips 1.500mm  
Kit 10 clips en plastique 1.500mm  
Kit 10 cliques de plástico de 1.500mm



146333

Kit 6 clips metálicos INOX 600mm  
Kit 6 stainless steel clips 600mm  
Kit 6 clips en acier INOX 600mm  
Kit 6 cliques de aço INOX de 600mm



146340

Kit 8 clips metálicos INOX 1.200mm  
Kit 8 stainless steel clips 1.200mm  
Kit 8 clips en acier INOX 1.200mm  
Kit 8 cliques de aço INOX de 1.200mm



146357

Kit 10 clips metálicos INOX 1.500mm  
Kit 10 stainless steel clips 1.500mm  
Kit 10 clips en acier INOX 1.500mm  
Kit 10 cliques de aço INOX de 1.500mm

Handwritten notes and tables on a grey sheet of paper.

Table 1 (top left):

1	2	3	4	5	6	7	8	9	10
11	12	13	14	15	16	17	18	19	20
21	22	23	24	25	26	27	28	29	30
31	32	33	34	35	36	37	38	39	40
41	42	43	44	45	46	47	48	49	50
51	52	53	54	55	56	57	58	59	60
61	62	63	64	65	66	67	68	69	70
71	72	73	74	75	76	77	78	79	80
81	82	83	84	85	86	87	88	89	90
91	92	93	94	95	96	97	98	99	100

Table 2 (top middle):

1	2	3	4	5	6	7	8	9	10
11	12	13	14	15	16	17	18	19	20
21	22	23	24	25	26	27	28	29	30
31	32	33	34	35	36	37	38	39	40
41	42	43	44	45	46	47	48	49	50
51	52	53	54	55	56	57	58	59	60
61	62	63	64	65	66	67	68	69	70
71	72	73	74	75	76	77	78	79	80
81	82	83	84	85	86	87	88	89	90
91	92	93	94	95	96	97	98	99	100

Table 3 (top right):

1	2	3	4	5	6	7	8	9	10
11	12	13	14	15	16	17	18	19	20
21	22	23	24	25	26	27	28	29	30
31	32	33	34	35	36	37	38	39	40
41	42	43	44	45	46	47	48	49	50
51	52	53	54	55	56	57	58	59	60
61	62	63	64	65	66	67	68	69	70
71	72	73	74	75	76	77	78	79	80
81	82	83	84	85	86	87	88	89	90
91	92	93	94	95	96	97	98	99	100



Table with multiple columns and rows of data, possibly a ledger or account book.

1	2	3	4	5	6	7	8	9	10
11	12	13	14	15	16	17	18	19	20
21	22	23	24	25	26	27	28	29	30
31	32	33	34	35	36	37	38	39	40
41	42	43	44	45	46	47	48	49	50
51	52	53	54	55	56	57	58	59	60
61	62	63	64	65	66	67	68	69	70
71	72	73	74	75	76	77	78	79	80
81	82	83	84	85	86	87	88	89	90
91	92	93	94	95	96	97	98	99	100

Table with multiple columns and rows of data, possibly a ledger or account book.

1	2	3	4	5	6	7	8	9	10
11	12	13	14	15	16	17	18	19	20
21	22	23	24	25	26	27	28	29	30
31	32	33	34	35	36	37	38	39	40
41	42	43	44	45	46	47	48	49	50
51	52	53	54	55	56	57	58	59	60
61	62	63	64	65	66	67	68	69	70
71	72	73	74	75	76	77	78	79	80
81	82	83	84	85	86	87	88	89	90
91	92	93	94	95	96	97	98	99	100



Anexos  
Annexes  
Annexes  
Anexos





## Certificaciones

Certifications  
Certifications  
Certificações



SGS ISO 9001



SGS ISO 14001



SGS ISO 45001



SGS ISO 50001

## Condiciones de Uso

Terms of use  
Condition d'utilisation  
Condições de uso



## Condiciones de Garantía



Warranty Conditions  
Conditions de garantie  
Condições de garantia



























## Condiciones de Venta

Terms of sale  
Conditions de vente  
Condições de venda



	ESPAÑOL (Ñ)	ENGLISH (E)	FRANÇAIS (F)	PORTUGUÊS (P)
	Código	Code	Code	Código
	CEE Clasificación energética	CEE Energy classification	CEE Classification énergétique	CEE Classificação energética
	Potencia LED (W)	Power LED (W)	Puissance LED (W)	Potência LED (W)
	Potencia Total (W)	Total Power (W)	Puissance Total (W)	Potência Total (W)
	Modelo	Model	Modèle	Modelo
	Niveles lumínicos	Light levels	Niveaux de lumière	Níveis de luz
	Tensión (V)	Voltage (V)	Tension D` Alimentation (V)	Tensão (V)
<b>Hz</b>	Frecuencia (Hz)	Frequency (Hz)	Fréquence (Hz)	Frequência (Hz)
	Intensidad (A)	Current (A)	Intensité (A)	Intensidade (A)
	Factor de potencia (Cosφ)	Power factor (Cosφ)	Facteur de puissance (Cosφ)	Fator de Potência (Cosφ)
	Clase I Aislamiento eléctrico	Class I Electrical isolation	Classe I Isolation électrique	Clase I Isolamento elétrico
	Clase II Aislamiento eléctrico	Class II Electrical isolation	Classe II Isolation électrique	Clase II Isolamento elétrico
	Clase III Aislamiento eléctrico	Class III Electrical isolation	Classe III Isolation électrique	Clase III Isolamento elétrico
	IP Índice de estanqueidad	IP Sealing rating	IP Indice d` étanchéité	IP Índice de selagem
	IP luminaria Índice de estanqueidad	IP luminaire Sealing rating	IP luminaire Indice d` étanchéité	IP luminaria Índice de selagem
	IP instalado Índice de estanqueidad	Ip installed Sealing rating	IP installé Indice d` étanchéité	IP instalado Índice de selagem
	IK Protección contra impactos	IK Impact resistance	IK Protection contre des impacts	IK Proteção contra impactos
	Temperatura de funcionamiento	Operating temperature	Température de service	Temperatura de trabalho
	Flujo Luminoso de LED (lm)	Flux LED (lm)	Flux LED (lm)	Fluxo LED (lm)
	Flujo Luminoso Total (lm)	Total Flux (lm)	Flux Total (lm)	Fluxo Total (lm)
	Ángulo de apertura	Opening angle	Angle d` ouverture	Ângulo de abertura
	Óptica	Optical	Optique	Óptica
<b>K</b>	Temperatura de color	Colour temperature	Température de couleur	Temperatura de cor
	CRI Índice de reproducción cromática	CRI Colour rendering index	CRI Indice de rendu des couleurs	CRI Índice de reprodução cromática
	UGR	UGR	UGR	UGR
	Número de led	LED number	Nombre de led	Número de led
	Leds/m	Leds/m	Leds/m	Leds/m
	Fuente de luz	Light source	Source de lumière	Fonte de luz
	Casquillo	Cap	Culot	Base
	Nº de Encendidos	Nº of ignitions	Nº d`allumages	Nº de ignições
	Vida útil	Lifetime	Heures de vie	Vida

	ESPAÑOL (Ñ)	ENGLISH (E)	FRANÇAIS (F)	PORTUGUÊS (P)
	Color	Colour	Couleur	Cor
	Carga estática	Static load	Static charge	Carga estática
	Dimensiones	Measures	Dimensions	Dimensão
	Cuerpo	Body	Corps	Corpo
	Difusor	Diffuser	Diffuseur	Difusor
	Reflector	Reflector	Réflecteur	Refletor
	Marco	Frame	Cadre	Quadro
	Corte	Cutting	Coupe	Corte
	Corte tira	Strip cutting	Coupe bande	Corte tira
	Anclaje	Anchorage	Ancre	Âncora
	Tapa inicio/Tapa final	Start cover / End cover	Capot de début / Capot de fin	Tampa inicial / Tampa final
	Rollo	Roll	Rouleau	Rolo
	Luminaria de empotrar	Recessed luminaire	Luminaire encastré	Luminária de encastrar
	Luminaria de superficie	Surface luminaire	Luminaire de surface	Luminária de superfície
	Luminaria de suspender	Suspension luminaire	Suspension luminaire	Luminária de suspensão
	Giro de la luminaria	Turn of the luminaire	Tour du luminaire	Orientação da luminária
	Empalmable	Linkable	Empalmable	Junção
	Regulable	Dimmable	Dimmable	Regulável
	Configuración	Configuration	Configuration	Configuração
	Sensor	Sensor	Capteur	Sensor
	Control	Control	Contrôle	Controla
	Unión	Union	Union	União
	Cierre	Locking	Fermer	Fechar
	Vísera	Víser	Visière	Víseira
	Protección	Protection	Protection	Proteção
	Alimentación	Power supply	Source de courant	Fonte de energia
	Alimentación no incluida	Power supply not included	Source de courant Non inclus	Fonte de energia Não incluso
	Accesorios	Accessories	Accessoires	Acessórios
	Montaje	Mounting	Assemblage	Assembléia
	Aviso	Notice	Avis	Aviso
	Vídeo demostrativo	Demonstration video	Vídeo de démonstration	Vídeo de demonstração

## Regulación

Dimming  
Dimmable  
Regulável

	ESPAÑOL (Ñ)	ENGLISH (E)	FRANÇAIS (F)	PORTUGUÊS (P)
1-10V	Regulación 1-10V	Dimmable 1-10V	Dimmable 1-10V	Dimerizável 1-10V
DALI	Dali	Dali	Dali	Dali
CTOUCH	Control Touch	Control Touch	Control Touch	Control Touch

## Cuerpo

Body  
Corps  
Corpo

	ESPAÑOL (Ñ)	ENGLISH (E)	FRANÇAIS (F)	PORTUGUÊS (P)
AL	Aluminio	Aluminum	Aluminum	Alumínio
Z	Zamak	Zamak	Zamak	Zamak
FE	Acero	Steel	Acier	Aço
INOX	Inox	Stainless	Inoxydable	Inoxidável
FE INOX	Acero Inox	Stainless steel	Acier Inoxydable	Aço Inoxidável
TP	Termoplástico	Thermoplastic	Thermoplastique	Termoplástico
PC	Polícarbonato	Polycarbonate	Polycarbonate	Polícarbonato
PVC	PVC	PVC	PVC	PVC
ABS	Plástico ABS	Plastic ABS	Plastique ABS	Plástico ABS
PET	Politereftalato de etileno	Ethylene polyterephthalate	Polytérephtalate d'éthylène	Polieterftalato de etileno

## Difusor

Diffuser  
Diffuseur  
Difusor

	ESPAÑOL (Ñ)	ENGLISH (E)	FRANÇAIS (F)	PORTUGUÊS (P)
VT-T	Vidrio Templado transparente	Transparent Tempered glass	Verre trempé transparent	Vidro temperado transparente
VT-O	Vidrio Templado opal	Opal Tempered glass	Verre trempé opale	Vidro temperado opal
VT-O PET	Vidrio Templado opal con recubrimiento PET	Opal Tempered glass with PET coating	Verre trempé opale avec revêtement PET	Vidro temperado opal com revestimento PET
VT-P	Vidrio prismático	Prismatic glass	Verre prismatique	Vidro prismático
PMMA-O	Polimetilmetacrilato opal	Opal Polymethylmethacrylate	Polyméthacrylate de méthyle opale	Polimetilmetacrilato opal
PMMA-P	PMMA prismático	Prismatic polymethylmethacrylate	Polyméthacrylate de méthyle prismatique	Polimetilmetacrilato prismático
PC-T	Polícarbonato transparente	Transparent Polycarbonate	Polycarbonate transparent	Polícarbonato transparente
PC-O	Polícarbonato opal	Opal polycarbonate	Polycarbonate opale	Polícarbonato opal
PC-P	Polícarbonato prismático	Prismatic Polycarbonate	Polycarbonate prismatique	Polícarbonato prismático
PS	Poliestireno	Polystyrene	Polystyrène	Poliestireno



Regulación DALI  
DALI Dimming  
Atténuation DALI  
Regulação DALI



Compatible BLUETOOTH  
BLUETOOTH Compatible  
Compatible BLUETOOTH  
Compatível BLUETOOTH





## GRUPO PRILUX ILUMINACIÓN S.L.U.

### SEDE CENTRAL

C/ Río Jarama nº 149.45007, Toledo (Spain).  
Tel.: 925 23 38 12 / Fax: 925 23 38 80

### DELEGACIÓN NORESTE

Carretera BV - 2249 Km 8  
08791, Sant Llorenç d'Hortons, Barcelona (Spain).

**Prilux eConcept** Tel.: (+34) 93 891 37 24

**Grupo Prilux Iluminación S.L.U** Tel: (+34) 93 719 23 29

[www.grupoprilux.com](http://www.grupoprilux.com)

### IMPRESIÓN

Febrero 2022

### DISEÑO GRÁFICO

Departamento de Marketing

Pueden aparecer variaciones con respecto al color original debido a causas técnicas de la impresión.

Este catálogo actualiza los valores y características de las mismas luminarias que aparezcan en anteriores catálogos.

Los datos incluidos en este catálogo son correctos salvo error tipográfico.

Grupo Prilux Iluminación S.L.U. se reserva el derecho a cualquier modificación del producto sin previo aviso.

Web



Tarifa  
Price list  
Liste de prix  
Lista de preços



