

# eConcept

T É C N I C O





# eConcept

T É C N I C O



# motivos

motif/motifs/motives



Colección Shinning 26

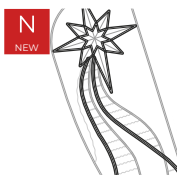

Colección Chasing 32

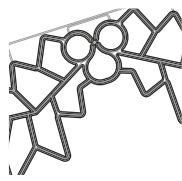

Colección Straight 36

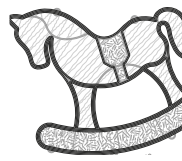

Colección Toy 50



Colección Curly 60

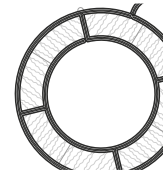

Colección Fantasy 72

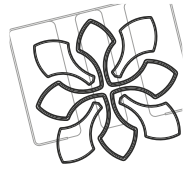

Colección Edén 80

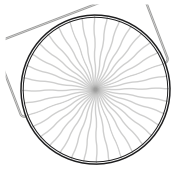

Colección Helix 84



Letreros Corpóreos 90



Letreros 93

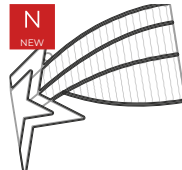

Calle 114



Farola, Calle y Fachada 129

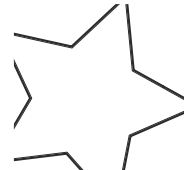

Mini 165



Accesorios 175



3D 176

# Sistemas dinámicos

Dynamic systems/Systèmes dynamiques/Sistemas dinàmicos

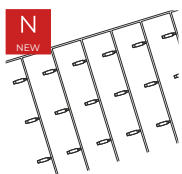

Screenlight Smart 260

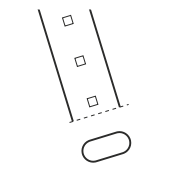

Flexilight Maxibrillo RGB 262



Flexilight Double Neon RGB 263

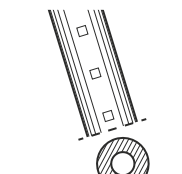

Flexilight RGBWW 264

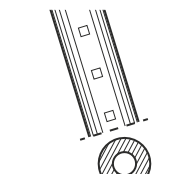

Flexilight RGB 265

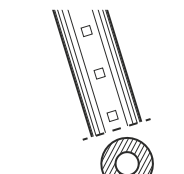

Flexilight CW-WW 266

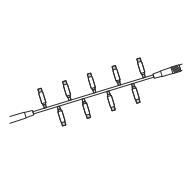

String Plus 100 RGBWW 267

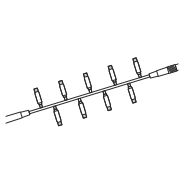

String Plus 100 RGB 268

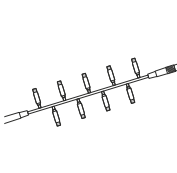

String Plus 100 CW-WW 269

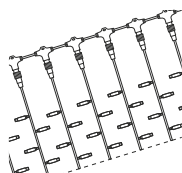

Screenlight RGBWW 270

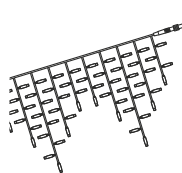

Icicle RGBWW 271

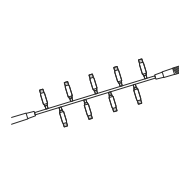

String Plus 100 24V Transform. 274

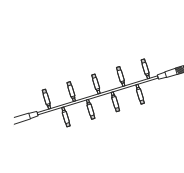

String Plus 100 24V Fuente ali. 276

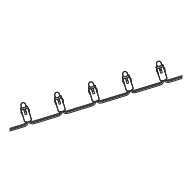

String PIXELMAX 280

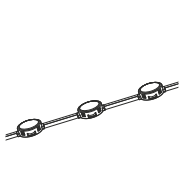

Dot DMX PIXELMAX 284

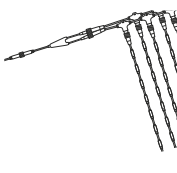

Screen PIXELMAX 286

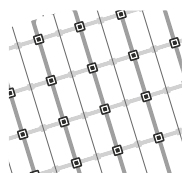

Mesh PIXELMAX 288



Accesorios 292

# Flexilight

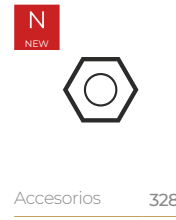
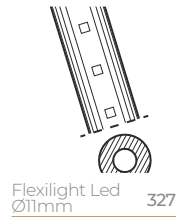
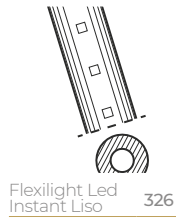
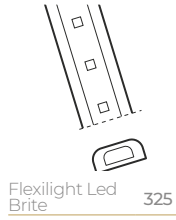
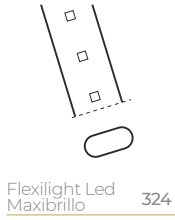
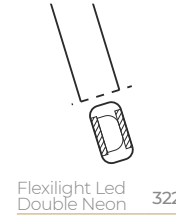
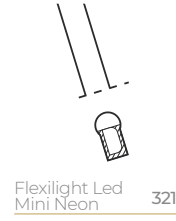
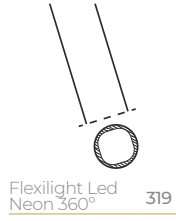
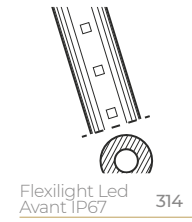
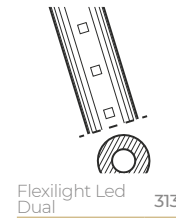
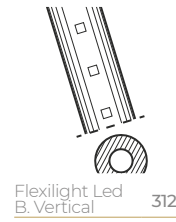
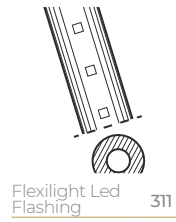
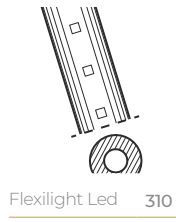
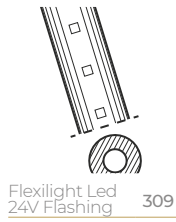
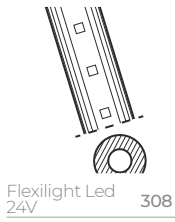

# minimalist

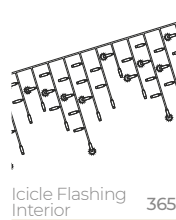
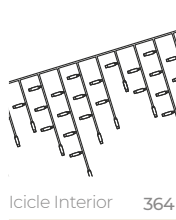
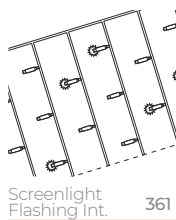
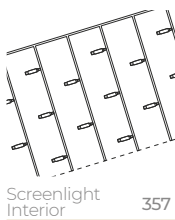
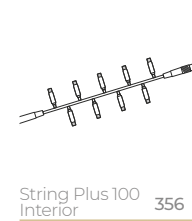
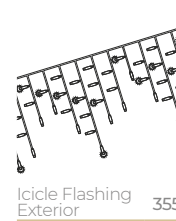
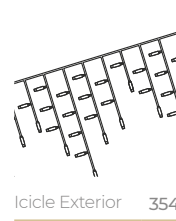
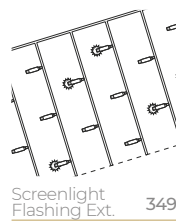
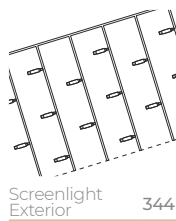
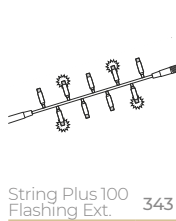
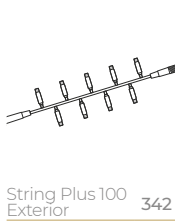

# Led Exterior

Outdoors Led/Led à l'exterieur/Led ao ar livre

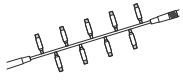

String Avant IP67 370

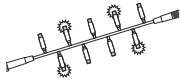

String Avant Flashing IP67 371

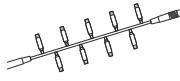

String Plus 180 24V fuente al. 372

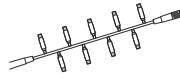

String Plus 180 24V transf. 374

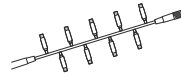

String Plus 180 1seccion 375

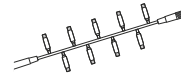

String Plus 180 376

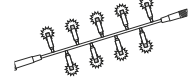

String Plus 120 ALL Flashing 378

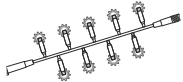

String Plus 180 Sparkle 379

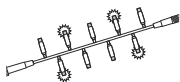

String Plus 180 Flashing 380

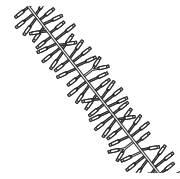

Cluster Light Fall Lite 382

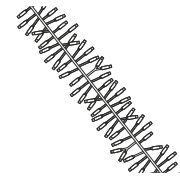

Cluster Light Flashing 384

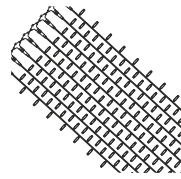

Techo Luz Screen-light Flash 385

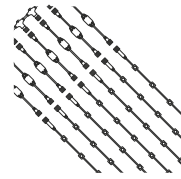

Techo Luz 386

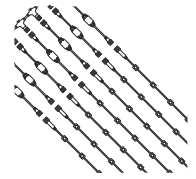

Techo Luz Flashing 387

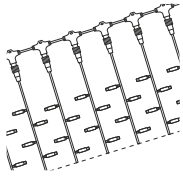

Screenlight 24V 388

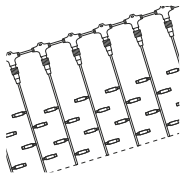

Screenlight 390

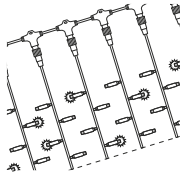

Screenlight Flashing 394

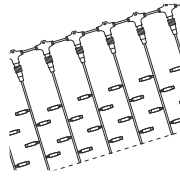

Screenlight Dual 398

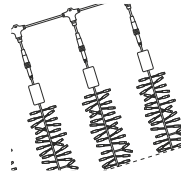

Screenlight 250 Fall Lite 400

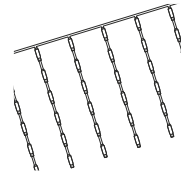

Screen Rain 401

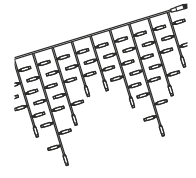

Icicle 402

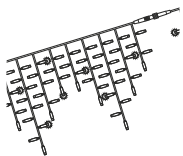

Icicle Flashing 405

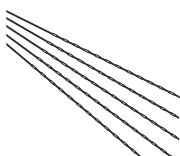

Cascada 408

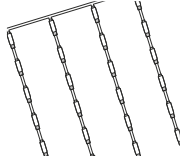

Screenlight Cascada 410

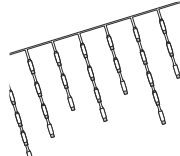

Icicle Cascada 411

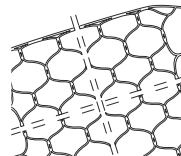

Red 24V 413

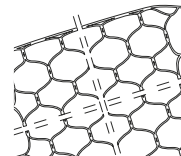

Red 414

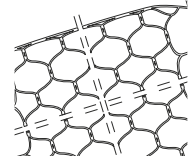

Red Flashing 416



Accesorios 418

# Led Interior

Indoors Led/Led à l'interieur/Led interior

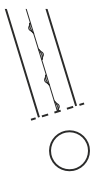

Flexilight Ø7mm 429

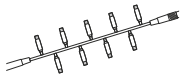

String Plus 180 430

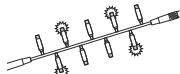

String Plus 180 Flashing 431

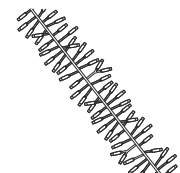

Cluster Light Fall Lite 432

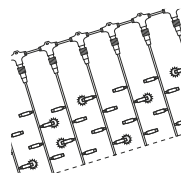

Screenlight Flashing 434

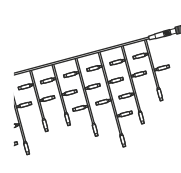

Icicle 436



Accesorios 438

|   |   |   |   |  |   |   |
|---|---|---|---|--|---|---|
|     |    |    |    |    |    |    |
| Cluster Microled 442  | Branch String 443   | Branch Tree 444   | Solar String 445  | LED Fireworks 446  | Giro Snowflake 447  | Nesso 448   |
|     |    |    |    |    |    |    |
| Nesso Steady 450  | Willow Light 452  | LED Fountain 454  | Deco Branch 455   | Branch LED 456   | Spiral 457  | Snow Tree 458   |
|   |   |   |   |   |   |   |
| Golden Tree 459   | Willow Tree 460   | Birch Tree 461  | Birch Forest Tree 462   | Winter Tree 463  | Christmas Tree 464  | Star Gold Line 3D 467   |
|   |  |  |  |  |  |  |
| Star Flat 468   | Star Copper 468   | Star Glass Balls 469  | Cluster Glass Balls 469   | Cotton Balls 470   | Glass Balls Chain 471   | esSense Plastic Balls 471   |
|   |  |  |  |  |  |  |
| Spike Star 472  | Glitter Star 472  | Glitter Loop 473  | Candy Cane 473  | Ocean Comet 474  | Ocean Star 474  | Ocean Cone 475  |
|  |  |  |  |  |  |  |
| Elegant Cone 476  | Elegant Deer 477  | Elegant Deer Set 479  | Elegant Gift 480  | Elegant Box 480  | Elegant Fox 481   | Farol 481   |
|  |  |  |  |  |  |  |
| Glacier Deer 482  | Glacier Deer Set 483  | Christmas Balls 484   | Cluster Balls 487   | Branch 488   | Tapiz 489   | Garland 490   |

# deco

N  
NEW



Holly Garland 491

N  
NEW



Pine Garland 491

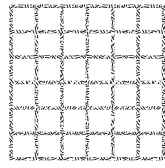

Tapiz NET 492

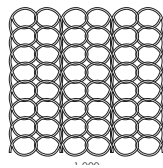

PVC NET 493

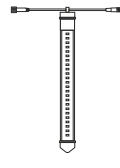

Fall Lite Led Smart 494



Fall Lite LED 496

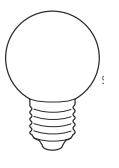

Lámparas LED 497

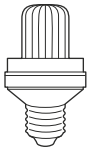

Flash Light LED 499

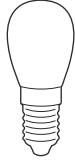

Lámparas Incandescencia 499

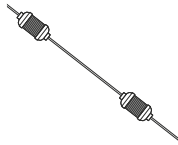

String Flash 500

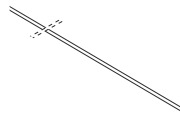

Stalactite Garland 502

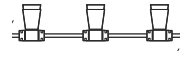

Guirnalda E14/E27 504



Accesorios 506

# Anexos

Annexes/Annexes/Anexos

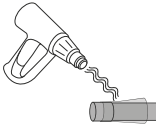

Guía Mantenimiento 510

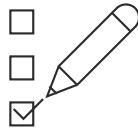

Certificaciones 514



Condiciones de Uso 514



Condiciones de Garantía 514



Condiciones de Venta 514



Simbología 515



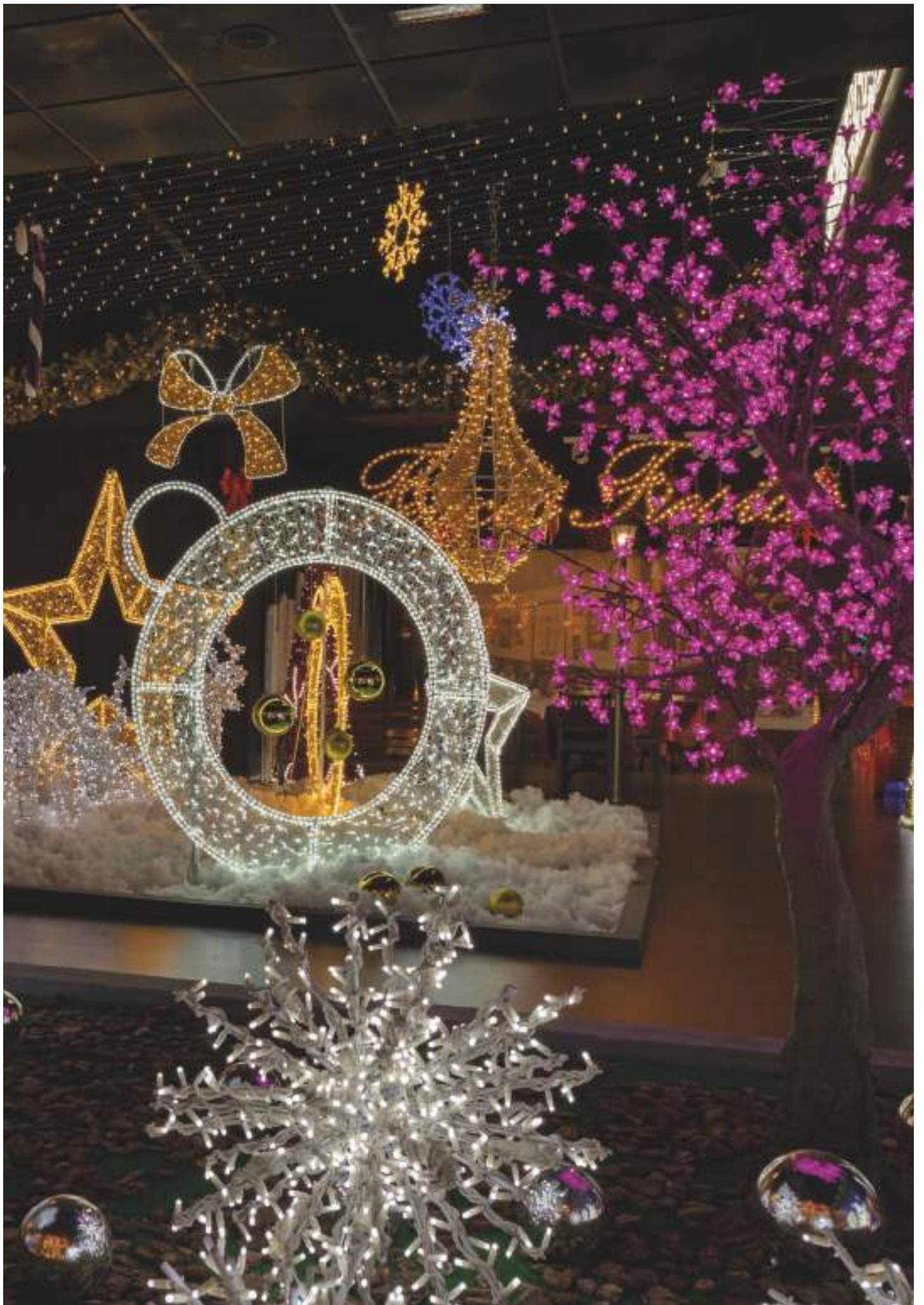





# PRILUX

## Ñ

Prilux es una empresa con más de 35 años de experiencia en el sector de la iluminación. Focalizada en I+D+i, ayudamos a las empresas, instituciones y propiedad final a iluminar sus espacios a través de productos y soluciones tecnológicas fiables, innovadoras, personalizadas, escalables y de alto valor añadido.

Nuestro objetivo es ofrecer al sector soluciones de iluminación inteligente en todas las áreas mediante el uso de sistemas de control y regulación. Por esta razón desarrollamos tecnología propia que permite una gestión óptima del consumo, mejorar el confort y generar un importante ahorro económico de forma sostenible.

Personalización, flexibilidad, eficiencia y sostenibilidad son los valores que nos mueven a diseñar y fabricar luminarias y tecnología para nuestros clientes.

Somos una ingeniería de valor en proyectos de alumbrado público, industrial, deportivo, arquitectural y festivo/navideño.

## E

Prilux is a company with over 35 years' experience in the lighting sector. Focusing on R&D&i, we help companies, institutions and final owners light their spaces using reliable, innovative, customised, scalable technological products and solutions with high added value.

Our aim is to provide the sector with smart lighting solutions in all areas, making use of control and regulating systems. We develop our own technology for this reason, to enable optimal management of consumption, improve comfort and generate significant economic savings sustainably.

Customisation, flexibility, efficiency, and sustainability are values that drive us in designing and manufacturing luminaires and technology for our customers.

We are a value engineering company in public, industrial, sporting, architectural and festive/ Christmas lighting projects.





## F

Prilux est une entreprise qui jouit de plus de 35 ans d'expérience dans le secteur de l'éclairage. Axée sur la R+D+i, nous aidons les entreprises, les institutions et les propriétaires finaux à éclairer leurs espaces grâce à des produits et des solutions technologiques fiables, innovatrices, personnalisées, évolutives et à forte valeur ajoutée.

Notre objectif : proposer au secteur des solutions d'éclairage intelligent dans tous les domaines à l'aide de systèmes de contrôle et de régulation. C'est pour cette raison que nous développons notre propre technologie de sorte à permettre une gestion optimale de la consommation, à améliorer le confort et à donner lieu à une importante économie d'énergie de manière durable.

Personnalisation, souplesse, efficacité et durabilité sont les valeurs qui nous encouragent à concevoir et à fabriquer des luminaires et une technologie adaptés à nos clients.

Nous sommes une entreprise d'ingénierie de grande valeur, qui travaille sur des projets d'éclairage public, industriel, sportif, architectural et festif/de Noël.

## P

A Prilux é uma empresa com mais de 35 anos de experiência no setor da iluminação. Focada em I+D+i, ajudamos as empresas, instituições e proprietários finais a iluminar os seus espaços através de produtos e soluções tecnológicas fiáveis, inovadoras, personalizadas, escaláveis e de elevado valor acrescentado.

O nosso objetivo é oferecer ao setor soluções de iluminação inteligente em todas as áreas, recorrendo à utilização de sistemas de controlo e regulação. Por este motivo desenvolvemos tecnologia própria que permite uma gestão otimizada do consumo, melhorar o conforto e gerar uma significativa poupança económica de forma sustentável.

Personalização, flexibilidade, eficiência e sustentabilidade são os valores que nos motivam a conceber e fabricar luminárias e tecnologia para os nossos clientes.

Somos uma empresa de engenharia de valor em projetos de iluminação pública, industrial, desportiva, arquitetural e festiva/natalícia.

# Infraestructuras

Infrastructures

Infraestructuras

Infraestructuras

## Toledo

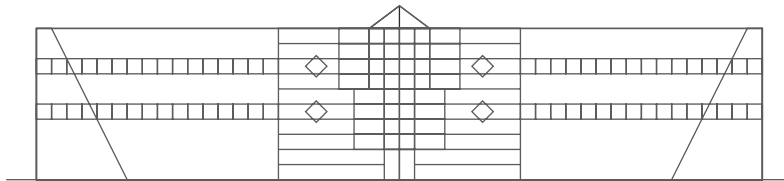

**16.500m<sup>2</sup>**

Almacén y centro productivo  
Warehouse & Production centre  
Stockage et centre de production  
Armazém e centro produtivo



**200m<sup>2</sup>**

Laboratorio  
Laboratories  
Laboratoires  
Laboratório



**300m<sup>2</sup>**

Salas limpias  
Clean rooms  
Salles blanches  
Salas limpas



**3.000m<sup>2</sup>**

Showrooms  
Showrooms  
Showrooms  
Showrooms

### Ñ

Con sede central en Toledo y delegación en Sant Llorenç d'Hortons (Barcelona), Prilux cuenta con modernas y amplias instalaciones que albergan espacios de oficina, conferencias, showrooms de exposición, laboratorio, almacenamiento, producción y salas limpias.

Además, nuestra delegación noreste actúa como plataforma logística para dar soporte al mercado internacional en Europa.

### E

With its headquarters in Toledo and branch in Sant Llorenç d'Hortons (Barcelona), Prilux has modern and extensive infrastructure housing storage, work and exhibition spaces such as: warehouses, production centres, laboratories, clean rooms, showrooms, training rooms and offices.

Also our northeast branch serves as a logistics platform for our expansion across Europe.

# Sant Llorenç d'Hortons (Barcelona)

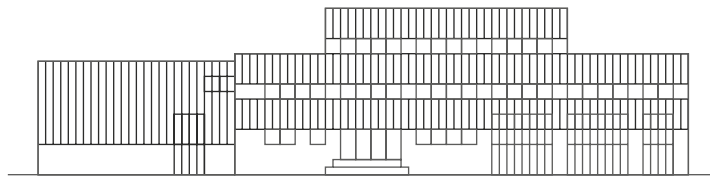

**13.000m<sup>2</sup>**

Almacén y centro productivo  
Warehouse & Production centre  
Stockage et centre de production  
Armazém e centro produtivo



**13**

Muelles de carga  
Loading bays  
Quais de chargement  
Cais de carga



**2.000m<sup>2</sup>**

Oficinas  
Offices  
Bureaux  
Escritórios



**2**

Showrooms  
Showrooms  
Showrooms  
Showrooms

## F

Le siège central de Prilux se trouve à Tolède et une antenne à Sant Llorenç d'Hortons (Barcelona), Prilux dispose d'infrastructures qui hébergent des espaces de stockage, de travail et d'exposition : entrepôts, centres de production, laboratoires, salles blanches, showrooms, salles de formation et bureaux.

De plus, notre délégation du Nord-est est une plate-forme logistique pour notre expansion en Europe.

## P

Com a sede central situada em Toledo e delegação em Sant Llorenç d'Hortons (Barcelona), Prilux dispõe de infraestruturas que compreendem espaços de armazenamento, trabalho e exposição como: armazéns, centros de produção, laboratórios, salas limpas, showrooms, salas de formação e escritórios.

Além disso, nossa delegação do noreste funciona como plataforma logística para a nossa expansão na Europa.

# Prilux around the world



Ñ

Tras 25 años centrados en el mercado español, exportamos principalmente a Europa, Europa del Este, Norte de África, Oriente Medio y América del Sur.

E

After 25 years focusing on the Spanish market, we export mainly to Europe, Eastern Europe, North Africa, the Middle East, South and America.

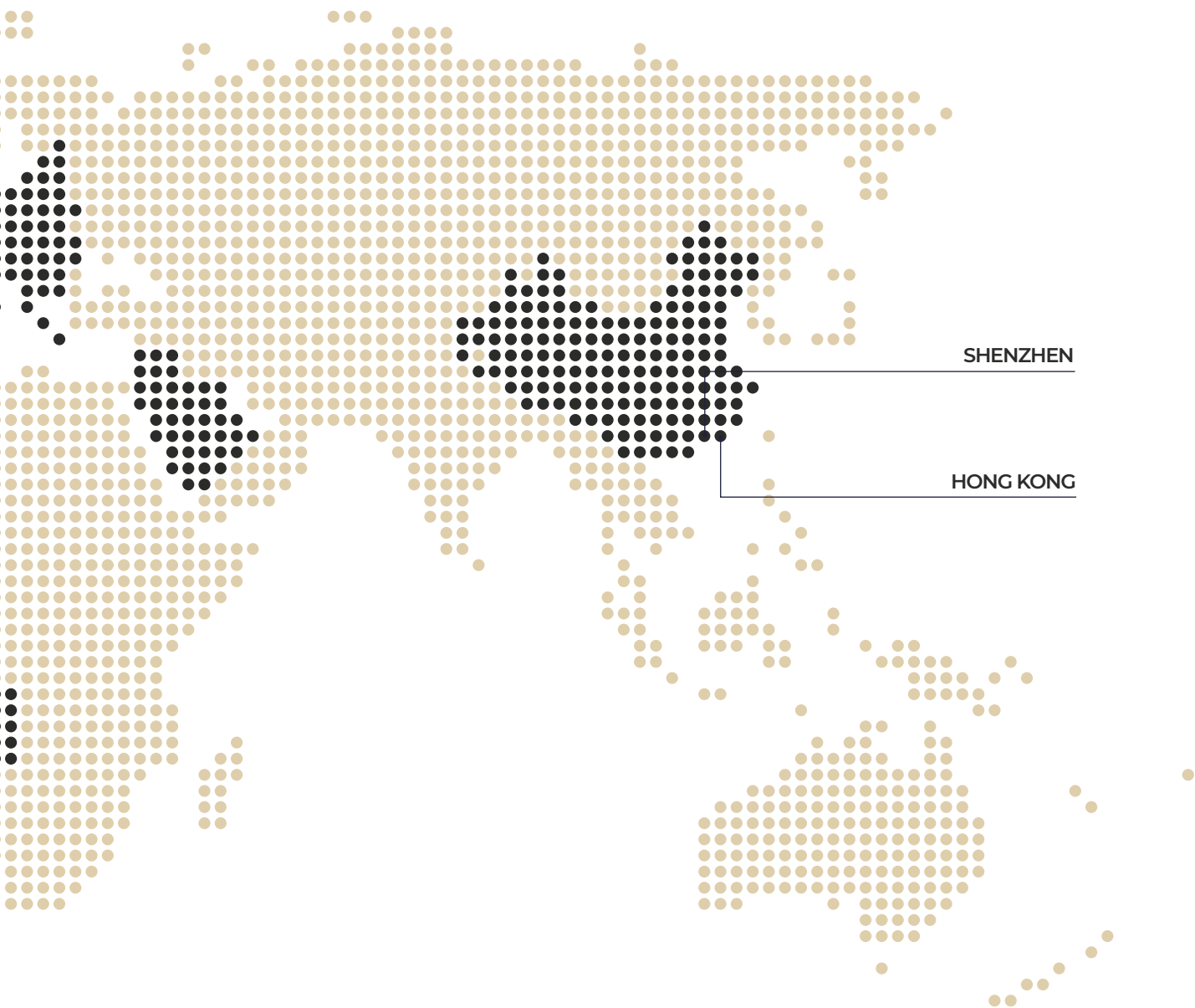

**F**

Après 25 ans centrés sur le marché espagnol, nous exportons principalement vers l'Europe, l'Europe de l'Est, l'Afrique du Nord, le Moyen Orient et l'Amérique du Sud

**P**

Após 25 anos concentrados no mercado espanhol, exportamos sobretudo para a Europa, Europa de Leste, Norte de África, Médio Oriente e América do Sul.

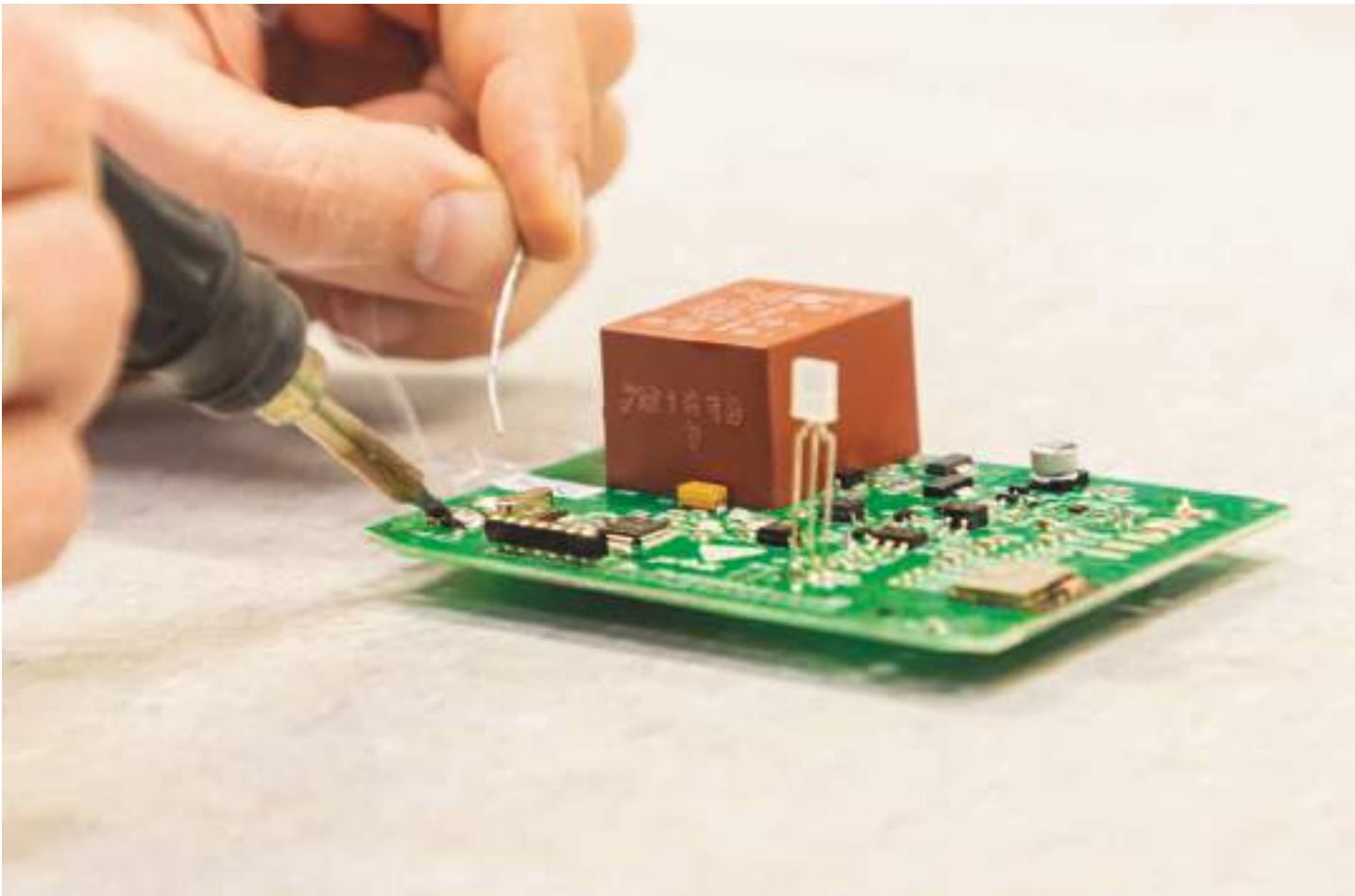

## I+D+i R&D&i

### Ñ

La innovación se ha convertido en una estrategia imprescindible para adaptarnos al mercado y su constante evolución. En Prilux apostamos por el futuro y nos apasiona diferenciar nuestros productos y soluciones explorando nuevos caminos a través de proyectos con varios horizontes temporales.

Trabajamos bajo softwares de última tecnología para mejorar la calidad de nuestros productos y adaptarnos a los cambios en el sector de forma ágil. Además, empleamos herramientas de simulación para predecir comportamientos y optimizar las soluciones.

### E

Innovation is strategic and essential for Prilux in its commitment to the future. At Prilux we are committed to the future and are passionate about differentiating our products and solutions by exploring new avenues in projects with varying timescales.

We work using state-of-the-art software to improve the quality of our products and adapt swiftly to changes in the sector. We also use simulation tools to predict behaviour and optimise solutions.



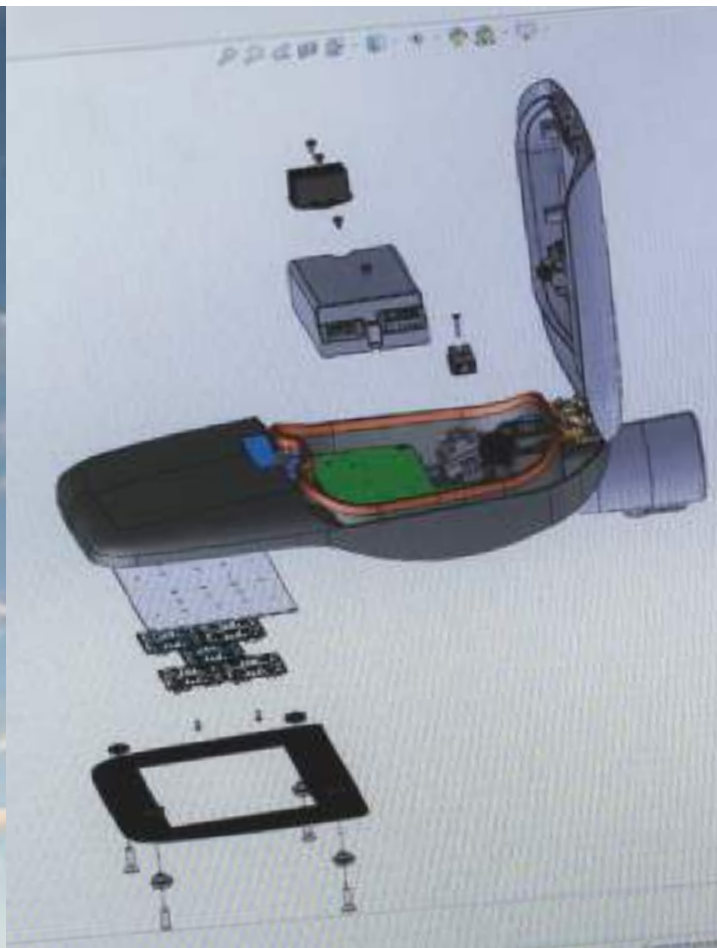

## F

Pour Prilux, l'innovation est stratégique et indispensable pour tenir notre pari sur l'avenir. Prilux mise sur l'avenir et n'a de cesse de différencier produits et solutions, et d'explorer de nouvelles voies à travers des projets s'étendant sur divers horizons de temps.

Nous travaillons avec des logiciels de pointe pour améliorer la qualité de nos produits et nous adapter avec souplesse aux changements que vit le secteur. Nous utilisons également des outils de simulation pour prédire les comportements et optimiser les solutions.

## P

A inovação para a Prilux é estratégica e indispensável ao apostar no futuro. Na Prilux apostamos no futuro e apaixonamos-nos diferenciar os nossos produtos e soluções explorando novos caminhos através de projetos com vários horizontes temporais.

Trabalhamos com softwares de última geração para melhorar a qualidade dos nossos produtos e nos adaptarmos às mudanças no setor de forma ágil. Além disso, utilizamos ferramentas de simulação para prever comportamentos e otimizar as soluções.

# Producción y Calidad

Production and quality

Fabrication et Qualité

Produção e Qualidade

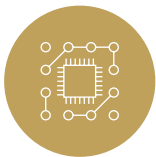

**Módulos LED propios**  
Own LED modules  
Modules LED propres  
Módulos LED próprios



**Control de calidad**  
Quality control  
Contrôle de qualité  
Controlo de qualidade



**Trazabilidad**  
Traceability  
Traçabilité  
Leitura



**Certificado ENEC (AENOR)**  
ENEC certification (AENOR)  
certificat ENEC (AENOR)  
certificado ENEC (AENOR)

## Ñ

Contamos con una “sala Blanca” equipada con una línea automática de montaje de componentes SMD (Serigrafía – Pick & Place – Horno) donde fabricamos todos nuestros módulos LED destinados a las soluciones lumínicas “made in Spain”.

Prilux dispone de un departamento de Calidad especializado tanto en la Calidad de Producto, como en el control de la Calidad Total empresarial que emplea la herramienta CERTOOL de AENOR para la gestión de la calidad y mejora continua de nuestros procesos. Este seguimiento permite ofrecer un servicio que cumpla con las especificaciones atribuidas en su totalidad.

Contamos con familias de productos con certificado ENEC, concedido por AENOR, que garantiza la calidad y seguridad de los productos, tanto en todo el proceso de fabricación, como cuando se introducen en el mercado.

## E

We have a “clean room” equipped with an automatic SMD component assembly line (Screen Printing – Pick & Place – Oven) where we manufacture all our LED modules for “made in Spain” lighting solutions.

Prilux has a Quality department specialising both in Product Quality and in corporate Total Quality control which uses AENOR’s CERTOOL tool for quality management and continuous improvement of our processes. This monitoring means it can offer a service that meets all attributed specifications in full.

We have product families with ENEC certification, granted by the Spanish standards organisation AENOR, guaranteeing product quality and safety, both throughout the manufacturing process and when they are placed on the market.



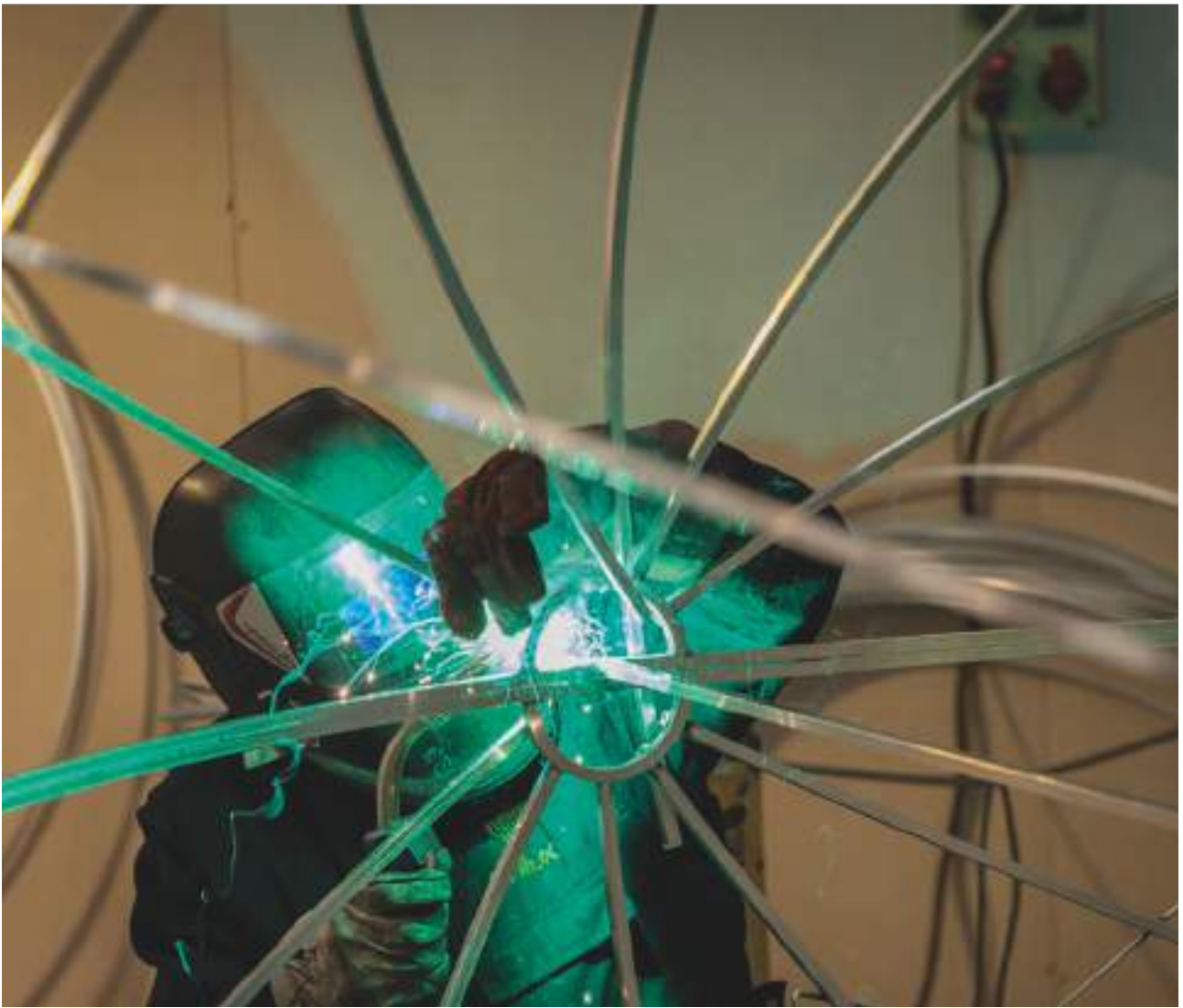

## F

Nous disposons d'une « salle blanche » équipée d'une ligne automatique de montage de composants SMD (sérigraphie - pick & place - four) où nous fabriquons tous nos modules LED destinés aux solutions d'éclairage « made in Spain ».

Prilux dispose d'un service qualité spécialisé aussi bien dans la qualité produit que dans le contrôle de la qualité intégrale de l'entreprise qui utilise l'outil AENOR CERTOOL pour la gestion de la qualité et l'amélioration continue de nos processus. Ce suivi permet de proposer un service répondant totalement aux spécifications attribuées.

Nous proposons des familles de produits certifiées ENEC, certification accordée par l'AENOR qui garantit la qualité et la sécurité des produits, aussi bien lors de l'ensemble du processus de fabrication que lors de leur mise sur le marché.

## P

Dispomos de uma “sala branca” equipada com uma linha automática de montagem de componentes SMD (Serigrafia – Pick & Place – Forno) onde fabricamos todos os nossos módulos LED destinados às soluções lumínicas “made in Spain”.

A Prilux possui um Departamento de Qualidade especializado tanto na Qualidade do Produto, como no controlo da Qualidade Total empresarial que utiliza a ferramenta AENOR CERTOOL para gestão da qualidade e melhoria contínua dos nossos processos. Este seguimento permite oferecer um serviço que cumpra as especificações atribuídas na sua totalidade.

Dispomos de famílias de produtos com certificado ENEC, concedido pela AENOR, que garante a qualidade e segurança dos produtos, tanto em todo o processo de fabrico como quando são introduzidos no mercado.

# Laboratorio

Laboratory

Laboratoire

Laboratório



Personalización  
Personalization  
Personnalisation  
Personalização



Goniofotómetro  
Goniophotometer  
Goniophotomètre  
Goniofotómetro



Ensayos IP / IK  
IP / IK Tests  
Essais IP / IK  
Ensaaios IP / IK



Esfera integradora  
Integrating sphere  
Sphère d'intégration  
Esfera integradora

## Ñ

Prilux dispone de laboratorio propio equipado con capacidad material y competencia técnica para realizar los ensayos de precertificación de luminarias según UNE-EN 60598 y fuentes de luz.

realizamos la caracterización de seguridad: durabilidad, calentamiento, IP, IK, dieléctricos...; eléctrica; fotométrica bajo EN 13032; espectral según CIE S-025 y TM30-15, con evaluación del cumplimiento de las directivas de protección del cielo; flicker según nueva regulación de ecodiseño; parámetros de Human Centric Lighting (HCL) y medidas para horticultura.

Para cubrir las demandas más exigentes llevamos a nuestras luminarias a situaciones extremas en términos de regulación, rangos de funcionamiento, altas temperaturas, congelación, conmutaciones y forzado de protecciones que se dan en situaciones reales.

Acompañamos al cliente en su necesidad de justificar el cumplimiento de los requisitos demandados por áreas de negocio o mercados como los árabes, industria alimentaria, HCL en el ámbito de educación, sanidad, geriatría, etc.

Llevamos a cabo las tareas de certificación con laboratorios y entidades acreditadas externas para conseguir los certificados de producto ENEC, CB, N, IAC, y asegurar el cumplimiento de los requisitos del CEI-IDAE vigentes.

## E

Prilux has its own laboratory equipped with the physical capability and technical competence to carry out pre-certification tests on luminaires under the UNE-EN 60598 standard and on light sources.

We perform characterisation of safety: endurance, thermal, ip, ik, dielectric...; electrical; photometric under EN 13032; spectral according to CIE S-025 and TM30-15, also evaluating compliance with directives on protection of the night sky; flicker according to new eco-design regulations; and human centric lighting (HCL) parameters and make measurements for horticulture.

To meet the most demanding requirements, we subject our luminaires to extreme conditions in terms of regulation, operating ranges, high temperatures, freezing, switching, and forcing of protections that occur in real situations. We work with our customers where they need to support compliance with requirements demanded by business sectors or markets, such as Arabian markets, the food industry, HCL in education, health care and geriatric fields, etc.

We conduct certification tasks with external laboratories and accredited entities to obtain ENEC, CB, N and Canary Islands Astrophysical Institute (IAC) product certificates and to ensure compliance with current Spanish Lighting Committee/Institute for Diversification and Saving of Energy (CEI-IDAE) requirements.



## F

Prilux dispose de son propre laboratoire doté de la capacité matérielle et de la compétence technique nécessaires pour procéder aux tests de pré-certification de luminaires selon la norme UNE-EN 60598 et sources lumineuses.

Nous réalisons la caractérisation de sécurité: endurance, chauffage, ip, ik, diélectriques... ; électrique ; photométrie selon la norme EN 13032 ; spectrale selon la norme CIE S-025 et TM30-15, avec évaluation de la conformité aux directives de protection du ciel ; flicker selon la nouvelle réglementation sur l'écoconception ; paramètres de human centric lighting (HCL) et prise de mesures pour l'horticulture.

Pour répondre aux demandes les plus exigeantes, nous soumettons nos luminaires à des situations extrêmes en termes de réglementation, fourchettes de fonctionnement, hautes températures, congélation, commutations et forçage de protections, comme dans les situations réelles. Nous accompagnons le client dans ses besoins de justification du respect des exigences posées par les différents domaines d'activité ou marchés, comme le marché arabe, l'industrie alimentaire, le HCL dans le domaine de l'éducation, la santé, la gériatrie, etc.

Nous nous livrons à des travaux de certification avec des laboratoires et établissements agréés externes pour obtenir les certificats de produits ENEC, CB, N, IAC et garantir le respect des exigences CEI-IDAE en vigueur.

## P

A Prilux dispõe de laboratório próprio equipado com capacidade material e competência técnica para realizar os ensaios de pré-certificação de luminárias segundo a UNE-EN 60598 e fontes de luz.

Realizamos a caracterização de segurança: resistência, aquecimento, ip, ik, dielétricos...; elétrica; fotométrica segundo a EN 13032; espectral segundo a CIE S-025 e TM30-15, com avaliação do cumprimento das diretivas de proteção do céu; flicker segundo a nova regulamentação de ecodesign; parâmetros de human centric lighting (HCL) e medidas para horticultura.

Para satisfazer as necessidades mais exigentes levamos as nossas luminárias a situações extremas em termos de regulação, faixas de funcionamento, altas temperaturas, congelamento, comutações e forçamento de proteções que ocorrem em situações reais.

Acompanhamos o cliente na sua necessidade de comprovar o cumprimento dos requisitos exigidos por áreas de negócio ou mercados como os árabes, indústria alimentar, HCL no âmbito do ensino, saúde, geriatria, etc.

Realizamos as tarefas de certificação com laboratórios e entidades acreditadas externas para obter os certificados de produto ENEC, CB, N, IAC, e garantir o cumprimento dos requisitos do CEI-IDAE em vigor.

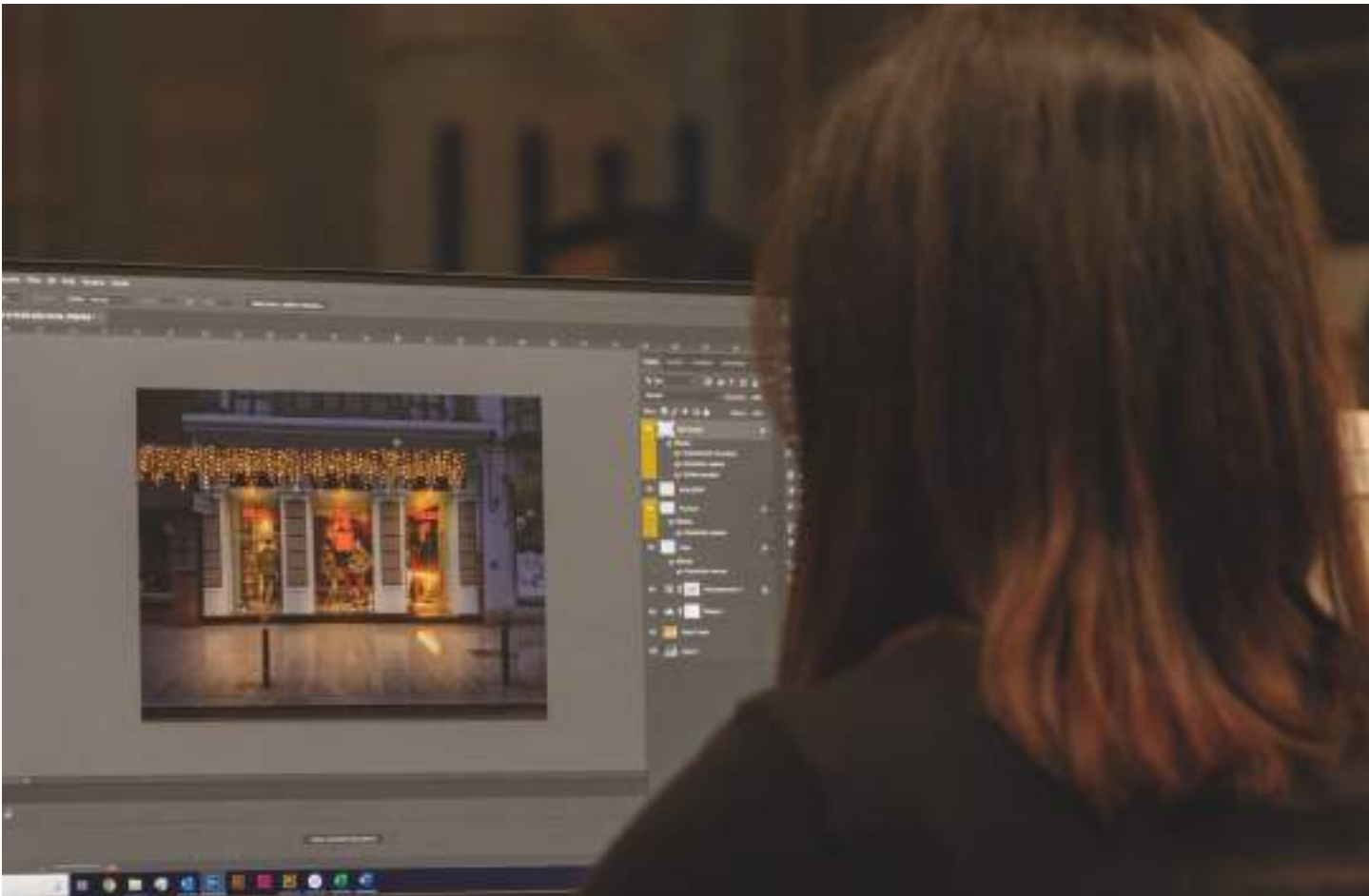

# Proyectos

## Projets / Projets / Projetos

### Ñ

Para las obras con mayores exigencias técnicas ponemos a disposición de nuestros clientes el departamento de proyectos, en el cual se estudian y diseñan soluciones lumínicas a través de software específico para ello.

Actualmente disponemos de soluciones tecnológicas de iluminación con sistemas de control integrados según demanda para la industria, oficinas, alumbrado público y vial, tiendas de retail, supermercados y centros comerciales, aplicaciones deportivas, parkings, hoteles, hospitales, colegios y universidades... Aportamos soluciones de iluminación creativas, personalizadas y adaptadas a las necesidades de nuestros clientes y ajustadas a la norma con un enfoque particular hacia el bienestar humano y la eficiencia energética.

### E

For projects of major technical demand we provide our clients with access to the projects' department, which studies and designs lighting solutions by means of software specifically tailored for this purpose.

At present we provide on-demand lighting technological solutions with integrated control systems for industrial facilities, offices, public and street lighting, retail stores, supermarkets and shopping centres, sport facilities, car parks, hotels, hospitals, schools and universities... We offer creative, customised lighting solutions adapted to the needs of our clients and in compliance with regulations, with a particular focus on human welfare and energy efficiency.





## F

Pour les travaux présentant des exigences techniques plus importantes, nous mettons à disposition de nos clients le département de projets, où les solutions d'éclairage sont étudiées et conçues grâce à un logiciel spécifique.

Nous disposons actuellement de solutions technologiques d'éclairage avec des systèmes de contrôle intégrés en fonction de la demande pour l'industrie, bureaux, l'éclairage public et routier, boutiques de vente au détail, supermarchés, centres commerciaux, applications sportives, parkings, hôtels, hôpitaux, écoles et universités... Nous fournissons des solutions d'éclairage créatives, personnalisées et adaptées aux besoins de nos clients, mais aussi conformes à la réglementation, avec une approche particulière focalisée sur le bien-être humain et l'efficacité énergétique.

## P

Para as obras com maiores exigências técnicas colocámos á disposição dos nossos clientes o nosso departamento de projectos, no qual se estudam e desenham soluções luminicas através de software específico para o efeito.

Actualmente dispomos de soluções tecnológicas de iluminação com sistemas de controlo integrados a pedido para a indústria, escritórios, iluminação pública e viária, lojas de retalho, supermercados e centros comerciais, aplicações desportivas, parques de estacionamento, hoteis, hospitais, escolas e universidades... Temos soluções de iluminação criativas, personalizadas e adaptadas às necessidades dos nossos clientes e ajustadas á norma com um foco particular no bem estar do ser humano e na eficiência energética.

# Hacemos realidad tus ideas

We make your ideas come true

Nous réalisons vos idées

Nós tornamos suas ideias realidade



## Ideación de la campaña

Campaign brainstorming  
Remue-méninges de la  
campagne  
Brainstorming da  
campanha



## Fase comercial

Commercial step  
Etape commerciale  
Etapa comercial

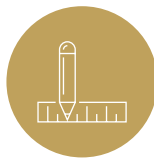

## Proyectos

Projects  
Projets  
Projetos



## Fabricación

Manufacturing  
Fabrication  
Fabricação

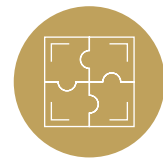

## Montaje

Mounting  
Montage  
Montagem

## Ñ

En **Prilux** diseñamos y producimos el 100% de los motivos en nuestras instalaciones de Toledo garantizando, su alta calidad y el cumplimiento de los plazos de entrega. Esto nos permite ofrecer la posibilidad, bajo pedido, de personalización de motivos adaptados totalmente a las necesidades y exigencias del cliente.

Nuestro departamento de Proyectos realiza simulaciones de decoraciones a partir de fotografías en las que se personalizan las decoraciones según las tendencias o directrices que nos marque el cliente. Proporcionamos asesoramiento, apoyo y orientación técnica adecuada para la obtención del mejor proyecto decorativo.

## E

In **Prilux** we design and manufacture 100% of the lighting motifs in our facilities in Toledo, ensuring not only high quality but also meeting the most challenging deadlines. We offer the possibility, on demand, of customizing and adapt the motif to any kind of demands and needs from the customer.

For this purpose, our Project Department carries out simulations of decorations from photographs in which, according to the last trends and client's guidelines, we customize all the motif. Moreover, we provide to our customers a good piece of advice, support and guidance to get the best decorative project.



## F

Chez **Prilux** nous concevons et produisons 100% des motifs dans nos installations de Tolède, en garantissant leur haute qualité et le respect des délais de livraison. Cela nous permet d'offrir la possibilité, sur demande, de personnaliser des motifs entièrement adaptés aux besoins et aux exigences du client.

Notre département Projets réalise des simulations de décorations à partir de photographies dans lesquelles les décorations sont personnalisées selon les tendances ou les directives fixées par le client. Nous fournissons des conseils, un soutien et des conseils techniques adéquats pour obtenir le meilleur projet décoratif.

## P

Na **Prilux** desenhamos e produzimos 100% dos motivos nas nossas instalações em Toledo, garantindo a sua elevada qualidade e cumprimento dos prazos de entrega. Isto permite-nos oferecer a possibilidade, a pedido, de personalizar motivos totalmente adaptados às necessidades e exigências do cliente.

O nosso departamento de Projetos realiza simulações de decorações a partir de fotografias em que as decorações são personalizadas de acordo com as tendências ou orientações definidas pelo cliente. Prestamos assessoria, apoio e orientação técnica adequada para obter o melhor projeto decorativo.







# Motivos

Motifs  
Motifs  
Motivos



# Colección Shinning

Star

Snow Star

Venus Star

Ball

Screen Star

Bouquet Star

Hanging Ball

Star 3D

# Star









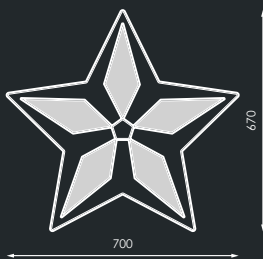

## Colección Shinning

**N**  
NEW



**Motivo**  
 Motifs  
 Motifs  
 Motivos



|   |   |  |  |  |  |  |
|---|---|--|--|--|--|--|
|  |  |   |   |  |  |  |
| 631938  | flexi LED   | flexi LED  | PMMA   |  |  |  |
| <b>W</b>  |   |  |  |  |  |  |
| 9W  | 230V  | CII  | IP65<br>IP44 Plug  | 3,5kg  | 75x72x5cm  | INC.   |

# Snow Star









## Colección Shinning

**N**  
NEW



**Motivo**  
 Motifs  
 Motifs  
 Motivos



|   |   |   |   |   |   |   |
|---|---|---|---|---|---|---|
|  |  |  |   |   |   |   |
| 631952  | flexi LED   | PMMA  |   |   |   |   |
| <b>W</b>  |    |  |  |  |  |  |
| 9W  | 230V  | CII   | IP65<br>IP44 Plug   | 3,8kg   | 65x57x5cm   | INC.  |

# Venus Star

## Colección Shinning

Motivo  
Motifs  
Motifs  
Motivos



**N**  
NEW



|        |          |          |      |           |       |            |      |
|--------|----------|----------|------|-----------|-------|------------|------|
|        |          |          |      |           |       |            |      |
| 631976 | flexiLED | flexiLED | PMMA |           |       |            |      |
|        |          |          |      |           |       |            |      |
| 14,5W  | 230V     | CII      | IP65 | IP44 Plug | 6,6kg | 97x97x12cm | INC. |



# Ball

## Colección Shinning

Motivo  
Motifs  
Motifs  
Motivos



**N**  
NEW



|        |          |      |      |           |     |            |      |
|--------|----------|------|------|-----------|-----|------------|------|
|        |          |      |      |           |     |            |      |
| 631990 | flexiLED | PMMA |      |           |     |            |      |
|        |          |      |      |           |     |            |      |
| 9W     | 230V     | CII  | IP65 | IP44 Plug | 6kg | 82x67x12cm | INC. |





# Screen Star

## Colección Shinning



**N**  
NEW

**Motivo**  
 Motifs  
 Motifs  
 Motivos

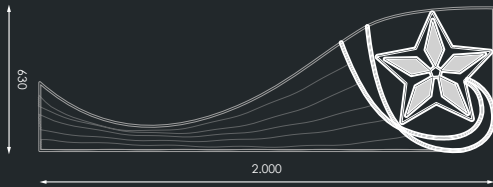

|        |          |          |                   |             |
|--------|----------|----------|-------------------|-------------|
|        | 1        | 2        |                   |             |
| 631945 | flexiLED | flexiLED | STRING PLUS       | LED         |
| W      |          |          |                   |             |
| 25W    | 230V     | CII      | IP65<br>IP44 Plug | 15kg        |
|        |          |          |                   | 207x70x23cm |
|        |          |          |                   | INC.        |

# Bouquet Star

## Colección Shinning



**N**  
NEW

**Motivo**  
 Motifs  
 Motifs  
 Motivos

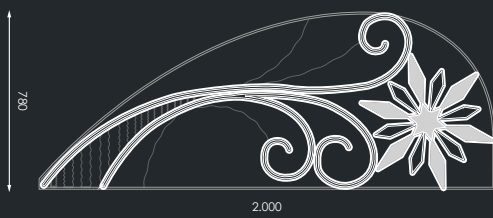

|        |          |          |                   |             |
|--------|----------|----------|-------------------|-------------|
|        | 1        | 2        |                   |             |
| 631969 | flexiLED | flexiLED | STRING PLUS       | LED         |
| W      |          |          |                   |             |
| 35,2W  | 230V     | CII      | IP65<br>IP44 Plug | 16,8kg      |
|        |          |          |                   | 207x85x23cm |
|        |          |          |                   | INC.        |

[GRÁFICOS: Unidades en mm/ GRAPHICS: Units in mm/ GRAPHIQUES: Unités en mm/ GRÁFICOS: Unidades em mm]

# Loop

## Colección Shinning

Motivo  
Motifs  
Motifs  
Motivos



**N**  
NEW



|        |          |                 |                   |        |             |      |
|--------|----------|-----------------|-------------------|--------|-------------|------|
|        |          |                 |                   |        |             |      |
| 631983 | flexiLED | STRING PLUS LED | PMMA              |        |             |      |
| W      |          |                 |                   |        |             |      |
| 38W    | 230V     | CII             | IP65<br>IP44 Plug | 16,4kg | 208x95x23cm | INC. |

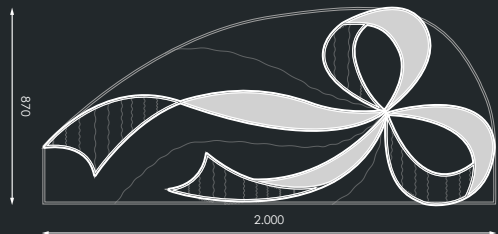

# Hanging Ball

## Colección Shinning

Motivo  
Motifs  
Motifs  
Motivos



**N**  
NEW



|        |          |          |                   |        |              |      |
|--------|----------|----------|-------------------|--------|--------------|------|
|        |          |          |                   |        |              |      |
| 632003 | flexiLED | flexiLED | PMMA              |        |              |      |
| W      |          |          |                   |        |              |      |
| 31,8W  | 230V     | CII      | IP65<br>IP44 Plug | 17,2kg | 178x100x23cm | INC. |

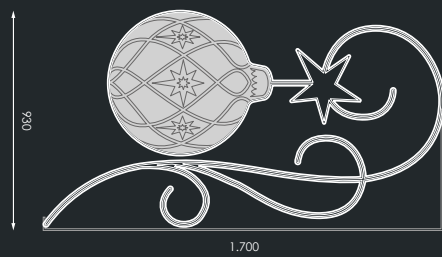

# Star 3D

## Colección Shinning

**N**  
NEW

**3D** Motivo  
Motifs  
Motifs  
Motivos

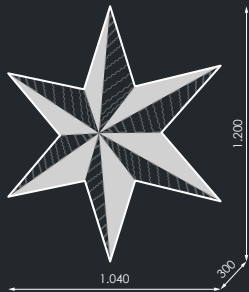

|        |                               |         |                   |        |              |      |
|--------|-------------------------------|---------|-------------------|--------|--------------|------|
|        |                               |         |                   |        |              |      |
| 632010 | STRING <b>PLUS</b> <b>LED</b> | PVC NET | PMMA              |        |              |      |
|        |                               |         |                   |        |              |      |
| 24W    | 230V                          | CII     | IP65<br>IP44 Plug | 11,5kg | 127x111x36cm | INC. |



# Colección Chasing

Falling Star

Explosion Star

Portal Star 2D



# Falling Star

## Colección Chasing

**N**  
NEW



Motivo  
Motifs  
Motifs  
Motivos

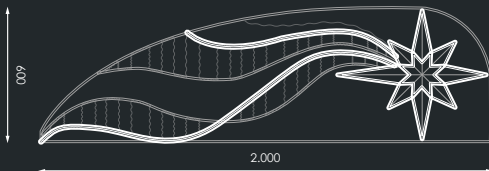
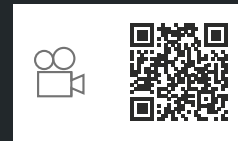

|        |          |                  |                   |      |             |      |
|--------|----------|------------------|-------------------|------|-------------|------|
|        | 1        | 2                |                   |      |             |      |
| 632027 | flexiLED | flexiCHASING LED | STRING PLUS LED   |      |             |      |
| W      |          |                  |                   |      |             |      |
| 37W    | 230V     | CII              | IP65<br>IP44 Plug | 16kg | 208x68x23cm | INC. |

# Explosion Star

## Colección Chasing

**N**  
NEW



Motivo  
Motifs  
Motifs  
Motivos

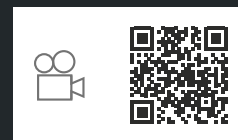

|        |          |                  |                   |        |             |      |
|--------|----------|------------------|-------------------|--------|-------------|------|
|        | 1        | 2                |                   |        |             |      |
| 632041 | flexiLED | flexiCHASING LED | STRING PLUS LED   |        |             |      |
| W      |          |                  |                   |        |             |      |
| 48,5W  | 230V     | CII              | IP65<br>IP44 Plug | 14,6kg | 208x60x23cm | INC. |



# Portal Star 2D

## Colección Chasing

**N**  
NEW

Motivo  
Motifs  
Motifs  
Motivos



|        |          |                   |                   |         |              |      |      |
|--------|----------|-------------------|-------------------|---------|--------------|------|------|
|        | 1        | 2                 | 1                 | 2       |              |      |      |
| 632058 | flexiLED | flexi CHASING LED | STRING PLUS LED   | PVC.NET |              |      |      |
| W      |          |                   |                   |         |              |      |      |
| 134W   | 24V      | CIII              | IP65<br>IP44 Plug | 45kg    | 188x120x58cm | INC. | 20mm |

Información/Information/Information/Informações

Ñ/ Estructura dorada.

E/ Gold-plated structure.

F/ Structure plaquée or.

P/ Estrutura banhada a ouro.

[GRÁFICOS: Unidades en mm/ GRAPPHICS: Units in mm/ GRAPPHIQUES: Unités en mm/ GRÁFICOS: Unidades em mm]

# Colección Straight

---

Holly

Pine Forest

Tree

Reindeer Face

Reindeer Body

3D Tree

3D Cone

3D Pine Forest





MADE IN SPAIN  
Desing by PRILUX

# Holly

## Colección Straight



Motivo  
Motifs  
Motifs  
Motivos



A



B



C



D

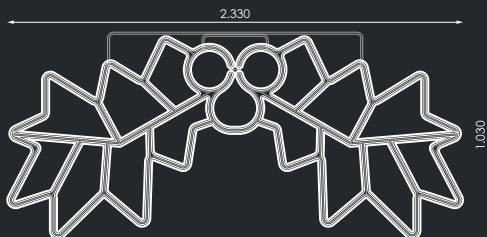

|        |   |
|--------|---|
|        |   |
| 477192 | A |
|        |   |
| 477260 | B |
|        |   |

|     |      |     |                   |     |             |      |      |
|-----|------|-----|-------------------|-----|-------------|------|------|
| W   |      |     |                   |     |             |      |      |
| 86W | 230V | CII | IP65<br>IP44 Plug | 4kg | 240x110x6cm | INC. | 10mm |

|        |   |          |          |
|--------|---|----------|----------|
|        |   | <b>1</b> | <b>2</b> |
| 477338 | C |          | STRING   |
|        |   |          | PVC NET  |
| 477406 | D |          | STRING   |
|        |   |          | PVC NET  |

|      |      |     |                   |      |             |      |      |
|------|------|-----|-------------------|------|-------------|------|------|
| W    |      |     |                   |      |             |      |      |
| 108W | 230V | CII | IP65<br>IP44 Plug | 12kg | 240x110x6cm | INC. | 10mm |

[GRÁFICOS: Unidades en mm/ GRAPHICS: Units in mm/ GRAPHIQUES: Unités en mm/ GRÁFICOS: Unidades em mm]

# Pine Forest

## Colección Straight



MADE IN SPAIN  
Desing by PRILUX

Motivo  
Motifs  
Motifs  
Motivos



A



B



C



D



|        |   |                 |  |
|--------|---|-----------------|--|
|        |   |                 |  |
| 477178 | A | <b>flexiLED</b> |  |
| 477246 | B | <b>flexiLED</b> |  |

|     |      |     |                   |       |            |      |      |
|-----|------|-----|-------------------|-------|------------|------|------|
| W   |      |     |                   |       |            |      |      |
| 52W | 230V | CII | IP65<br>IP44 Plug | 3,5kg | 215x80x6cm | INC. | 10mm |

|        |   |                 |                        |         |  |  |
|--------|---|-----------------|------------------------|---------|--|--|
|        |   |                 |                        |         |  |  |
| 477314 | C | <b>flexiLED</b> | STRING <b>PLUS LED</b> | PVC NET |  |  |
| 477383 | D | <b>flexiLED</b> | STRING <b>PLUS LED</b> | PVC NET |  |  |

|     |      |     |                   |     |            |      |      |
|-----|------|-----|-------------------|-----|------------|------|------|
| W   |      |     |                   |     |            |      |      |
| 63W | 230V | CII | IP65<br>IP44 Plug | 8kg | 215x80x6cm | INC. | 10mm |





MADE IN SPAIN  
Desing by PRILUX

# Pine Forest Colección Straight

**Motivo**  
 Motifs  
 Motifs  
 Motivos



A



B

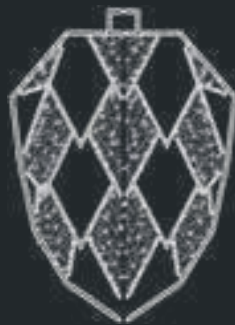

C



D

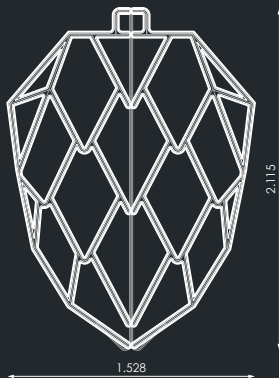

|        |   |
|--------|---|
|        |   |
| 477154 | A |
| 477222 | B |

|     |      |     |                   |     |             |      |      |
|-----|------|-----|-------------------|-----|-------------|------|------|
|     |      |     |                   |     |             |      |      |
| 86W | 230V | CII | IP65<br>IP44 Plug | 6kg | 215x160x6cm | INC. | 10mm |

|        |   |        |         |
|--------|---|--------|---------|
|        |   |        |         |
| 477291 | C | STRING | PVC NET |
| 477369 | D | STRING | PVC NET |

|      |      |     |                   |      |             |      |      |
|------|------|-----|-------------------|------|-------------|------|------|
|      |      |     |                   |      |             |      |      |
| 108W | 230V | CII | IP65<br>IP44 Plug | 12kg | 215x160x6cm | INC. | 10mm |

[GRÁFICOS: Unidades en mm/ GRAPHICS: Units in mm/ GRAPHIQUES: Unités en mm/ GRÁFICOS: Unidades em mm]

# Tree

## Colección Straight



MADE IN SPAIN  
Desing by PRILUX

Motivo  
Motifs  
Motifs  
Motivos



A



B



C



D



|        |                   |
|--------|-------------------|
|        |                   |
| 477185 | A <b>flexiLED</b> |
| 477253 | B <b>flexiLED</b> |

|     |      |     |                   |       |            |      |      |
|-----|------|-----|-------------------|-------|------------|------|------|
| W   |      |     |                   |       |            |      |      |
| 38W | 230V | CII | IP65<br>IP44 Plug | 3,5kg | 220x70x6cm | INC. | 10mm |

|        |   |                 |                        |         |
|--------|---|-----------------|------------------------|---------|
|        |   |                 |                        |         |
| 477321 | C | <b>flexiLED</b> | STRING <b>PLUS LED</b> | PVC NET |
| 477390 | D | <b>flexiLED</b> | STRING <b>PLUS LED</b> | PVC NET |

|     |      |     |                   |     |            |      |      |
|-----|------|-----|-------------------|-----|------------|------|------|
| W   |      |     |                   |     |            |      |      |
| 48W | 230V | CII | IP65<br>IP44 Plug | 5kg | 220x70x6cm | INC. | 10mm |







[GRÁFICOS: Unidades em mm/GRÁFICOS: Units in mm/GRÁFICOS: Unidades em mm/GRÁFICOS: Unidades em mm]

CC Boulevard Vitoria  
Vitoria

# Tree

## Colección Straight

Motivo  
Motifs  
Motifs  
Motivos



A



B



C



D



|        |   |                 |  |
|--------|---|-----------------|--|
|        |   |                 |  |
| 477161 | A | <b>flexiLED</b> |  |
| 477239 | B | <b>flexiLED</b> |  |

|     |      |     |                   |     |             |      |      |
|-----|------|-----|-------------------|-----|-------------|------|------|
|     |      |     |                   |     |             |      |      |
| 75W | 230V | CII | IP65<br>IP44 Plug | 5kg | 220x140x6cm | INC. | 10mm |

|        |   |                 |                        |
|--------|---|-----------------|------------------------|
|        |   |                 |                        |
| 477307 | C | <b>flexiLED</b> | STRING <b>PLUS LED</b> |
| 477376 | D | <b>flexiLED</b> | STRING <b>PLUS LED</b> |
|        |   |                 | PVC NET                |

|     |      |     |                   |      |             |      |      |
|-----|------|-----|-------------------|------|-------------|------|------|
|     |      |     |                   |      |             |      |      |
| 95W | 230V | CII | IP65<br>IP44 Plug | 10kg | 220x140x6cm | INC. | 10mm |







MADE IN SPAIN  
Desing by PRILUX

# Reindeer Body

## Colección Straight

Motivo  
Motifs  
Motifs  
Motivos



A



B



C



D

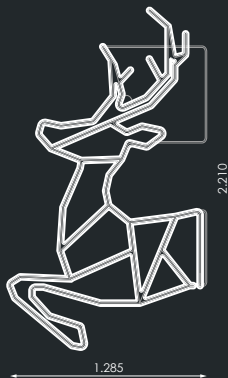

|        |   |
|--------|---|
|        |   |
| 477888 | A |
| 477895 | B |

|     |      |     |                   |       |             |      |      |
|-----|------|-----|-------------------|-------|-------------|------|------|
|     |      |     |                   |       |             |      |      |
| 74W | 230V | CII | IP65<br>IP44 Plug | 7,5kg | 225x135x6cm | INC. | 10mm |

|        |   |        |         |
|--------|---|--------|---------|
|        |   |        |         |
| 477901 | C | STRING | PVC NET |
| 477918 | D | STRING | PVC NET |

|     |      |     |                   |      |             |      |      |
|-----|------|-----|-------------------|------|-------------|------|------|
|     |      |     |                   |      |             |      |      |
| 84W | 230V | CII | IP65<br>IP44 Plug | 10kg | 225x135x6cm | INC. | 10mm |

[GRÁFICOS: Unidades en mm/ GRAPHICS: Units in mm/ GRAPHIQUES: Unités en mm/ GRÁFICOS: Unidades em mm]



CC Boulevard Vitoria  
Vitoria



MADE IN SPAIN  
Desing by PRILUX

# Reindeer Body

## Colección Straight



Motivo  
Motifs  
Motifs  
Motivos



A



B



C



D



|        |   |
|--------|---|
|        |   |
| 477208 | A |
|        |   |
| 477277 | B |
|        |   |

|     |      |     |                   |       |             |      |      |
|-----|------|-----|-------------------|-------|-------------|------|------|
| W   |      |     |                   |       |             |      |      |
| 99W | 230V | CII | IP65<br>IP44 Plug | 7,5kg | 265x215x6cm | INC. | 10mm |

|        |   |  |         |
|--------|---|--|---------|
|        |   |  |         |
| 477345 | C |  | STRING  |
|        |   |  | PVC NET |
| 477413 | D |  | STRING  |
|        |   |  | PVC NET |

|      |      |     |                   |      |             |      |      |
|------|------|-----|-------------------|------|-------------|------|------|
| W    |      |     |                   |      |             |      |      |
| 113W | 230V | CII | IP65<br>IP44 Plug | 11kg | 265x215x6cm | INC. | 10mm |

[GRÁFICOS: Unidades en mm/ GRAPHICS: Units in mm/ GRAPHIQUES: Unités en mm/ GRÁFICOS: Unidades em mm]



# Reindeer Face

## Colección Straight



MADE IN SPAIN  
Desing by PRILUX

Motivo  
Motifs  
Motifs  
Motivos



|        |   |          |  |
|--------|---|----------|--|
|        |   |          |  |
| 477147 | A | flexiLED |  |
| 477215 | B | flexiLED |  |

|      |      |     |      |      |      |      |                                      |      |      |
|------|------|-----|------|------|------|------|--------------------------------------|------|------|
|      |      |     |      |      |      |      |                                      |      |      |
| 282W | 230V | CII | IP65 | IP44 | Plug | 32kg | 2- 205x165x7,5cm<br>2- 305x133x7,5cm | INC. | 25mm |

|        |   |          |                 |         |  |
|--------|---|----------|-----------------|---------|--|
|        |   |          |                 |         |  |
| 477284 | C | flexiLED | STRING PLUS LED | PVC NET |  |
| 477352 | D | flexiLED | STRING PLUS LED | PVC NET |  |

|      |      |     |      |      |      |      |                                      |      |      |
|------|------|-----|------|------|------|------|--------------------------------------|------|------|
|      |      |     |      |      |      |      |                                      |      |      |
| 338W | 230V | CII | IP65 | IP44 | Plug | 48kg | 2- 205x165x7,5cm<br>2- 305x133x7,5cm | INC. | 25mm |







A



B



C



D

# 3D Tree

## Colección Straight



MADE IN SPAIN  
Desing by PRILUX

Motivo  
Motifs  
Motifs  
Motivos

3D

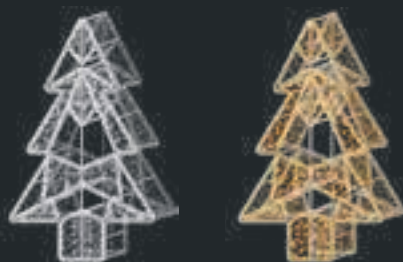

A

B



|        |     | 1        | 2                       |
|--------|-----|----------|-------------------------|
| 509633 | A   | flexiLED | STRING PLUS LED PVC NET |
| 509664 | B   | flexiLED | STRING PLUS LED PVC NET |
| W      | ⚡   | ⚠        | ⦿                       |
| 115W   | 24V | CIII     | IP65<br>IP44 Plug       |
|        |     | 23kg     | 218x132x27cm            |
|        |     |          | INC. 10mm               |



# 3D Cone

## Colección Straight



MADE IN SPAIN  
Desing by PRILUX

Motivo  
Motifs  
Motifs  
Motivos

3D

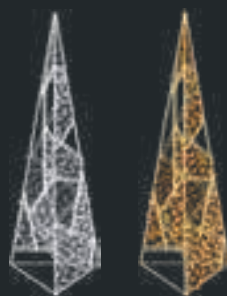

A

B



|        |     | 1        | 2                       |
|--------|-----|----------|-------------------------|
| 509619 | A   | flexiLED | STRING PLUS LED PVC NET |
| 509640 | B   | flexiLED | STRING PLUS LED PVC NET |
| W      | ⚡   | ⚠        | ⦿                       |
| 60W    | 24V | CIII     | IP65<br>IP44 Plug       |
|        |     | 14,5kg   | 255x70x70cm             |
|        |     |          | INC. 10mm               |

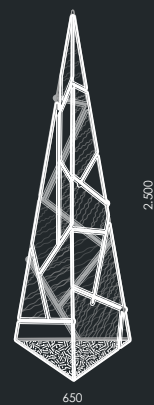



MADE IN SPAIN  
Desing by PRILUX

# 3D Pine Forest

## Colección Straight

3D Motivo  
Motifs  
Motifs  
Motivos

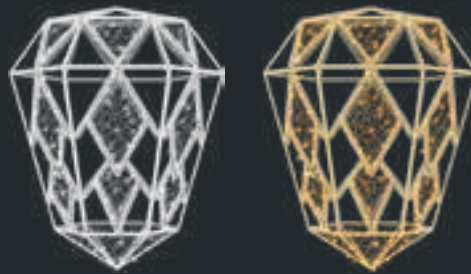

A

B

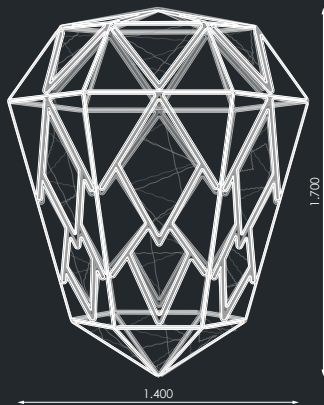

|        |      |           | 1                 | 2       |               |      |      |
|--------|------|-----------|-------------------|---------|---------------|------|------|
| 509626 | A    | flexi LED | STRING PLUS LED   | PVC NET |               |      |      |
| 509657 | B    | flexi LED | STRING PLUS LED   | PVC NET |               |      |      |
| W      | ⚡    | □         | ⊙                 | ⚖       | 📦             | 🍷    | 📏    |
| 304W   | 230V | CII       | IP65<br>IP44 Plug | 38kg    | 175x145x145cm | INC. | 10mm |



[GRÁFICOS: Unidades en mm/ GRAPHICS: Units in mm/ GRAPHIQUES: Unités en mm/ GRÁFICOS: Unidades em mm]

# Colección Toy

---

Cubes

Soldier

Doll

Train

Horse

3D Cubes

3D Soldier

3D Doll

3D Train

3D Horse





MADE IN SPAIN  
Desing by PRILUX

# Cubes

## Colección Toy



A

B

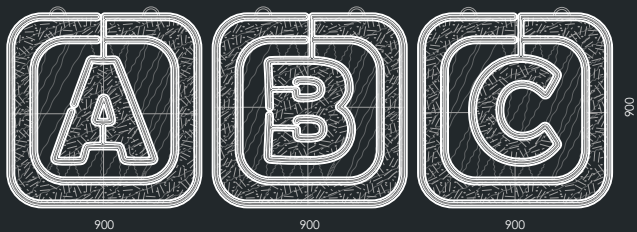

|        |      |          | 1                   | 2      | 3              |
|--------|------|----------|---------------------|--------|----------------|
| 509541 | A    | flexiLED | STRING PLUS LED LED | TAPIZ  | PVC NET        |
| 509565 | B    | flexiLED | STRING PLUS LED LED | TAPIZ  | PVC NET        |
| W      | ⚡    | □        | ⦿                   | ⚖      | 📦              |
| 125W   | 230V | CII      | IP65<br>IP44 Plug   | 21,5kg | (3x) 95x95x5cm |
|        |      |          |                     |        | INC. 10mm      |

[GRÁFICOS: Unidades en mm/ GRAPHICS: Units in mm/ GRAPHIQUES: Units in mm/ GRÁFICOS: Unidades em mm]



# Soldier

## Colección Toy



MADE IN SPAIN  
Desing by PRILUX

Motivo  
Motifs  
Motifs  
Motivos

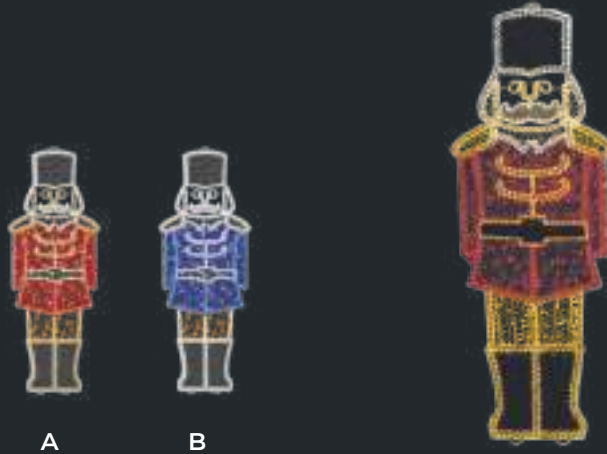

A

B



|        |      |           | 1                 | 2      | 3          |      |      |
|--------|------|-----------|-------------------|--------|------------|------|------|
| 509435 | A    | flexi LED | STRING LED        | TAPIZ  | PVC NET    |      |      |
| 509466 | B    | flexi LED | STRING LED        | TAPIZ  | PVC NET    |      |      |
| W      | ⚡    | □         | ⊙                 | Ⓚ      | 📦          | 🍷    | 📏    |
| 98W    | 230V | CII       | IP65<br>IP44 Plug | 10,5kg | 216x85x5cm | INC. | 10mm |

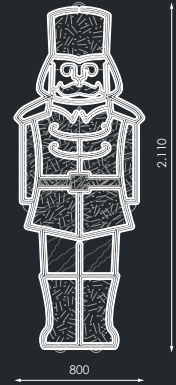

# Doll

## Colección Toy



MADE IN SPAIN  
Desing by PRILUX

Motivo  
Motifs  
Motifs  
Motivos

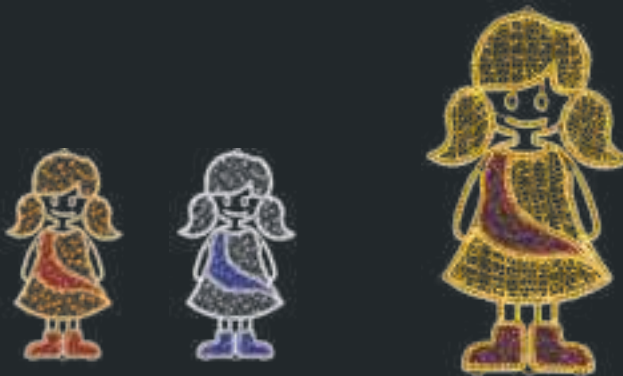

A

B



|        |      |           | 1                 | 2     | 3           |      |      |
|--------|------|-----------|-------------------|-------|-------------|------|------|
| 509589 | A    | flexi LED | STRING LED        | TAPIZ | PVC NET     |      |      |
| 509602 | B    | flexi LED | STRING LED        | TAPIZ | PVC NET     |      |      |
| W      | ⚡    | □         | ⊙                 | Ⓚ     | 📦           | 🍷    | 📏    |
| 92W    | 230V | CII       | IP65<br>IP44 Plug | 9,5kg | 185x106x5cm | INC. | 10mm |

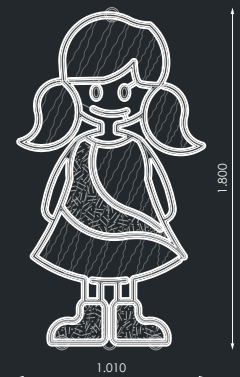



CC. La Abadía  
Toledo



CC. La Abadía  
Toledo

[GRÁFICOS: Unidades en mm/ GRÁFICOS: Units in mm/GRÁFICOS: Unidades en mm/GRÁFICOS: Unidades en mm]





La Almazara  
Illescas (Toledo)



Gavá  
Barcelona



MADE IN SPAIN  
Desing by PRILUX

# Train

## Colección Toy

**Motivo**  
 Motifs  
 Motifs  
 Motivos



A

B

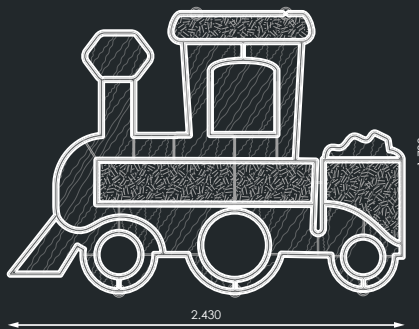

|        |   |          | 1      | 2           | 3             |
|--------|---|----------|--------|-------------|---------------|
| 509480 | A | flexiLED | STRING | LED LED LED | TAPIZ PVC NET |
| 509527 | B | flexiLED | STRING | LED LED LED | TAPIZ PVC NET |

|      |      |     |                   |      |             |      |      |
|------|------|-----|-------------------|------|-------------|------|------|
| W    | ⚡    | □   | ⊙                 | Ⓚ    | 📦           | 🔌    | 📏    |
| 166W | 230V | CII | IP65<br>IP44 Plug | 18kg | 248x178x5cm | INC. | 10mm |

[GRÁFICOS: Unidades en mm/ GRAPHICS: Units in mm/ GRAPHIQUES: Unités en mm/ GRÁFICOS: Unidades em mm]



MADE IN SPAIN  
Desing by PRILUX

# Horse

## Colección Toy

**Motivo**  
 Motifs  
 Motifs  
 Motivos



A

B

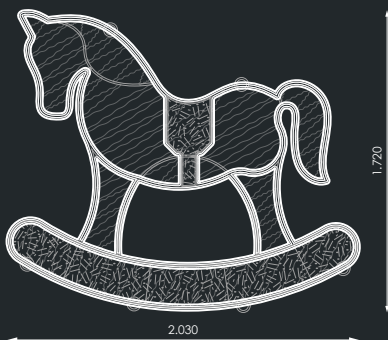

|        |   |          | 1      | 2           | 3             |
|--------|---|----------|--------|-------------|---------------|
| 509398 | A | flexiLED | STRING | LED LED LED | TAPIZ PVC NET |
| 509428 | B | flexiLED | STRING | LED LED LED | TAPIZ PVC NET |

|      |      |     |                   |      |             |      |      |
|------|------|-----|-------------------|------|-------------|------|------|
| W    | ⚡    | □   | ⊙                 | Ⓚ    | 📦           | 🔌    | 📏    |
| 108W | 230V | CII | IP65<br>IP44 Plug | 13kg | 208x177x5cm | INC. | 10mm |





La Almazara  
Illescas (Toledo)



La Almazara  
Illescas (Toledo)





MADE IN SPAIN  
Desing by PRILUX

# 3D Cubes

## Colección Toy

3D Motivo  
Motifs  
Motifs  
Motivos



A



B

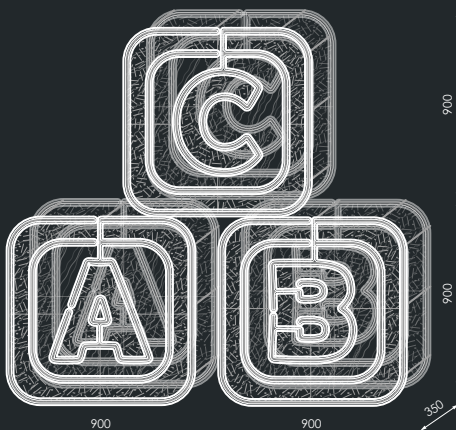

|        |     |          | 1                   | 2      | 3               |
|--------|-----|----------|---------------------|--------|-----------------|
| 509534 | A   | flexiLED | STRING PLUS LED LED | TAPIZ  | PVC NET         |
| 509558 | B   | flexiLED | STRING PLUS LED LED | TAPIZ  | PVC NET         |
| W      | ⚡   | ⚠        | ⊙                   | ⚖      | 📦               |
| 195W   | 24V | CIII     | IP65<br>IP44 Plug   | 50,5kg | (3x) 95x95x40cm |
|        |     |          |                     |        | INC. 10mm       |

[GRÁFICOS: Unidades en mm/ GRAPHICS: Units in mm/ GRAPHIQUES: Unités en mm/ GRÁFICOS: Unidades em mm]

# 3D Soldier

## Colección Toy



MADE IN SPAIN  
Desing by PRILUX

Motivo  
Motifs  
Motifs  
Motivos

3D



A



B

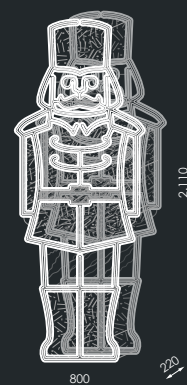

2.110

800

220

|        |     |               | 1                 | 2     | 3           |      |      |
|--------|-----|---------------|-------------------|-------|-------------|------|------|
| 509459 | A   | flexi LED LED | STRING LED LED    | TAPIZ | PVC NET     |      |      |
| 509442 | B   | flexi LED     | STRING LED LED    | TAPIZ | PVC NET     |      |      |
| W      | ⚡   | ⚡             | ⚡                 | ⚡     | ⚡           | ⚡    | ⚡    |
| 110W   | 24V | CIII          | IP65<br>IP44 Plug | 23kg  | 216x85x27cm | INC. | 10mm |

# 3D Doll

## Colección Toy



MADE IN SPAIN  
Desing by PRILUX

Motivo  
Motifs  
Motifs  
Motivos

3D



A



B



1.800

1.010

220

|        |     |           | 1                 | 2     | 3            |      |      |
|--------|-----|-----------|-------------------|-------|--------------|------|------|
| 509572 | A   | flexi LED | STRING LED LED    | TAPIZ | PVC NET      |      |      |
| 509596 | B   | flexi LED | STRING LED LED    | TAPIZ | PVC NET      |      |      |
| W      | ⚡   | ⚡         | ⚡                 | ⚡     | ⚡            | ⚡    | ⚡    |
| 110W   | 24V | CIII      | IP65<br>IP44 Plug | 21kg  | 185x106x27cm | INC. | 10mm |



MADE IN SPAIN  
Desing by PRILUX

# 3D Train Colección Toy

3D Motivo  
Motifs  
Motifs  
Motivos



A

B

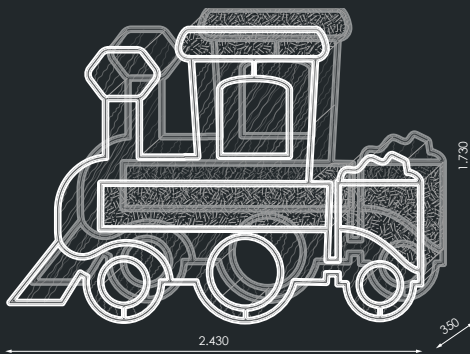

|        |   |           | 1                  | 2     | 3       |
|--------|---|-----------|--------------------|-------|---------|
| 509473 | A | flexi LED | STRING LED LED LED | TAPIZ | PVC NET |
| 509510 | B | flexi LED | STRING LED LED LED | TAPIZ | PVC NET |

|      |     |      |                   |      |              |      |      |
|------|-----|------|-------------------|------|--------------|------|------|
| W    | ⚡   | ⚠    | ⦿                 | ⚖    | 📦            | 🔌    | 📏    |
| 230W | 24V | CIII | IP65<br>IP44 Plug | 37kg | 248x178x40cm | INC. | 10mm |



MADE IN SPAIN  
Desing by PRILUX

# 3D Horse Colección Toy

3D Motivo  
Motifs  
Motifs  
Motivos



A

B

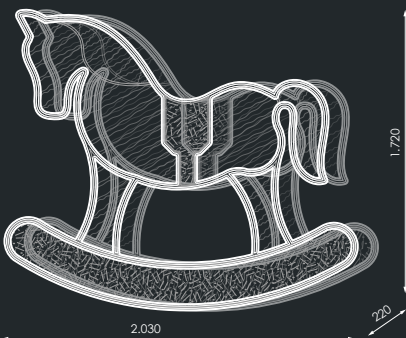

|        |   |           | 1                  | 2     | 3       |
|--------|---|-----------|--------------------|-------|---------|
| 509381 | A | flexi LED | STRING LED LED LED | TAPIZ | PVC NET |
| 509404 | B | flexi LED | STRING LED LED LED | TAPIZ | PVC NET |

|      |     |      |                   |      |              |      |      |
|------|-----|------|-------------------|------|--------------|------|------|
| W    | ⚡   | ⚠    | ⦿                 | ⚖    | 📦            | 🔌    | 📏    |
| 150W | 24V | CIII | IP65<br>IP44 Plug | 30kg | 208x177x27cm | INC. | 10mm |

[GRÁFICOS: Unidades en mm/ GRAPHICS: Units in mm/ GRAPHIQUES: Unités en mm/ GRÁFICOS: Unidades em mm]

# Colección Curly

---

Bird

Star

Ball

Small Butterfly

Ball 3D

Cone 3D

Hoop 3D

Hoop 3D Screenshot

Medusa

Papyre





MADE IN SPAIN  
Desing by PRILUX

# Bird

## Colección Curly

**Motivo**  
 Motifs  
 Motifs  
 Motivos



A



B



C



|        |   | W             |
|--------|---|---------------|
| 480338 | A | flexiLED 130W |
| 480383 | B | flexiLED 130W |
| 478694 | C | flexiLED 184W |

|      |     |                   |      |             |      |      |
|------|-----|-------------------|------|-------------|------|------|
|      |     |                   |      |             |      |      |
| 230V | CII | IP65<br>IP44 Plug | 11kg | 160x300x6cm | INC. | 10mm |

[GRÁFICOS: Unidades en mm/ GRAPHICS: Units in mm/ GRAPHIQUES: Unités en mm/ GRÁFICOS: Unidades em mm]



# Star

## Colección Curly



MADE IN SPAIN  
Desing by PRILUX

Motivo  
Motifs  
Motifs  
Motivos



A



B



C



| Barcode | Model | LED Type  | Power (W) |
|---------|-------|-----------|-----------|
| 480345  | A     | flexi LED | 100W      |
| 480390  | B     | flexi LED | 100W      |
| 478700  | C     | flexi LED | 142,6W    |

|      |     |                   |     |             |      |      |
|------|-----|-------------------|-----|-------------|------|------|
| ⚡    | □   | ⦿                 | ⚖   | 📦           | 🔌    | 📏    |
| 230V | CII | IP65<br>IP44 Plug | 8kg | 210x210x6cm | INC. | 10mm |





MADE IN SPAIN  
Desing by PRILUX

# Ball

## Colección Curly



**Motivo**  
 Motifs  
 Motifs  
 Motivos



A







B









C



|  |    | W    |
|---|---|------|
| 480352  | A  | 130W |
| 480406  | B  | 130W |
| 478717  | C  | 184W |

|   |   |   |   |   |   |   |
|---|---|---|---|---|---|---|
|  |  |  |  |  |  |  |
| 230V  | CII   | IP65<br>IP44 Plug   | 11kg  | 220x205x6cm   | INC.  | 10mm  |

[GRÁFICOS: Unidades en mm/ GRAPHICS: Units in mm/ GRAPHIQUES: Unités en mm/ GRÁFICOS: Unidades en mm]

# Small Butterfly

## Colección Curly



MADE IN SPAIN  
Desing by PRILUX

Motivo  
Motifs  
Motifs  
Motivos



A



B



C



| Barcode | Model | LED Type  | Power (W) |
|---------|-------|-----------|-----------|
| 480321  | A     | flexi LED | 105W      |
| 480376  | B     | flexi LED | 105W      |
| 478687  | C     | flexi LED | 151,8W    |

|      |     |                   |     |             |      |      |
|------|-----|-------------------|-----|-------------|------|------|
|      |     |                   |     |             |      |      |
| 230V | CII | IP65<br>IP44 Plug | 9kg | 190x160x6cm | INC. | 10mm |









# Ball 3D

## Colección Curly



MADE IN SPAIN  
Desing by PRILUX

Motivo  
Motifs  
Motifs  
Motivos

3D



A



B



C



|        |   |           | W    |
|--------|---|-----------|------|
| 509701 | A | flexi LED | 219W |
| 509749 | B | flexi LED | 219W |
| 512084 | C | flexi LED | 336W |

|      |     |                   |        |                                      |      |      |
|------|-----|-------------------|--------|--------------------------------------|------|------|
|      |     |                   |        |                                      |      |      |
| 230V | CII | IP65<br>IP44 Plug | 20,5kg | (2x) 135x135x70cm<br>(1x) 129x58x7cm | INC. | 10mm |







MADE IN SPAIN  
Desing by PRILUX

# Cone 3D

## Colección Curly

3D Motivo  
Motifs  
Motifs  
Motivos

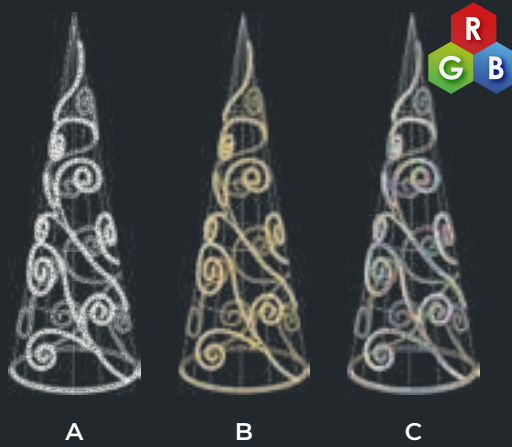

| Barcode | Model | LED Type  | Power (W) | Voltage |
|---------|-------|-----------|-----------|---------|
| 509671  | A     | flexi LED | 100W      | 24V     |
| 509718  | B     | flexi LED | 100W      | 24V     |
| 512053  | C     | flexi LED | 317W      | 230V    |

|              |                   |              |               |            |              |
|--------------|-------------------|--------------|---------------|------------|--------------|
| Icon: Square | Icon: Plug        | Icon: Weight | Icon: Box     | Icon: Plug | Icon: Square |
| CI           | IP65<br>IP44 Plug | 19kg         | 255x105x105cm | INC.       | 10mm         |

[GRÁFICOS: Unidades en mm/ GRAPHICS: Units in mm/ GRAPHIQUES: Unités en mm/ GRÁFICOS: Unidades en mm]

# Hoop 3D

## Colección Curly



MADE IN SPAIN  
Desing by PRILUX

Motivo  
Motifs  
Motifs  
Motivos

3D



A



B



C



|        |   |           | W    |
|--------|---|-----------|------|
| 509688 | A | flexi LED | 162W |
| 509725 | B | flexi LED | 162W |
| 512060 | C | flexi LED | 248W |

|      |     |                   |      |              |      |      |
|------|-----|-------------------|------|--------------|------|------|
|      |     |                   |      |              |      |      |
| 230V | CII | IP65<br>IP44 Plug | 21kg | 130x130x65cm | INC. | 10mm |

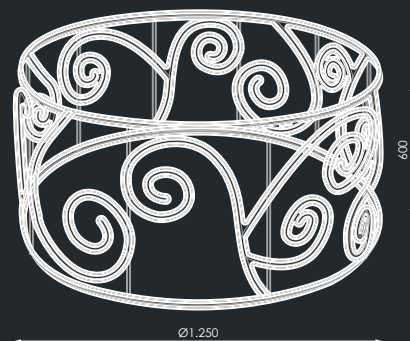



MADE IN SPAIN  
Desing by PRILUX

# Hoop 3D Screenlight

## Colección Curly

3D Motivo  
Motifs  
Motifs  
Motivos



A



B

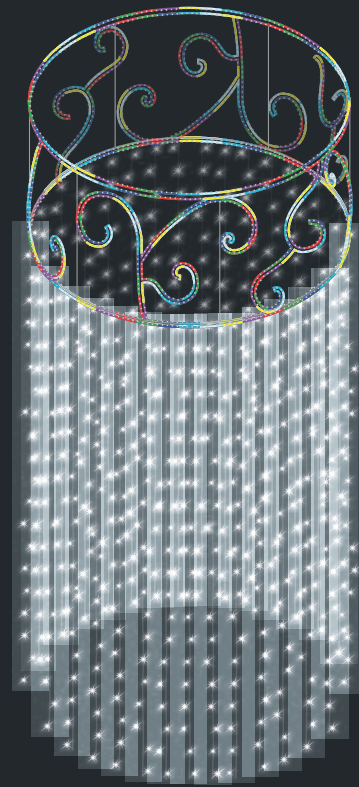

C



|        |   |           |                 | W    |
|--------|---|-----------|-----------------|------|
| 509695 | A | flexi LED | SCREENLIGHT LED | 204W |
| 509732 | B | flexi LED | SCREENLIGHT LED | 204W |
| 512077 | C | flexi LED | SCREENLIGHT LED | 290W |

|      |     |                   |        |              |      |      |
|------|-----|-------------------|--------|--------------|------|------|
| ⚡    | □   | ⊙                 | ⚖      | 📦            | ⏏    | 📏    |
| 230V | CII | IP65<br>IP44 Plug | 21,5kg | 130x130x65cm | INC. | 10mm |

[GRÁFICOS: Unidades en mm/ GRAPHICS: Units in mm/ GRAPHIQUES: Unités en mm/ GRÁFICOS: Unidades en mm]

# Medusa

## Colección Curly



MADE IN SPAIN  
Desing by PRILUX

Motivo  
Motifs  
Motifs  
Motivos

3D



A



B

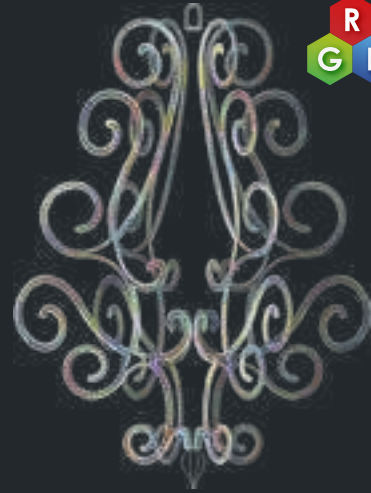

C



|        |   |          |   | W    |
|--------|---|----------|---|------|
| 446662 | A | flexiLED | 4 | 328W |
| 446679 | B | flexiLED | 4 | 328W |
| 510639 | C | flexiLED | 4 | 448W |

| 230V | CII | IP65<br>IP44 Plug | 30kg | (2x) 236x115x5cm<br>(1x) 30x30x30cm | INC. |  |
|------|-----|-------------------|------|-------------------------------------|------|--|

|        |   |          |   | W    |
|--------|---|----------|---|------|
| 446709 | A | flexiLED | 8 | 656W |
| 446716 | B | flexiLED | 8 | 656W |
| 510653 | C | flexiLED | 8 | 853W |

| 230V | CII | IP65<br>IP44 Plug | 48kg | (4x) 236x115x9cm<br>(1x) 30x30x30cm | INC. |  |
|------|-----|-------------------|------|-------------------------------------|------|--|

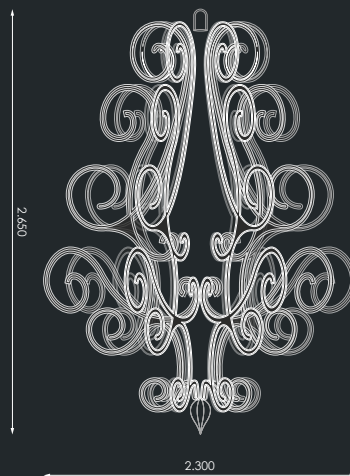





MADE IN SPAIN  
Desing by PRILUX

# Papyre

## Colección Curly

3D Motivo  
Motifs  
Motifs  
Motivos

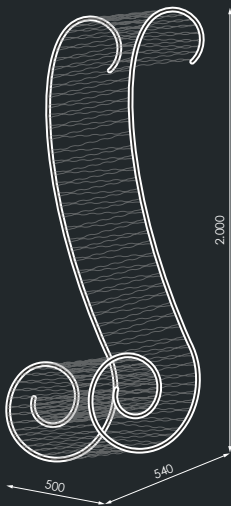

|        |           |                 |                   |     |             |      |
|--------|-----------|-----------------|-------------------|-----|-------------|------|
|        |           |                 |                   |     |             |      |
| 446099 | flexi LED | STRING PLUS LED |                   |     |             |      |
| 446105 | flexi LED | STRING PLUS LED |                   |     |             |      |
| W      |           |                 |                   |     |             |      |
| 44W    | 230V      | CII             | IP65<br>IP44 Plug | 7kg | 200x54x50cm | INC. |

[GRÁFICOS: Unidades en mm/ GRAPHICS: Units in mm/ GRAPHIQUES: Unités en mm/ GRÁFICOS: Unidades en mm]

# Colección Fantasy

---

Big Ball

Small Ball

Big Star

Small Star

Big Star 3D

Small Star 3D

Naida



MADE IN SPAIN  
Desing by PRILUX

# Big Ball

## Colección Fantasy

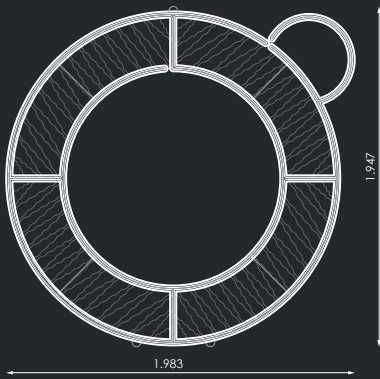
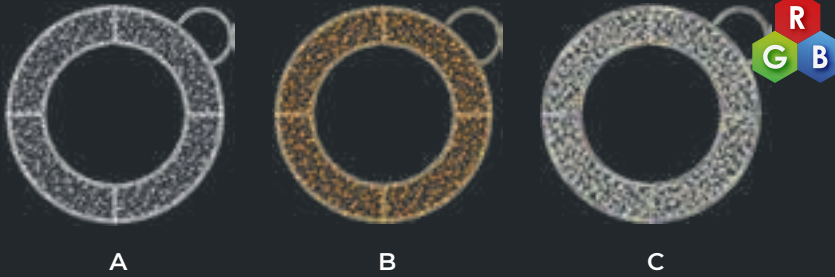

|        |   |          | 1               | 2       | W    |
|--------|---|----------|-----------------|---------|------|
| 479332 | A | flexiLED | STRING PLUS LED | PVC NET | 108W |
| 479370 | B | flexiLED | STRING PLUS LED | PVC NET | 108W |
| 479417 | C | flexiLED | STRING PLUS LED | PVC NET | 150W |

|      |     |                   |      |             |      |      |
|------|-----|-------------------|------|-------------|------|------|
|      |     |                   |      |             |      |      |
| 230V | CII | IP65<br>IP44 Plug | 16kg | 200x200x6cm | INC. | 10mm |



MADE IN SPAIN  
Desing by PRILUX

# Small Ball

## Colección Fantasy

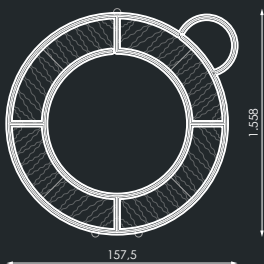

|        |   |          | 1               | 2       | W    |
|--------|---|----------|-----------------|---------|------|
| 479349 | A | flexiLED | STRING PLUS LED | PVC NET | 84W  |
| 479387 | B | flexiLED | STRING PLUS LED | PVC NET | 84W  |
| 479424 | C | flexiLED | STRING PLUS LED | PVC NET | 117W |

|      |     |                   |      |             |      |      |
|------|-----|-------------------|------|-------------|------|------|
|      |     |                   |      |             |      |      |
| 230V | CII | IP65<br>IP44 Plug | 11kg | 160x160x6cm | INC. | 10mm |

[GRÁFICOS: Unidades en mm/ GRAPHICS: Units in mm/ GRAPHIQUES: Unités en mm/ GRÁFICOS: Unidades en mm]





C.C. El Rosal  
León





MADE IN SPAIN  
Desing by PRILUX

# Big Star

## Colección Fantasy



Home icon, list icon, and text: Motivo, Motifs, Motifs, Motivos



|        |   | 1        | 2               | W            |
|--------|---|----------|-----------------|--------------|
| 479356 | A | flexiLED | STRING PLUS LED | PVC NET 148W |
| 479394 | B | flexiLED | STRING PLUS LED | PVC NET 148W |
| 479431 | C | flexiLED | STRING PLUS LED | PVC NET 206W |

|      |     |                   |      |             |      |      |
|------|-----|-------------------|------|-------------|------|------|
| ⚡    | □   | ⦿                 | ⚖    | 📦           | 🔌    | 📏    |
| 230V | CII | IP65<br>IP44 Plug | 21kg | 260x260x6cm | INC. | 10mm |



MADE IN SPAIN  
Desing by PRILUX

# Small Star

## Colección Fantasy



Home icon, list icon, and text: Motivo, Motifs, Motifs, Motivos



|        |   | 1        | 2               | W            |
|--------|---|----------|-----------------|--------------|
| 479363 | A | flexiLED | STRING PLUS LED | PVC NET 82W  |
| 479400 | B | flexiLED | STRING PLUS LED | PVC NET 82W  |
| 479448 | C | flexiLED | STRING PLUS LED | PVC NET 118W |

|      |     |                   |      |             |      |      |
|------|-----|-------------------|------|-------------|------|------|
| ⚡    | □   | ⦿                 | ⚖    | 📦           | 🔌    | 📏    |
| 230V | CII | IP65<br>IP44 Plug | 11kg | 170x170x6cm | INC. | 10mm |

[GRÁFICOS: Unidades en mm/ GRAPHICS: Units in mm/GRÁFICOS: Unités en mm/GRÁFICOS: Unidades en mm]

# Naida

## Colección Fantasy



MADE IN SPAIN  
Desing by PRILUX

Motivo  
Motifs  
Motifs  
Motivos

3D



A



B



|        |      | □         | ■                 |      |                                     |      |   |
|--------|------|-----------|-------------------|------|-------------------------------------|------|---|
| 446600 | A    | flexi LED | STRING PLUS LED   |      |                                     |      |   |
| 446617 | B    | flexi LED | STRING PLUS LED   |      |                                     |      |   |
| W      | ⚡    | □         | ⊙                 | ⊙    | ⊙                                   | ⊙    | ⊙ |
| 230W   | 230V | CII       | IP65<br>IP44 Plug | 40kg | (5x) 270x120x5cm<br>(1x) 30x30x30cm | INC. |   |

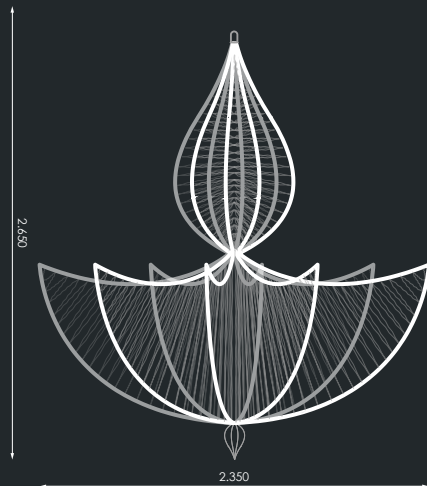



MADE IN SPAIN  
Desing by PRILUX

# Small Star 3D

## Colección Fantasy

3D Motivo  
Motifs  
Motifs  
Motivos



A



B



C



D



|        |   |          | 1               | 2       |
|--------|---|----------|-----------------|---------|
| 565059 | A | flexiLED | STRING PLUS LED | PVC NET |
| 565073 | B | flexiLED | STRING PLUS LED | PVC NET |

| W    | ⚡    | □  | ⦿                 | ⚖    | 📦            | 🔌    | 📏    |
|------|------|----|-------------------|------|--------------|------|------|
| 176W | 230V | CI | IP65<br>IP44 Plug | 34kg | 170x170x25cm | INC. | 10mm |

| 563727 | C | flexiLED | STRING PLUS LED |  |
|--------|---|----------|-----------------|--|
| 565066 | D | flexiLED | STRING PLUS LED |  |

| W    | ⚡    | □  | ⦿                 | ⚖    | 📦            | 🔌    | 📏    |
|------|------|----|-------------------|------|--------------|------|------|
| 176W | 230V | CI | IP65<br>IP44 Plug | 31kg | 170x170x25cm | INC. | 10mm |

[GRÁFICOS: Unidades en mm/ GRAPHICS: Units in mm/ GRAPHIQUES: Unités en mm/ GRÁFICOS: Unidades em mm]





C.C. La Gavia  
Madrid





MADE IN SPAIN  
Desing by PRILUX

# Big Star 3D

## Colección Fantasy

3D Motivo  
Motifs  
Motifs  
Motivos

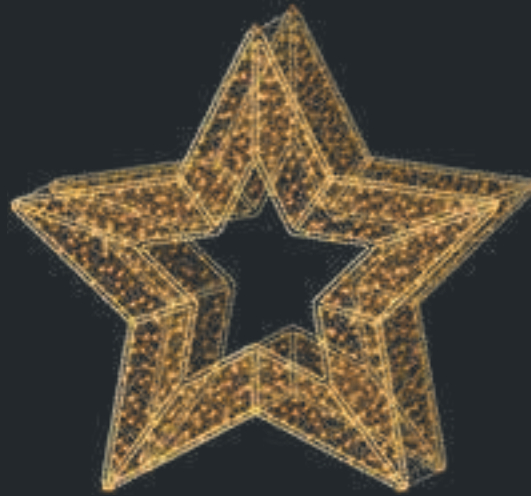

A



B



C



D

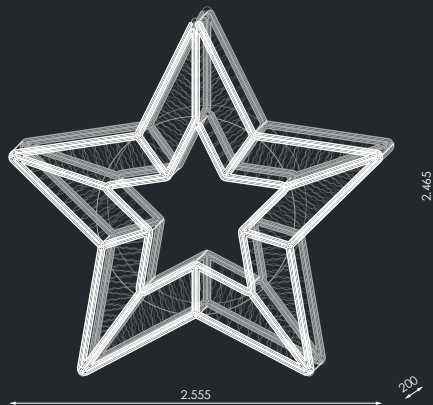

|        |   |          | 1               | 2       |
|--------|---|----------|-----------------|---------|
| 565028 | A | flexiLED | STRING PLUS LED | PVC NET |
| 565042 | B | flexiLED | STRING PLUS LED | PVC NET |

| W    | ⚡    | □  | ⦿                 | ⚖    | 📦            | 🔌    | 📏    |
|------|------|----|-------------------|------|--------------|------|------|
| 290W | 230V | CI | IP65<br>IP44 Plug | 60kg | 260x260x25cm | INC. | 10mm |

| 563659 | C | flexiLED | STRING PLUS LED |  |
|--------|---|----------|-----------------|--|
| 565035 | D | flexiLED | STRING PLUS LED |  |

| W    | ⚡    | □  | ⦿                 | ⚖    | 📦            | 🔌    | 📏    |
|------|------|----|-------------------|------|--------------|------|------|
| 290W | 230V | CI | IP65<br>IP44 Plug | 56kg | 260x260x25cm | INC. | 10mm |

[GRÁFICOS: Unidades en mm/ GRAPHICS: Units in mm/ GRAPHIQUES: Unités en mm/ GRÁFICOS: Unidades em mm]

# Colección Edén

---

Okra

Silene

Nepenthes



MADE IN SPAIN  
Desing by PRILUX

# Okra

## Colección Edén

Motivo  
Motifs  
Motifs  
Motivos



A

B



|        |      |       |                   |     |           |      |      |
|--------|------|-------|-------------------|-----|-----------|------|------|
|        |      |       |                   |     |           |      |      |
| 544498 | A    | flexi | LED               | LED |           |      |      |
| 544504 | B    | flexi | LED               | LED |           |      |      |
| W      | ⚡    | □     | ⊙                 | ⚖   | 📦         | 🔌    | 📏    |
| 6W     | 230V | CII   | IP65<br>IP44 Plug | 1kg | 43x30x5cm | INC. | 10mm |

[GRÁFICOS: Unidades en mm/ GRAPHICS: Units in mm/GRÁFICOS: Unidades en mm/GRÁFICOS: Unidades en mm]



MADE IN SPAIN  
Desing by PRILUX

# Silene

## Colección Edén

Motivo  
Motifs  
Motifs  
Motivos

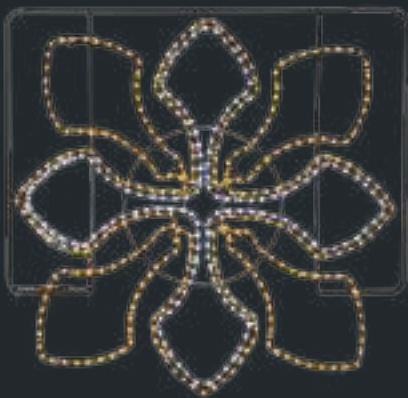

A

B

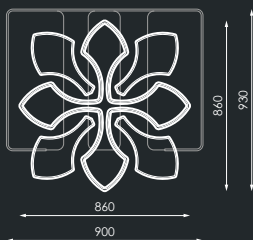

|        |      |       |                   |     |           |      |      |
|--------|------|-------|-------------------|-----|-----------|------|------|
|        |      |       |                   |     |           |      |      |
| 544436 | A    | flexi | LED               | LED |           |      |      |
| 544443 | B    | flexi | LED               | LED |           |      |      |
| W      | ⚡    | □     | ⊙                 | ⚖   | 📦         | 🔌    | 📏    |
| 36W    | 230V | CII   | IP65<br>IP44 Plug | 3kg | 97x95x5cm | INC. | 10mm |

# Nepenthes

## Colección Edén



MADE IN SPAIN  
Desing by PRILUX

Motivo  
Motifs  
Motifs  
Motivos

3D

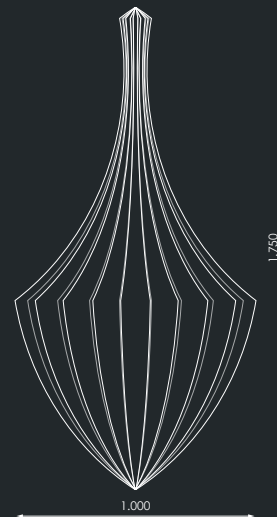
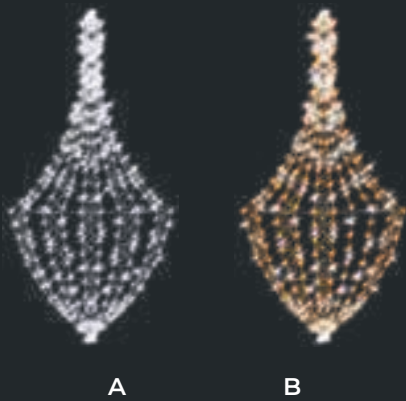
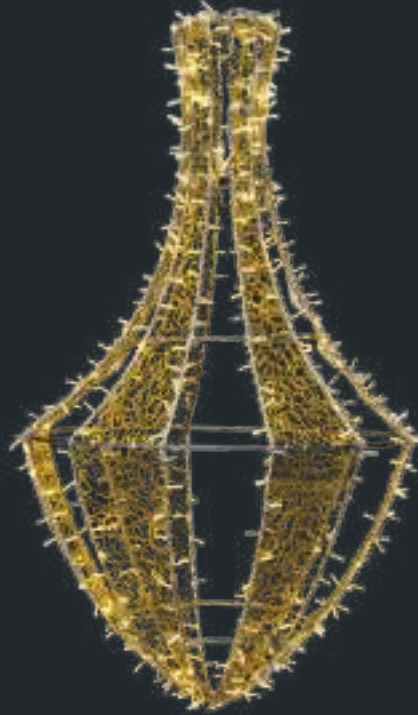

| 544832   | A                | STRING <b>PLUS</b> | PVC NET           |
|----------|------------------|--------------------|-------------------|
| 544849   | B                | STRING <b>PLUS</b> | PVC NET           |
| <b>W</b> |                  |                    |                   |
| 32W      | 230V             | CII                | IP65<br>IP44 Plug |
|          |                  |                    |                   |
| 10kg     | (2x) 180x55x55cm | INC.               |                   |

Bajo pedido / On request / Sur commande / A pedido



IP20





# Colección Helix

---

Abolone

Cingula

Mitra

Bolma

Obba





MADE IN SPAIN  
Desing by PRILUX

# Abolone

## Colección Helix

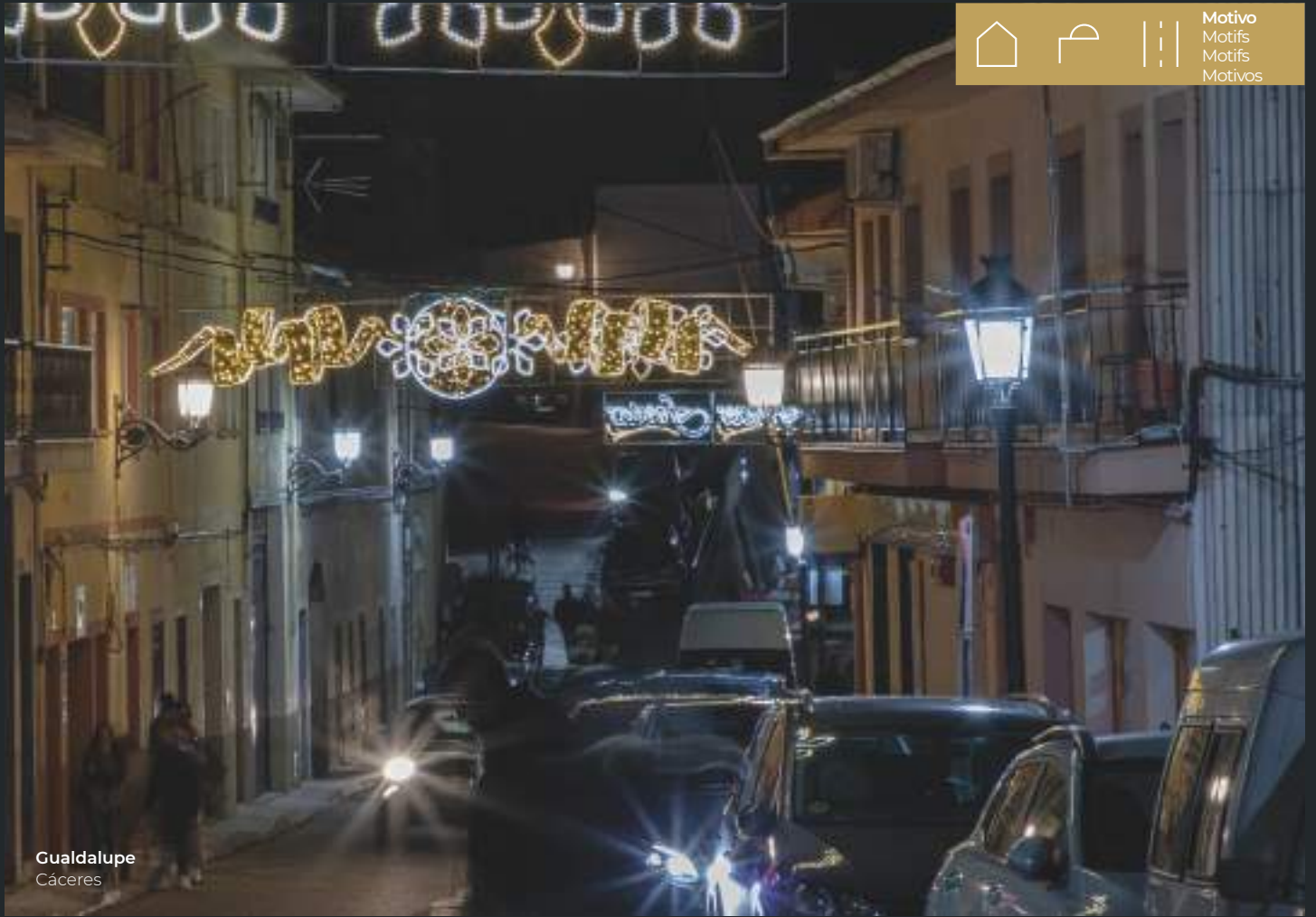

Gualdalupe  
Cáceres

[GRÁFICOS: Unidades en mm/ GRAPHICS: Units in mm/ GRAPHIQUES: Unités en mm/ GRÁFICOS: Unidades em mm]

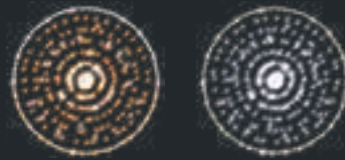

A

B

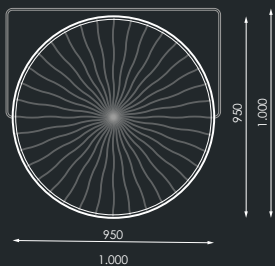

| 544993   | A    | <b>flexiLED</b> | STRING <b>PLUS</b> |
|----------|------|-----------------|--------------------|
| 545006   | B    | <b>flexiLED</b> | STRING <b>PLUS</b> |
| <b>W</b> |      |                 |                    |
| 25W      | 230V | CII             | IP65<br>IP44 Plug  |
|          |      |                 |                    |
|          |      | 3,5kg           | 105x105x5cm        |
|          |      |                 |                    |
|          |      |                 | INC. 10mm          |

# Cingula

## Colección Helix



MADE IN SPAIN  
Desing by PRILUX

Motivo  
Motifs  
Motifs  
Motivos



Gualdalupe  
Cáceres



| 545211 | A | flexi LED | STRING PLUS | LED |
|--------|---|-----------|-------------|-----|
| 545228 | B | flexi LED | STRING PLUS | LED |

|     |      |     |                   |       |             |      |      |
|-----|------|-----|-------------------|-------|-------------|------|------|
| W   | ⚡    | □   | ⊙                 | ⚖     | 📦           | 🔌    | 📏    |
| 44W | 230V | CII | IP65<br>IP44 Plug | 6,5kg | 240x110x5cm | INC. | 10mm |



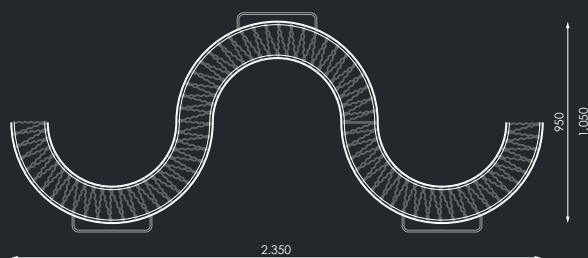



MADE IN SPAIN  
Desing by PRILUX

# Mitra

## Colección Helix

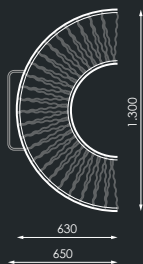
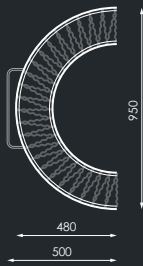

| 95cm |        |       |       |             |          |            |       |
|------|--------|-------|-------|-------------|----------|------------|-------|
| Icon | Code   | Label | Brand | Series      | LED Type | Beam Angle | Color |
|      | 544870 | A     | flexi | STRING PLUS | LED      |            |       |
|      | 544887 | B     | flexi | STRING PLUS | LED      |            |       |
|      | 544894 | C     | flexi | STRING PLUS | LED      |            |       |
|      | 544900 | D     | flexi | STRING PLUS | LED      |            |       |

| W   | ⚡    | □   | ⊙                 | ⚖   | 📦          | 🔌    | 📏    |
|-----|------|-----|-------------------|-----|------------|------|------|
| 17W | 230V | CII | IP65<br>IP44 Plug | 2kg | 100x55x5cm | INC. | 10mm |

| 130cm |        |       |       |             |          |            |       |
|-------|--------|-------|-------|-------------|----------|------------|-------|
| Icon  | Code   | Label | Brand | Series      | LED Type | Beam Angle | Color |
|       | 544931 | E     | flexi | STRING PLUS | LED      |            |       |
|       | 544948 | F     | flexi | STRING PLUS | LED      |            |       |
|       | 544955 | G     | flexi | STRING PLUS | LED      |            |       |
|       | 544962 | H     | flexi | STRING PLUS | LED      |            |       |

| W   | ⚡    | □   | ⊙                 | ⚖   | 📦          | 🔌    | 📏    |
|-----|------|-----|-------------------|-----|------------|------|------|
| 28W | 230V | CII | IP65<br>IP44 Plug | 4kg | 135x70x5cm | INC. | 10mm |

[GRÁFICOS: Unidades en mm/ GRÁFICOS: Units in mm/GRAPHIQUES: Unités en mm/GRÁFICOS: Unidades em mm]

# Bolma

## Colección Helix

Motivo  
Motifs  
Motifs  
Motivos

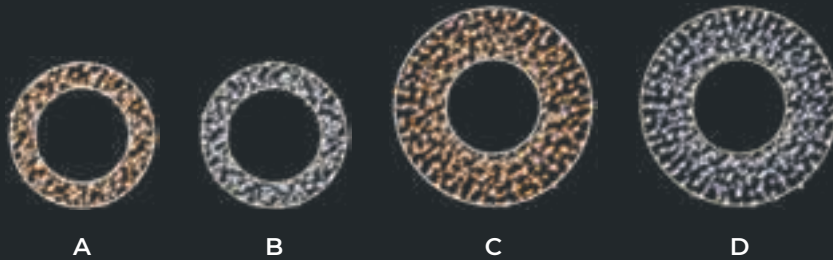

|        |      |           |                   |     |             |      |      |
|--------|------|-----------|-------------------|-----|-------------|------|------|
| 95cm   |      |           |                   |     |             |      |      |
|        |      |           |                   |     |             |      |      |
| 545099 | A    | flexi LED | STRING PLUS       |     |             |      |      |
| 545105 | B    | flexi LED | STRING PLUS       |     |             |      |      |
| W      |      |           |                   |     |             |      |      |
| 30W    | 230V | CII       | IP65<br>IP44 Plug | 3kg | 105x110x5cm | INC. | 10mm |

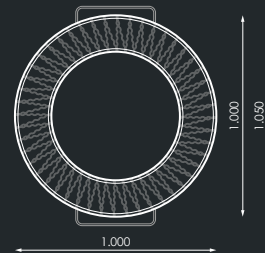

|        |      |           |                   |     |             |      |      |
|--------|------|-----------|-------------------|-----|-------------|------|------|
| 130cm  |      |           |                   |     |             |      |      |
|        |      |           |                   |     |             |      |      |
| 545150 | C    | flexi LED | STRING PLUS       |     |             |      |      |
| 545167 | D    | flexi LED | STRING PLUS       |     |             |      |      |
| W      |      |           |                   |     |             |      |      |
| 49W    | 230V | CII       | IP65<br>IP44 Plug | 6kg | 135x140x5cm | INC. | 10mm |

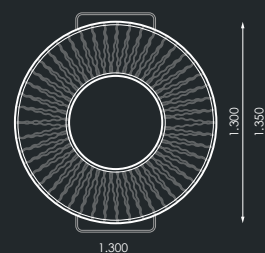



MADE IN SPAIN  
Desing by PRILUX

# Obba

## Colección Helix

3D Motivo  
Motifs  
Motifs  
Motivos

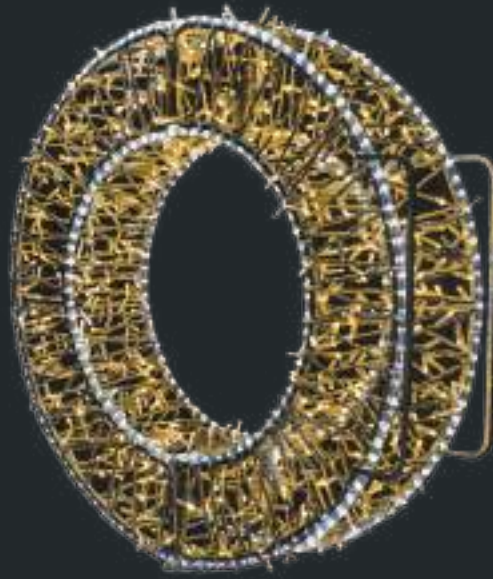

A



B

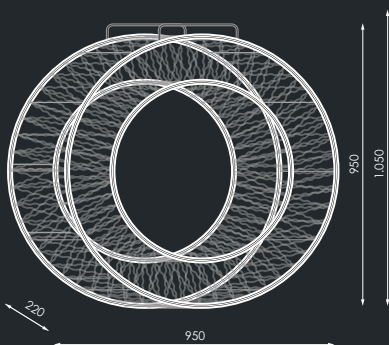

|        |              |          |                   |
|--------|--------------|----------|-------------------|
|        |              | 95cm     |                   |
|        |              |          |                   |
| 545273 | A            | flexiLED | STRING PLUS       |
| 545280 | B            | flexiLED | STRING PLUS       |
| W      |              |          |                   |
| 92W    | 230V         | CII      | IP65<br>IP44 Plug |
|        |              |          |                   |
| 10kg   | 110x100x27cm | INC.     | 10mm              |

[GRÁFICOS: Unidades en mm/ GRAPHICS: Units in mm/ GRAPHIQUES: Unités en mm/ GRÁFICOS: Unidades em mm]

# Felices Fiestas

Corporeo



MADE IN SPAIN  
Desing by PRILUX



| 200cm   |      |       |      |      |            |      |
|---------|------|-------|------|------|------------|------|
| Barcode | LED  | Color | W    | V    | Class      | IP   |
| 546201  | LED  | Gold  | 9W   | 230V | CII        | IP44 |
| 546218  | LED  | Red   | 9W   | 230V | CII        | IP44 |
| W       | V    | Class | IP   | kg   | Dimensions | INC. |
| 9W      | 230V | CII   | IP44 | 4kg  | 205x45x8cm | INC. |



| 400cm   |      |       |      |      |             |      |
|---------|------|-------|------|------|-------------|------|
| Barcode | LED  | Color | W    | V    | Class       | IP   |
| 546225  | LED  | Gold  | 15W  | 230V | CII         | IP44 |
| 546232  | LED  | Red   | 15W  | 230V | CII         | IP44 |
| W       | V    | Class | IP   | kg   | Dimensions  | INC. |
| 15W     | 230V | CII   | IP44 | 8kg  | 210x70x14cm | INC. |



## Información / Information / Information / Informações

Ñ/ Ideal para fachadas. Iluminación solo por la parte frontal.

E/ Ideal for facades. Lighting only from the front.

F/ Idéal pour les façades. Éclairage seulement de l'avant.

P/ Ideal para fachadas. Iluminação apenas pela frente.





MADE IN SPAIN  
Desing by PRILUX

# Feliz Navidad

## Corporeo



|        |      |     |      |     |            |      |
|--------|------|-----|------|-----|------------|------|
| 200cm  |      |     |      |     |            |      |
|        |      |     |      |     |            |      |
| 546140 |      |     |      |     |            |      |
| 546157 |      |     |      |     |            |      |
| W      |      |     |      |     |            |      |
| 9W     | 230V | CII | IP44 | 4kg | 205x45x8cm | INC. |

|        |      |     |      |     |             |      |
|--------|------|-----|------|-----|-------------|------|
| 400cm  |      |     |      |     |             |      |
|        |      |     |      |     |             |      |
| 546164 |      |     |      |     |             |      |
| 546171 |      |     |      |     |             |      |
| W      |      |     |      |     |             |      |
| 15W    | 230V | CII | IP44 | 8kg | 243x75x14cm | INC. |

### Información / Information / Information / Informações

Ñ/ Ideal para fachadas. Iluminación solo por la parte frontal.

E/ Ideal for facades. Lighting only from the front.

F/ Idéal pour les façades. Éclairage seulement de l'avant.

P/ Ideal para fachadas. Iluminação apenas pela frente.

[GRÁFICOS: Unidades en mm/ GRAPHICS: Units in mm/ GRÁFICOS: Unidades en mm/ GRÁFICOS: Unidades en mm]

Prilux te propone ser creativo.

Para ello se han diseñado una serie de motivos que te permiten combinar con otros motivos de nuestro catálogo. Fíjate en el símbolo que te indica con qué motivo puedes combinarlo, y..... CREA!!!

## EJEMPLOS DE COMPOSICIÓN

COMPOSITION EXAMPLE/EXEMPLES DE COMPOSITION/EXEMPLOS DE COMPOSIÇÃO



Prilux proposes you to be creative. To do this, a series of motifs have been designed that allow you to combine with other motifs in our catalog. Look at the symbol that tells you why you can combine it, and.....CREATE !!!

Prilux vous propose d'être créatif. Pour ce faire, une série de motifs a été conçue pour vous permettre de combiner avec d'autres motifs de notre catalogue. Regardez le symbole qui vous indique pourquoi vous pouvez le combiner, et.....CREATE !!!

Prilux propõe que você seja criativo. Para fazer isso, uma série de motivos foram projetados para combinar com outros motivos em nosso catálogo. Olhe para o símbolo que lhe diz porque você pode combiná-lo e.....CRIAR !!!



MADE IN SPAIN  
Desing by PRILUX

# Feliz Navidad

**Motivo**  
 Motifs  
 Motifs  
 Motivos

A *Feliz Navidad*

C *Feliz Navidad*

B *Feliz Navidad*

D *Feliz Navidad*



|        |   |       | W    |      |
|--------|---|-------|------|------|
| 545372 | A | flexi | 78W  | 17kg |
| 545389 | B | flexi | 78W  | 17kg |
| 489072 | C | flexi | 234W | 19kg |
| 489089 | D | flexi | 234W | 19kg |

|      |     |                   |              |      |      |
|------|-----|-------------------|--------------|------|------|
|      |     |                   |              |      |      |
| 230V | CII | IP65<br>IP44 Plug | 300x74x7,5cm | INC. | 10mm |



MADE IN SPAIN  
Desing by PRILUX

# Feliz Navidad Abetos

**Motivo**  
 Motifs  
 Motifs  
 Motivos

A *Feliz Navidad*

B *Feliz Navidad*



|        |   |       | W     |  |
|--------|---|-------|-------|--|
| 509848 | A | flexi | TAPIZ |  |
| 509855 | B | flexi | TAPIZ |  |

|      |      |     |                   |      |  |
|------|------|-----|-------------------|------|--|
|      |      |     |                   |      |  |
| 132W | 230V | CII | IP65<br>IP44 Plug | 16kg | (2x) 97x77x5cm<br>(2x) 30x32x5cm<br>(1x) 51x53x5cm<br>(1x) 99x33x5cm<br>(1x) 305x557x5cm |

[GRÁFICOS: Unidades en mm/ GRAPHICS: Units in mm/GRAPHIQUES: Unités en mm/GRÁFICOS: Unidades em mm]



# Feliz Navidad

8m



MADE IN SPAIN  
Desing by PRILUX



Ávila



|              |           |          |
|--------------|-----------|----------|
|              |           |          |
| 509800       | A         | flexiLED |
| 509817       | B         | flexiLED |
| W            |           |          |
| 267W         | 230V      | CII      |
|              |           |          |
| IP65         | IP44 Plug | 30kg     |
|              |           |          |
| 350x165x20cm | INC.      | 20mm     |

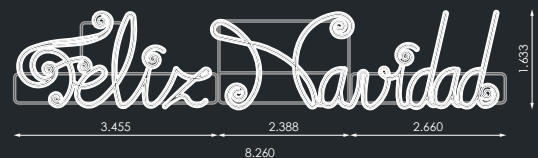





MADE IN SPAIN  
Desing by PRILUX

# Feliz Navidad

6m





**Motivo**  
 Motifs  
 Motifs  
 Motivos



[GRÁFICOS: Unidades en mm/ GRAPHICS: Units in mm/ GRAPHIQUES: Unités en mm/ GRÁFICOS: Unidades en mm]



|   |   |   |   |   |   |   |   |
|---|---|---|---|---|---|---|---|
|  |  |  |  |   |   |   |   |
| 567152  | flexi DOUBLE NEON   | flexi   | STRING PLUS   |   |   |   |   |
|  |    |   |  |  |  |  |  |
| 750,5W  | 230V  | CL  | IP65<br>IP44 Plug   | 27kg  | 300x200x20cm  | INC.  | 10x20mm   |

# Felices Fiestas



MADE IN SPAIN  
Desing by PRILUX

Motivo  
Motifs  
Motifs  
Motivos



| 545334 | A    | flexi LED |                   |     |            |      |      |
|--------|------|-----------|-------------------|-----|------------|------|------|
| 545341 | B    | flexi LED |                   |     |            |      |      |
| W      | ⚡    | □         | ⦿                 | ⚖   | 📦          | 🔌    | 📏    |
| 48W    | 230V | CII       | IP65<br>IP44 Plug | 7kg | 270x55x5cm | INC. | 10mm |



|        |     |                       |              | W    | ⚖    |
|--------|-----|-----------------------|--------------|------|------|
| 545358 | A   | flexi LED             |              | 96W  | 24kg |
| 545365 | B   | flexi LED             |              | 96W  | 24kg |
| 489096 | C   | flexi DOUBLE NEON LED |              | 288W | 26kg |
| 489102 | D   | flexi DOUBLE NEON LED |              | 288W | 26kg |
| ⚡      | □   | ⦿                     | 📦            | 🔌    | 📏    |
| 230V   | CII | IP65<br>IP44 Plug     | 275x95x7,5cm | INC. | 10mm |

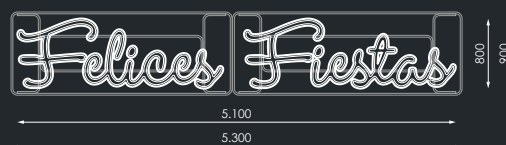



MADE IN SPAIN  
Desing by PRILUX

# Felices Fiestas

5m

N  
NEW

Motivo  
Motifs  
Motifs  
Motivos

# Felices Fiestas



|        |                   |     |                   |      |              |      |         |
|--------|-------------------|-----|-------------------|------|--------------|------|---------|
| 626569 | flexi DOUBLE NEON | LED | STRING PLUS       | LED  |              |      |         |
| W      | ⚡                 | □   | ⊙                 | ⚖    | 📦            | 🔌    | 📏       |
| 368W   | 230V              | CII | IP65<br>IP44 Plug | 38kg | 300x220x20cm | INC. | 10x20mm |



MADE IN SPAIN  
Desing by PRILUX

# Felices Fiestas

Estrellas 6m

Motivo  
Motifs  
Motifs  
Motivos

# ★ Felices Fiestas ★



|        |                   |     |                   |             |              |      |         |
|--------|-------------------|-----|-------------------|-------------|--------------|------|---------|
| 567169 | flexi DOUBLE NEON | LED | LED               | STRING PLUS | LED          |      |         |
| W      | ⚡                 | □   | ⊙                 | ⚖           | 📦            | 🔌    | 📏       |
| 368W   | 230V              | CII | IP65<br>IP44 Plug | 38kg        | 300x220x20cm | INC. | 10x20mm |

[GRÁFICOS: Unidades en mm/ GRAPHICS: Units in mm/ GRAPHIQUES: Unités en mm/ GRÁFICOS: Unidades en mm]

# Felices Fiestas

con Estrella de Mar



MADE IN SPAIN  
Desing by PRILUX

Motivo  
Motifs  
Motifs  
Motivos



|        | 1    | 2                 | T          |
|--------|------|-------------------|------------|
| 149358 | A    | flexiLED          | FLASH BULB |
| 149372 | B    | flexiLED          | FLASH BULB |
| W      | ⚡    | ⏏                 | ⚖          |
| 73W    | 230V | CII               | 8kg        |
|        |      | IP65<br>IP44 Plug | 270x83x5cm |
|        |      |                   | INC. 10mm  |



|        | 1    | 2                 | T             |
|--------|------|-------------------|---------------|
| 149365 | A    | flexiLED          | FLASH BULB    |
| 149389 | B    | flexiLED          | FLASH BULB    |
| W      | ⚡    | ⏏                 | ⚖             |
| 120W   | 230V | CII               | 26kg          |
|        |      | IP65<br>IP44 Plug | 275x173x7,5cm |
|        |      |                   | INC. 25mm     |







MADE IN SPAIN  
Desing by PRILUX

# Felices Fiestas con Estrellas y Bolas



**Motivo**  
 Motifs  
 Motifs  
 Motivos













[GRÁFICOS: Unidades en mm/ GRAPHICS: Units in mm/ GRAPHIQUES: Unités en mm/ GRÁFICOS: Unidades en mm]



|   |   |  |   |   |   |   |   |
|---|---|--|---|---|---|---|---|
|  |  |                 |   |   |   |   |   |
| 149396  | <b>flexiLED</b>   | CHRISTMAS BALL  |   |   |   |   |   |
| <b>W</b>  |    |                  |  |  |  |  |  |
| 57W   | 230V  | CII  | IP65<br>IP44 Plug   | 8kg   | 270x84x5cm  | INC.  | 10mm  |



|   |   |  |   |   |   |   |   |
|---|---|--|---|---|---|---|---|
|  |  |                 |   |   |   |   |   |
| 149402  | <b>flexiLED</b>   | CHRISTMAS BALL  |   |   |   |   |   |
| <b>W</b>  |    |                  |  |  |  |  |  |
| 116W  | 230V  | CII  | IP65<br>IP44 Plug   | 23kg  | 275x150x7,5cm   | INC.  | 25mm  |

# Felices Fiestas

## con Cometa



MADE IN SPAIN  
Desing by PRILUX

Motivo  
Motifs  
Motifs  
Motivos



Moralzarzal  
Madrid



|        |          |          |                   |     |            |      |      |
|--------|----------|----------|-------------------|-----|------------|------|------|
|        | 1        | 2        |                   |     |            |      |      |
| 149426 | flexiLED | flexiLED |                   |     |            |      |      |
| W      |          |          |                   |     |            |      |      |
| 78W    | 230V     | CII      | IP65<br>IP44 Plug | 8kg | 270x84x5cm | INC. | 10mm |



|        |          |          |                   |      |               |      |      |
|--------|----------|----------|-------------------|------|---------------|------|------|
|        | 1        | 2        |                   |      |               |      |      |
| 149419 | flexiLED | flexiLED |                   |      |               |      |      |
| W      |          |          |                   |      |               |      |      |
| 156W   | 230V     | CII      | IP65<br>IP44 Plug | 26kg | 275x173x7,5cm | INC. | 25mm |





MADE IN SPAIN  
Desing by PRILUX

# Felices Fiestas

Rama



|        |   | 1        | 2        |
|--------|---|----------|----------|
| 149488 | A | flexiLED | flexiLED |
| 149471 | B | flexiLED | flexiLED |

| W   | ⚡    | □   | ⊙                  | ⚖   | 📦          | 🔌    | 📏    |
|-----|------|-----|--------------------|-----|------------|------|------|
| 66W | 230V | CII | IP65<br>IP44, Plug | 4kg | 258x63x5cm | INC. | 10mm |

|        |   | 1        | 2        |
|--------|---|----------|----------|
| 149501 | A | flexiLED | flexiLED |
| 149495 | B | flexiLED | flexiLED |

| W    | ⚡    | □   | ⊙                  | ⚖    | 📦             | 🔌    | 📏    |
|------|------|-----|--------------------|------|---------------|------|------|
| 120W | 230V | CII | IP65<br>IP44, Plug | 18kg | 220x100x7,5cm | INC. | 25mm |

[GRÁFICOS: Unidades en mm/ GRAPHICS: Units in mm/ GRAPHIQUES: Unités en mm/ GRÁFICOS: Unidades en mm]

# Felices Fiestas



MADE IN SPAIN  
Desing by PRILUX



Motivo  
Motifs  
Motifs  
Motivos

Ayto. Zizur  
Pamplona



A *Felices Fiestas*

B *Felices Fiestas*

|        |            |     |                   |     |            |      |      |
|--------|------------|-----|-------------------|-----|------------|------|------|
|        |            |     |                   |     |            |      |      |
| 385046 | A flexiLED |     |                   |     |            |      |      |
| 094863 | B flexiLED |     |                   |     |            |      |      |
| W      |            |     |                   |     |            |      |      |
| 40W    | 230V       | CII | IP65<br>IP44 Plug | 4kg | 209x40x5cm | INC. | 10mm |



|        |            |     |                   |     |            |      |      |
|--------|------------|-----|-------------------|-----|------------|------|------|
|        |            |     |                   |     |            |      |      |
| 385053 | A flexiLED |     |                   |     |            |      |      |
| 094788 | B flexiLED |     |                   |     |            |      |      |
| W      |            |     |                   |     |            |      |      |
| 56W    | 230V       | CII | IP65<br>IP44 Plug | 8kg | 313x58x5cm | INC. | 25mm |







MADE IN SPAIN  
Desing by PRILUX

# Bones Festes con Cometa



**Motivo**  
 Motifs  
 Motifs  
 Motivos



|   |          |          |
|---|----------|----------|
|  | 1        | 2        |
| 385695  | flexiLED | flexiLED |

|     |   |  |   |   |   |   |   |
|-----|---|--|---|---|---|---|---|
| W   |  |  |  |  |  |  |  |
| 78W | 230V  | CII  | IP65<br>IP44 Plug   | 8kg   | 270x84x5cm  | INC.  | 10mm  |

|   |          |          |
|---|----------|----------|
|  | 1        | 2        |
| 385701  | flexiLED | flexiLED |

|      |   |  |   |   |   |   |   |
|------|---|--|---|---|---|---|---|
| W    |  |  |  |  |  |  |  |
| 156W | 230V  | CII  | IP65<br>IP44 Plug   | 26kg  | 264x173x7,5cm   | INC.  | 25mm  |

[GRÁFICOS: Unidades en mm/ GRAPHICS: Units in mm/ GRAPHIQUES: Unités en mm/ GRÁFICOS: Unidades en mm]

# Bones Festes

## Rama



MADE IN SPAIN  
Desing by PRILUX

Motivo  
Motifs  
Motifs  
Motivos



|        |   | 1         | 2         |
|--------|---|-----------|-----------|
| 385657 | A | flexi LED | flexi LED |
| 385664 | B | flexi LED | flexi LED |

|     |      |     |                   |     |            |      |      |
|-----|------|-----|-------------------|-----|------------|------|------|
| W   | ⚡    | ⏏   | ⦿                 | ⚖   | 📦          | 🍷    | 📏    |
| 62W | 230V | CII | IP65<br>IP44 Plug | 7kg | 260x63x5cm | INC. | 10mm |



|        |   | 1         | 2         |
|--------|---|-----------|-----------|
| 385671 | A | flexi LED | flexi LED |
| 385688 | B | flexi LED | flexi LED |

|      |      |     |                   |      |               |      |      |
|------|------|-----|-------------------|------|---------------|------|------|
| W    | ⚡    | ⏏   | ⦿                 | ⚖    | 📦             | 🍷    | 📏    |
| 100W | 230V | CII | IP65<br>IP44 Plug | 18kg | 220x100x7,5cm | INC. | 25mm |





MADE IN SPAIN  
Desing by PRILUX

# Bones Festes

## Freestyle



A *BONES FESTES*

B *BONES FESTES*



|        |   |
|--------|---|
|        |   |
| 385084 | A |
| 954273 | B |

|     |      |     |                   |     |            |      |      |
|-----|------|-----|-------------------|-----|------------|------|------|
| W   |      |     |                   |     |            |      |      |
| 66W | 230V | CII | IP65<br>IP44 Plug | 4kg | 270x50x5cm | INC. | 10mm |

|        |   |
|--------|---|
|        |   |
| 373821 | A |
| 954280 | B |

|     |      |     |                   |        |              |      |      |
|-----|------|-----|-------------------|--------|--------------|------|------|
| W   |      |     |                   |        |              |      |      |
| 90W | 230V | CII | IP65<br>IP44 Plug | 14,5kg | 213x70x7,5cm | INC. | 25mm |

[GRÁFICOS: Unidades en mm/ GRAPHICS: Units in mm/ GRAPHIQUES: Unités en mm/ GRÁFICOS: Unidades em mm]







MADE IN SPAIN  
Desing by PRILUX

# Boas Festas Freestyle



|        |             |     |                   |        |              |      |      |
|--------|-------------|-----|-------------------|--------|--------------|------|------|
|        | □           |     |                   |        |              |      |      |
| 385077 | A flexi LED |     |                   |        |              |      |      |
| 961578 | B flexi LED |     |                   |        |              |      |      |
| W      | ⚡           | □   | ⊙                 | ⚖      | 📦            | 🔌    | 📏    |
| 81W    | 230V        | CII | IP65<br>IP44 Plug | 13,5kg | 235x70x7,5cm | INC. | 25mm |



MADE IN SPAIN  
Desing by PRILUX

# Boas Festas 6m



|        |                         |     |                   |      |               |      |         |
|--------|-------------------------|-----|-------------------|------|---------------|------|---------|
|        | □                       |     |                   |      |               |      |         |
| 567176 | A flexi DOUBLE NEON LED |     |                   |      |               |      |         |
| 567183 | B flexi DOUBLE NEON LED |     |                   |      |               |      |         |
| W      | ⚡                       | □   | ⊙                 | ⚖    | 📦             | 🔌    | 📏       |
| 564W   | 230V                    | CII | IP65<br>IP44 Plug | 19kg | 390x130x7,5cm | INC. | 10x20mm |

[GRÁFICOS: Unidades en mm/ GRAPHICS: Units in mm/ GRAPHIQUES: Unités en mm/ GRÁFICOS: Unidades em mm]

# Zorionak

## Rama



MADE IN SPAIN  
Desing by PRILUX

Motivo  
Motifs  
Motifs  
Motivos



|        |   | 1         | 2         |
|--------|---|-----------|-----------|
| 385732 | A | flexi LED | flexi LED |
| 385749 | B | flexi LED | flexi LED |

|     |      |     |                   |      |             |      |      |
|-----|------|-----|-------------------|------|-------------|------|------|
| W   | ⚡    | □   | ⊙                 | ⚖    | 📦           | 🔌    | 📏    |
| 67W | 230V | CII | IP65<br>IP44 Plug | 10kg | 293x100x5cm | INC. | 10mm |





MADE IN SPAIN  
Desing by PRILUX



[GRÁFICOS: Unidades en mm/ GRAPHICS: Units in mm/ GRAPHIQUES: Unités en mm/ GRÁFICOS: Unidades em mm]



|        |   |                   |     |
|--------|---|-------------------|-----|
|        |   |                   |     |
| 489119 | A | flexi DOUBLE NEON | LED |
| 489126 | B | flexi DOUBLE NEON | LED |

|      |      |     |                   |      |            |      |      |
|------|------|-----|-------------------|------|------------|------|------|
| W    | ⚡    | □   | ⊙                 | ⚖    | 📦          | 🔌    | 📏    |
| 144W | 230V | CII | IP65<br>IP44 Plug | 18kg | 303x57x5cm | INC. | 25mm |

|        |   |       |     |
|--------|---|-------|-----|
|        |   |       |     |
| 544276 | C | flexi | LED |
| 544269 | D | flexi | LED |

|     |      |     |                   |      |              |      |      |
|-----|------|-----|-------------------|------|--------------|------|------|
| W   | ⚡    | □   | ⊙                 | ⚖    | 📦            | 🔌    | 📏    |
| 90W | 230V | CII | IP65<br>IP44 Plug | 16kg | 300x95x7,5cm | INC. | 25mm |

# Merry Christmas



MADE IN SPAIN  
Desing by PRILUX

Motivo  
Motifs  
Motifs  
Motivos

A Merry Christmas

B Merry Christmas



|        |              |          |                   |
|--------|--------------|----------|-------------------|
|        |              |          |                   |
| 545396 | A            | flexiLED |                   |
| 545402 | B            | flexiLED |                   |
| W      |              |          |                   |
| 60W    | 230V         | CII      | IP65<br>IP44 Plug |
|        |              |          |                   |
| 10kg   | 200x70x7,5cm | INC.     | 10mm              |



# Merry Christmas



MADE IN SPAIN  
Desing by PRILUX

Motivo  
Motifs  
Motifs  
Motivos

A Merry Christmas

B Merry Christmas



|        |              |          |                   |
|--------|--------------|----------|-------------------|
|        |              |          |                   |
| 509862 | A            | flexiLED |                   |
| 509879 | B            | flexiLED |                   |
| W      |              |          |                   |
| 111W   | 230V         | CII      | IP65<br>IP44 Plug |
|        |              |          |                   |
| 14,5kg | 256x115x10cm | INC.     | 10mm              |







MADE IN SPAIN  
Desing by PRILUX

# Bonnes Fêtes con Cometa



**Motivo**  
 Motifs  
 Motifs  
 Motivos

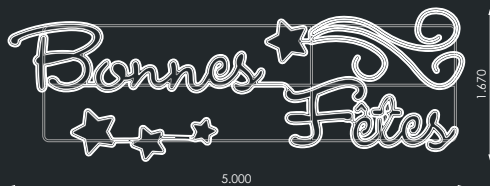

|   |          |          |
|---|----------|----------|
|  | 1        | 2        |
| 494885  | flexiLED | flexiLED |

|     |   |  |   |   |   |   |   |
|-----|---|--|---|---|---|---|---|
| W   |  |  |  |  |  |  |  |
| 81W | 230V  | CII  | IP65<br>IP44 Plug   | 8,5kg   | 277x907x7,5cm   | INC.  | 10mm  |

|   |          |          |
|---|----------|----------|
|  | 1        | 2        |
| 526159  | flexiLED | flexiLED |

|      |   |  |   |   |   |   |   |
|------|---|--|---|---|---|---|---|
| W    |  |  |  |  |  |  |  |
| 165W | 230V  | CII  | IP65<br>IP44 Plug   | 26kg  | 264x173x7,5cm   | INC.  | 10x20mm   |

[GRÁFICOS: Unidades en mm/ GRAPHICS: Units in mm/ GRAPHIQUES: Unités en mm/ GRÁFICOS: Unidades em mm]

# Bonne Année

## Rama



MADE IN SPAIN  
Desing by PRILUX

Motivo  
Motifs  
Motifs  
Motivos



Bonne Année



|        |          |          |                   |       |            |      |         |
|--------|----------|----------|-------------------|-------|------------|------|---------|
|        | 1        | 2        |                   |       |            |      |         |
| 526166 | flexiLED | flexiLED |                   |       |            |      |         |
| W      |          |          |                   |       |            |      |         |
| 69W    | 230V     | CII      | IP65<br>IP44 Plug | 7,5kg | 256x63x5cm | INC. | 20x10mm |



|        |          |          |                   |      |             |      |         |
|--------|----------|----------|-------------------|------|-------------|------|---------|
|        | 1        | 2        |                   |      |             |      |         |
| 528047 | flexiLED | flexiLED |                   |      |             |      |         |
| W      |          |          |                   |      |             |      |         |
| 102W   | 230V     | CII      | IP65<br>IP44 Plug | 12kg | 266x95x10cm | INC. | 20x10mm |





MADE IN SPAIN  
Desing by PRILUX

# Joyeux Noël



Motivo  
Motifs  
Motifs  
Motivos

[GRÁFICOS: Unidades en mm/ GRAPHICS: Units in mm/GRÁFICOS: Unidades en mm/GRÁFICOS: Unidades en mm]

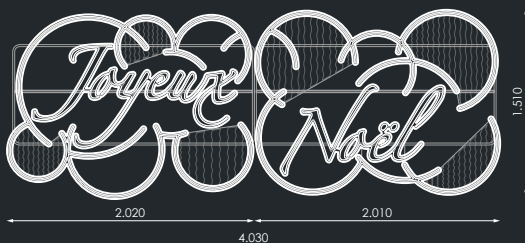

|        |               |          |                    |
|--------|---------------|----------|--------------------|
|        | 1             | 2        |                    |
| 526180 | flexiLED      | flexiLED | STRING PLUS        |
| W      |               |          |                    |
| 186W   | 230V          | CII      | IP65<br>IP44, Plug |
|        |               |          |                    |
| 23,5kg | 207x156x7,5cm | INC.     | 10mm               |

# Star Comet

550cm



MADE IN SPAIN  
Desing by PRILUX

Motivo  
Motifs  
Motifs  
Motivos

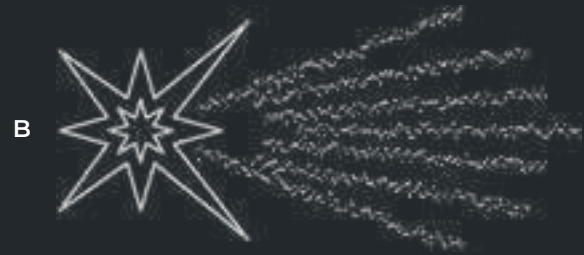

|        |   |                  | W    |
|--------|---|------------------|------|
| 392389 | A | flexi            | 236W |
| 392419 | B | flexi  / CLUSTER | 70W  |
| 392433 | C | flexi            | 178W |
| 392426 | D | flexi            | 178W |
| 488716 | E | flexi            | 280W |

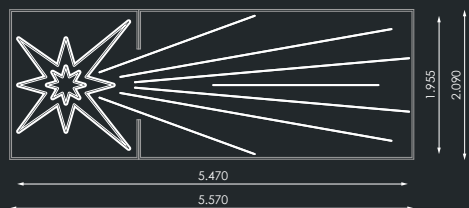

Cambio entre colores según función seleccionada.  
Switching between colors according to selected function.  
La commutation entre les couleurs en fonction de la fonction sélectionnée.  
Alternando entre as cores de acordo com a função selecionada.

|      |     |                   |      |                                  |      |      |
|------|-----|-------------------|------|----------------------------------|------|------|
|      |     |                   |      |                                  |      |      |
| 230V | CII | IP65<br>IP44 Plug | 25kg | 1- 362x204x6cm<br>2- 162x204x6cm | INC. | 25mm |





MADE IN SPAIN  
Desing by PRILUX

# Star Comet

700cm

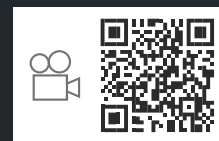
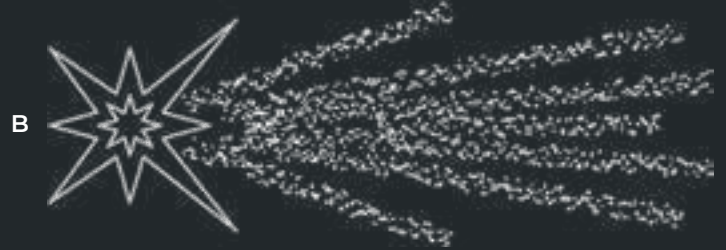
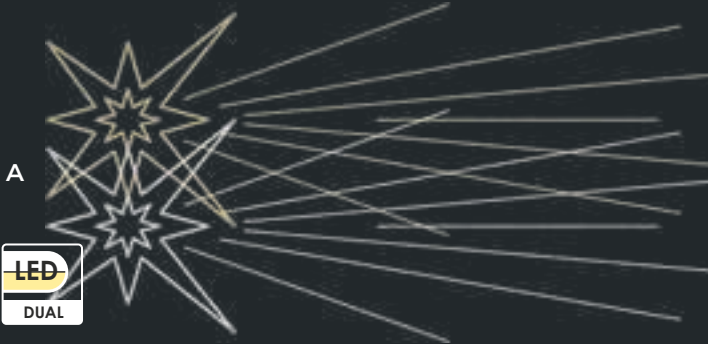

[GRÁFICOS: Unidades en mm/ GRAPHICS: Units in mm/ GRAPHIQUES: Unités en mm/ GRÁFICOS: Unidades em mm]

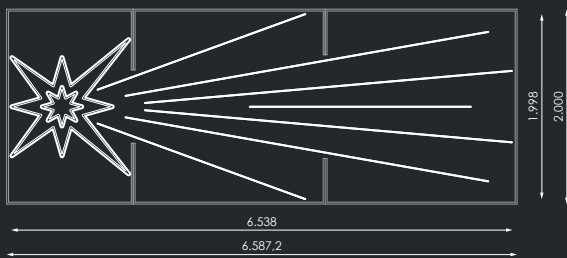

|        |   |                         | W    |
|--------|---|-------------------------|------|
| 209205 | A | flexi LED               | 305W |
| 240437 | B | flexi LED / CLUSTER LED | 78W  |
| 209243 | C | flexi LED               | 218W |
| 209236 | D | flexi LED               | 218W |
| 488723 | E | flexi LED               | 368W |



Cambio entre colores según función seleccionada.  
Switching between colors according to selected function.  
La commutation entre les couleurs en fonction de la fonction sélectionnée.  
Alternando entre as cores de acordo com a função selecionada.

|      |     |                   |      |                                  |      |      |
|------|-----|-------------------|------|----------------------------------|------|------|
|      |     |                   |      |                                  |      |      |
| 230V | CII | IP65<br>IP44 Plug | 28kg | 1- 275x205x6cm<br>2- 162x205x6cm | INC. | 25mm |







[GRÁFICOS: Unidades en mm/ GRÁFICOS: Units in mm/ GRAPHIQUES: Unités en mm/ GRÁFICOS: Unidades em mm]

Santillana del Mar  
Cantabria

# Portada Feria Lágrima



MADE IN SPAIN  
Desing by PRILUX

Motivo  
Motifs  
Motifs  
Motivos

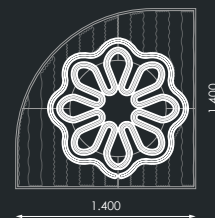
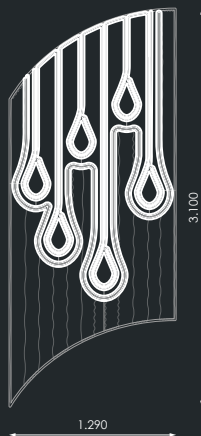
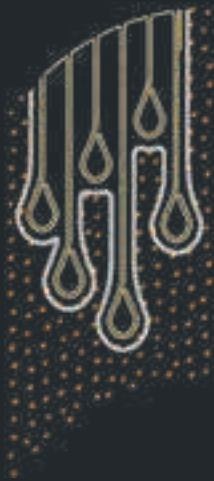

|        |      |           |                   |                 |      |         |
|--------|------|-----------|-------------------|-----------------|------|---------|
| 600187 |      | flexi LED |                   | STRING PLUS LED |      |         |
| W      | ⚡    | □         | ⊙                 | ⚖               | ⌚    | 📏       |
| 924W   | 230V | CII       | IP65<br>IP44 Plug | 117kg           | INC. | 30x30mm |

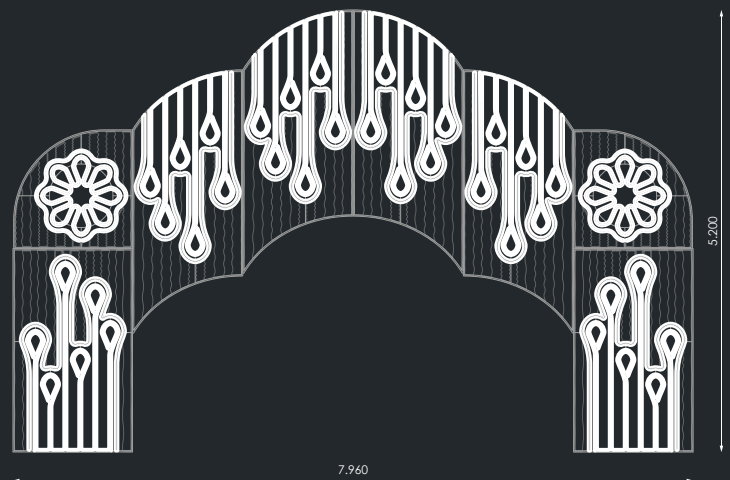

Bajo pedido / On request / Sur commande / A pedido

Ñ/ Posibilidad de diseños diferentes bajo proyecto.

E/ Possibility of different designs under project.

F/ Possibilité de différents designs en cours de projet.

P/ Possibilidade de diferentes desenhos sob projeto.





# Olas y Estrellas

## Pattern



MADE IN SPAIN  
Desing by PRILUX

Motivo  
Motifs  
Motifs  
Motivos



LATERAL  
IZQUIERDA



CENTRAL



LATERAL  
DERECHA

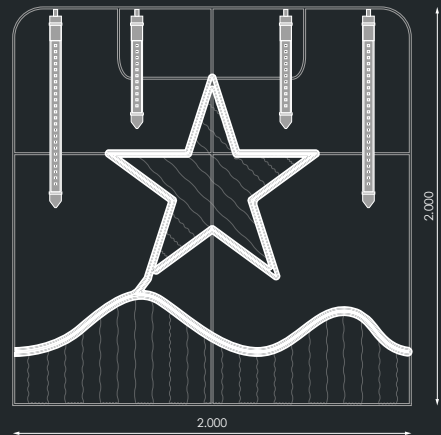

| CENTRAL |          |                 |                   |      |             |      |         |
|---------|----------|-----------------|-------------------|------|-------------|------|---------|
|         |          |                 |                   |      |             |      |         |
| 597593  | flexiLED | STRING PLUS LED | Fall Lite Smart   |      |             |      |         |
| W       |          |                 |                   |      |             |      |         |
| 52W     | 230V     | CII             | IP65<br>IP44 Plug | 10kg | 210x210x7cm | INC. | 10x10mm |

| LATERAL |        |          |                   |                 |             |      |         |
|---------|--------|----------|-------------------|-----------------|-------------|------|---------|
|         |        |          |                   |                 |             |      |         |
| 597685  | 597661 | flexiLED | STRING PLUS LED   | Fall Lite Smart |             |      |         |
| W       |        |          |                   |                 |             |      |         |
| 43W     | 230V   | CII      | IP65<br>IP44 Plug | 7kg             | 210x135x7cm | INC. | 10x10mm |

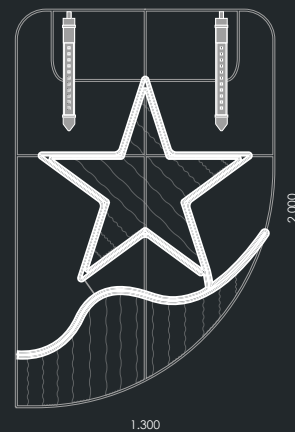



2,6m

Olas y Estrellas Pattern LATERAL

+

Olas y Estrellas Pattern LATERAL

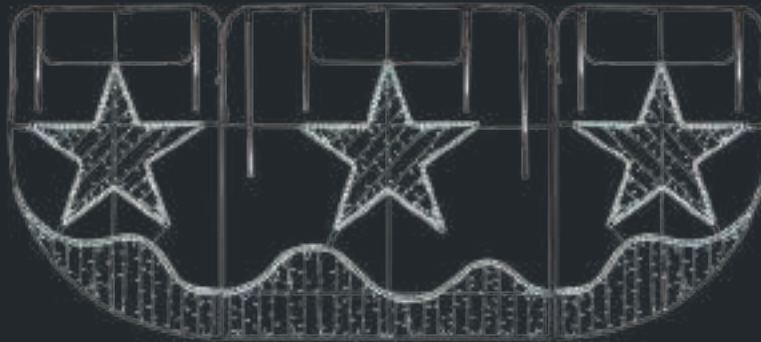

4,6m

Olas y Estrellas Pattern LATERAL

+

Olas y Estrellas Pattern CENTRAL

+

Olas y Estrellas Pattern LATERAL

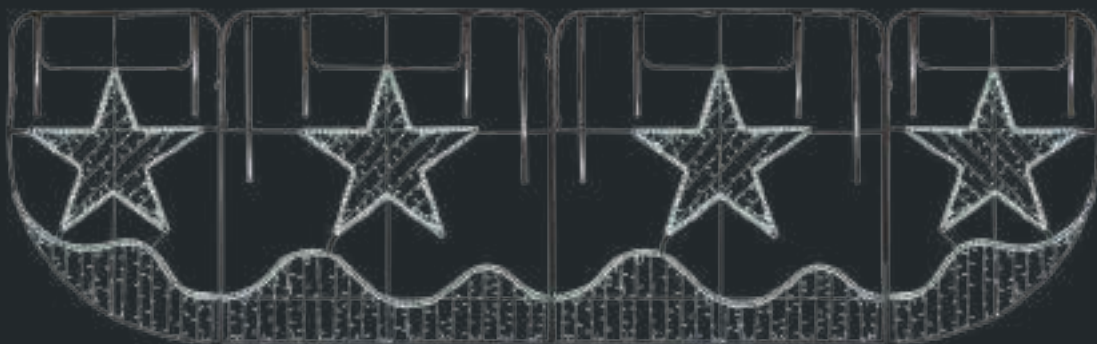

6,6m

Olas y Estrellas Pattern LATERAL

+

Olas y Estrellas Pattern CENTRAL

+

Olas y Estrellas Pattern CENTRAL

+

Olas y Estrellas Pattern LATERAL

Opción de composición/ Composition option  
 Option de composition/ Opção de composição



# Shooting Star Pattern



MADE IN SPAIN  
Desing by PRILUX

Motivo  
Motifs  
Motifs  
Motivos



LATERAL  
IZQUIERDO



CENTRAL  
IZQUIERDO



CENTRAL  
DERECHO

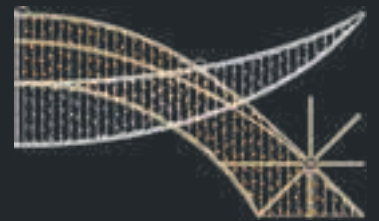

LATERAL  
DERECHO



CENTRAL

|        |        |               |                     |       |               |      |         |
|--------|--------|---------------|---------------------|-------|---------------|------|---------|
|        |        |               |                     |       |               |      |         |
| 529983 | 560191 | flexi LED LED | STRING PLUS LED LED |       |               |      |         |
| W      |        |               |                     |       |               |      |         |
| 70,67W | 230V   | CII           | IP65<br>IP44 Plug   | 8,5kg | 203x183x7,5cm | INC. | 10x10mm |

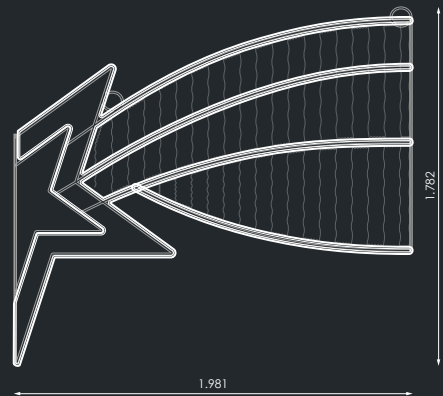

LATERAL

|         |        |               |                     |      |               |      |         |
|---------|--------|---------------|---------------------|------|---------------|------|---------|
|         |        |               |                     |      |               |      |         |
| 529952  | 529969 | flexi LED LED | STRING PLUS LED LED |      |               |      |         |
| W       |        |               |                     |      |               |      |         |
| 141,33W | 230V   | CII           | IP65<br>IP44 Plug   | 14kg | 310x189x7,5cm | INC. | 10x10mm |

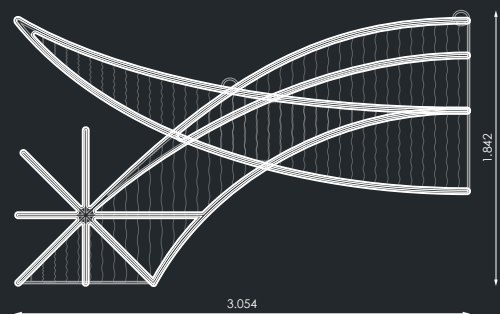





10m

Shooting Star Pattern LATERAL  
izquierda (529952)

+

Shooting Star Pattern CENTRAL  
izquierda (529983)

+

Shooting Star Pattern CENTRAL  
derecha (560191)

+

Shooting Star Pattern LATERAL  
derecha (529969)

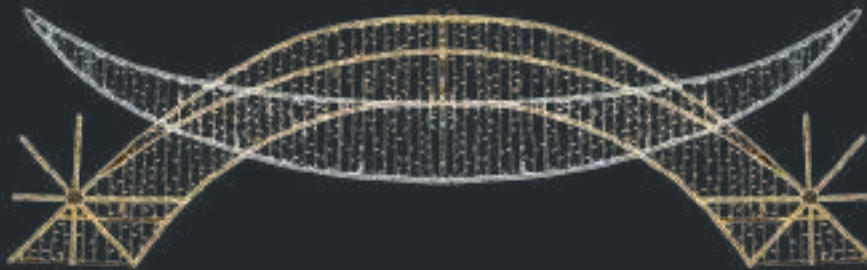

6m

Shooting Star Pattern LATERAL  
izquierda (529952)

+

Shooting Star Pattern LATERAL  
derecha (529969)



4m

Shooting Star Pattern CENTRAL  
izquierda (529983)

+

Shooting Star Pattern CENTRAL  
derecha (560191)

Opción de composición/ Composition option  
Option de composition/ Opção de composição

# Ice Waves

## Pattern



MADE IN SPAIN  
Desing by PRILUX

Motivo  
Motifs  
Motifs  
Motivos



CENTRAL



LATERAL



CENTRAL

560306 flexi LED LED STRING PLUS LED LED

W ⚡ □ ○ ○ /kg ⊞ ⚗ □

91W 230V CII IP65 IP44 Plug 6,5kg 147x173x7,5cm INC. 20x10mm



LATERAL

560290 flexi LED LED STRING PLUS LED LED

W ⚡ □ ○ ○ /kg ⊞ ⚗ □

87W 230V CII IP65 IP44 Plug 10,5kg 205x173x7,5cm INC. 20x10mm





5,4m

Ice Waves Pattern LATERAL

+

Ice Waves Pattern CENTRAL

+

Ice Waves Pattern LATERAL



8m

Ice Waves Pattern LATERAL

+

Ice Waves Pattern LATERAL

+

Ice Waves Pattern LATERAL

+

Ice Waves Pattern LATERAL



4,25m

Ice Waves Pattern CENTRAL

+

Ice Waves Pattern CENTRAL

+

Ice Waves Pattern CENTRAL

Opción de composición/ Composition option  
Option de composition/ Opção de composição



# Wall PIXELMAX P100

240x256cm



MADE IN SPAIN  
Desing by PRILUX

Motivo  
Motifs  
Motifs  
Motivos



N

NEW



Ayto. Cijón  
Asturias



|        |                 |         |                   |      |              |      |         |
|--------|-----------------|---------|-------------------|------|--------------|------|---------|
|        |                 |         |                   |      |              |      |         |
| 609623 | STRING PIXELMAX | 600leds |                   |      |              |      |         |
|        |                 |         |                   |      |              |      |         |
| 240W   | 12V ac          | CII     | IP68<br>IP44 Plug | 25kg | 245x261x15cm | INC. | 25x25mm |

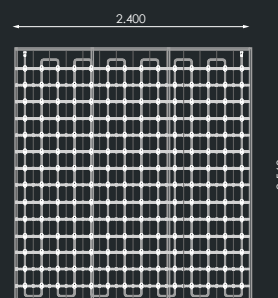

## Información/Information/Information/Informações

Ñ/ Producto servido sin control.

E/ Product served without control.

F/ Produit servi sans contrôle.

P/ Produto servido sem controlo.





MADE IN SPAIN  
Desing by PRILUX

# String Mesh **PIXELMAX** P50

223x168cm

**N**  
NEW

**Motivo**  
Motifs  
Motifs  
Motivos

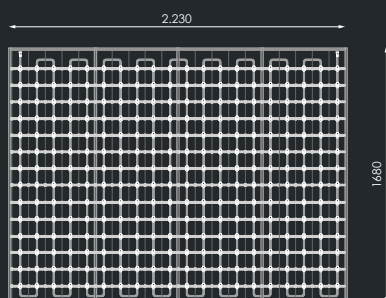

|          |                             |           |                   |      |              |      |         |
|----------|-----------------------------|-----------|-------------------|------|--------------|------|---------|
|          |                             |           |                   |      |              |      |         |
| 634458   | STRING MESH <b>PIXELMAX</b> | 1.260leds |                   |      |              |      |         |
| <b>W</b> |                             |           |                   |      |              |      |         |
| 189W     | 12V ac                      | CII       | IP68<br>IP44 Plug | 30kg | 228x173x15cm | INC. | 25x25mm |

## Información/Information/Information/Informações

**N/** Producto servido sin control.

**E/** Product served without control.

**F/** Produit servi sans contrôle.

**P/** Produto servido sem controlo.



MADE IN SPAIN  
Desing by PRILUX

# String Mesh **PIXELMAX** P50

170x210cm

**N**  
NEW

**Motivo**  
Motifs  
Motifs  
Motivos

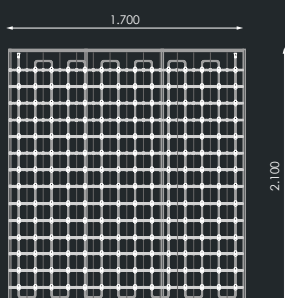

|          |                             |           |                   |      |              |      |         |
|----------|-----------------------------|-----------|-------------------|------|--------------|------|---------|
|          |                             |           |                   |      |              |      |         |
| 634465   | STRING MESH <b>PIXELMAX</b> | 1.280leds |                   |      |              |      |         |
| <b>W</b> |                             |           |                   |      |              |      |         |
| 192W     | 12V ac                      | CII       | IP68<br>IP44 Plug | 31kg | 165x205x15cm | INC. | 25x25mm |

## Información/Information/Information/Informações

**N/** Producto servido sin control.

**E/** Product served without control.

**F/** Produit servi sans contrôle.

**P/** Produto servido sem controlo.

[GRÁFICOS: Unidades en mm/ GRAPHICS: Units in mm/ GRAPHIQUES: Unités en mm/ GRÁFICOS: Unidades em mm]

# Screen PIXELMAX

400x200cm



MADE IN SPAIN  
Desing by PRILUX

Motivo  
Motifs  
Motifs  
Motivos

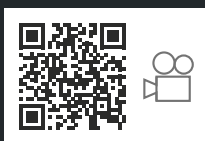

|        |        |                     |      |      |              |      |         |
|--------|--------|---------------------|------|------|--------------|------|---------|
| 562126 |        | SCREEN PIXELMAX LED |      |      |              |      |         |
| W      | ⚡      | □                   | ⊙    | ⚖    | 📦            | 🍷    | 📏       |
| 528W   | 66V ac | CII                 | IP44 | 65kg | 205x205x15cm | INC. | 20x20mm |

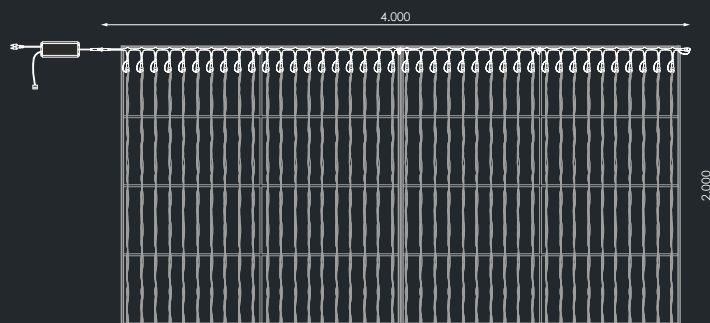

## Información/Information/Information/Informações

**Ñ/** Controlador Master y Slave servidos en caja estanca IP66.

**E/** Master and Slave controller served in IP66 watertight box.

**F/** Contrôleur maître et esclave servi dans une boîte étanche IP66.

**P/** Controladores Master e Slave servidos em caixa estanque IP66.



MADE IN SPAIN  
Desing by PRILUX

# Daisy Flower



Motivo  
Motifs  
Motifs  
Motivos

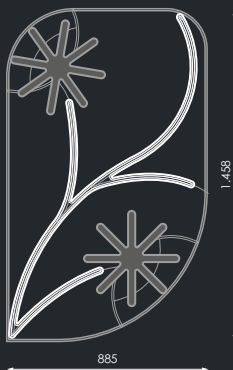
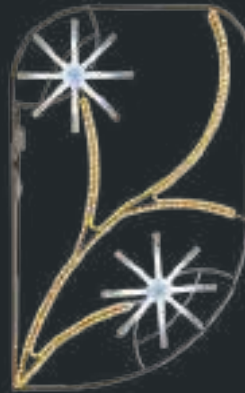

|          |                 |       |                    |     |            |      |         |
|----------|-----------------|-------|--------------------|-----|------------|------|---------|
|          |                 |       |                    |     |            |      |         |
| 597777   | <b>flexiLED</b> | ALPHA |                    |     |            |      |         |
| <b>W</b> |                 |       |                    |     |            |      |         |
| 26W      | 230V            | CII   | IP65<br>IP44, Plug | 5kg | 150x93x7cm | INC. | 20x10mm |



MADE IN SPAIN  
Desing by PRILUX

# Abies



Motivo  
Motifs  
Motifs  
Motivos

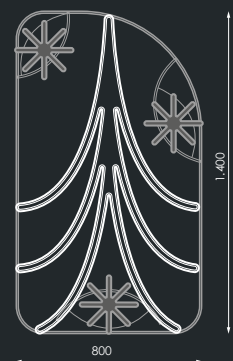

|          |                 |       |                    |     |            |      |         |
|----------|-----------------|-------|--------------------|-----|------------|------|---------|
|          |                 |       |                    |     |            |      |         |
| 600200   | <b>flexiLED</b> | ALPHA |                    |     |            |      |         |
| <b>W</b> |                 |       |                    |     |            |      |         |
| 34,5W    | 230V            | CII   | IP65<br>IP44, Plug | 6kg | 150x93x7cm | INC. | 20x10mm |

[GRÁFICOS: Unidades en mm/ GRAPHICS: Units in mm/ GRAPHIQUES: Unités en mm/ GRÁFICOS: Unidades em mm]

# Three Star



MADE IN SPAIN  
Desing by PRILUX

Motivo  
Motifs  
Motifs  
Motivos



Three Stars

+

Three Stars

Opción de composición/ Composition option  
Option de composition/ Opção de composição



|        |      |                             |                   |     |            |      |         |
|--------|------|-----------------------------|-------------------|-----|------------|------|---------|
|        |      |                             |                   |     |            |      |         |
| 600217 |      | flexi <b>LED</b> <b>LED</b> |                   |     |            |      |         |
| W      |      |                             |                   |     |            |      |         |
| 64,5W  | 230V | CII                         | IP65<br>IP44 Plug | 7kg | 150x93x7cm | INC. | 20x10mm |

# Bolas



MADE IN SPAIN  
Desing by PRILUX

Motivo  
Motifs  
Motifs  
Motivos



Bolas

+

Bolas

Opción de composición/ Composition option  
Option de composition/ Opção de composição

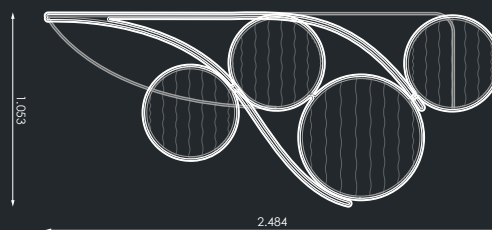

|        |      |                             |                   |                               |             |      |         |
|--------|------|-----------------------------|-------------------|-------------------------------|-------------|------|---------|
|        |      |                             |                   |                               |             |      |         |
| 600224 |      | flexi <b>LED</b> <b>LED</b> |                   | STRING <b>PLUS</b> <b>LED</b> |             |      |         |
| W      |      |                             |                   |                               |             |      |         |
| 60W    | 230V | CII                         | IP65<br>IP44 Plug | 9kg                           | 253x110x7cm | INC. | 20x10mm |





MADE IN SPAIN  
Desing by PRILUX

# Silhouette Star



Motivo  
Motifs  
Motifs  
Motivos

Silhouette Star + Fly + Silhouette Star

Opción de composición/ Composition option  
Option de composition/ Opção de composição

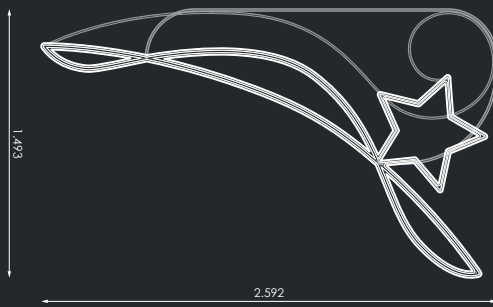

|        |           |           |                     |     |             |      |         |
|--------|-----------|-----------|---------------------|-----|-------------|------|---------|
|        |           |           |                     |     |             |      |         |
| 529020 | flexi LED | flexi LED | STRING PLUS LED LED |     |             |      |         |
| W      |           |           |                     |     |             |      |         |
| 51W    | 230V      | CII       | IP65<br>IP44 Plug   | 6kg | 154x264x5cm | INC. | 20x10mm |



MADE IN SPAIN  
Desing by PRILUX

# Star Duo



Motivo  
Motifs  
Motifs  
Motivos

Star Duo + Star Duo

Opción de composición/ Composition option  
Option de composition/ Opção de composição

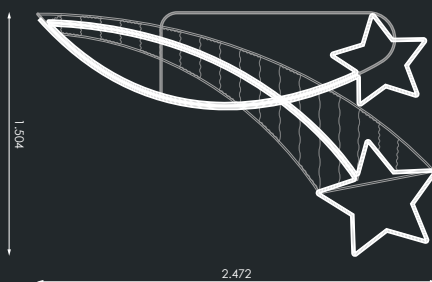

|        |               |                     |                   |     |             |      |         |
|--------|---------------|---------------------|-------------------|-----|-------------|------|---------|
|        |               |                     |                   |     |             |      |         |
| 529099 | flexi LED LED | STRING PLUS LED LED |                   |     |             |      |         |
| W      |               |                     |                   |     |             |      |         |
| 45,6W  | 230V          | CII                 | IP65<br>IP44 Plug | 6kg | 155x252x5cm | INC. | 20x10mm |

[GRÁFICOS: Unidades en mm/ GRAPHICS: Units in mm/ GRÁFICOS: Unidades en mm/ GRAPHICS: Units in mm/ GRÁFICOS: Unidades en mm]

# Eclectic Ulva



MADE IN SPAIN  
Desing by PRILUX

Motivo  
Motifs  
Motifs  
Motivos



A B C



Eclectic Ulva + Tulip + Eclectic Ulva

Opción de composición/ Composition option  
Option de composition/ Opção de composição

|        |   |          |                 | W   |
|--------|---|----------|-----------------|-----|
| 509961 | A | flexiLED | STRING PLUS LED | 41W |
| 509978 | B | flexiLED | STRING PLUS LED | 35W |
| 509985 | C | flexiLED | STRING PLUS LED | 35W |

|      |     |                   |       |             |      |      |
|------|-----|-------------------|-------|-------------|------|------|
| ⚡    | □   | ⊙                 | ⊙/kg  | 📦           | 🔌    | 📏    |
| 230V | CII | IP65<br>IP44 Plug | 6,5kg | 191x108x5cm | INC. | 10mm |

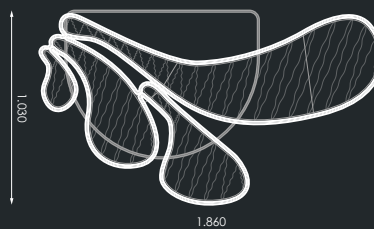

# Eclectic Fan



MADE IN SPAIN  
Desing by PRILUX

Motivo  
Motifs  
Motifs  
Motivos



A B C



Eclectic Fan + Kabalah + Eclectic Fan

Opción de composición/ Composition option  
Option de composition/ Opção de composição

|        |   |          | 1               | 2               | W   |
|--------|---|----------|-----------------|-----------------|-----|
| 510066 | A | flexiLED | STRING PLUS LED | -               | 90W |
| 510073 | B | flexiLED | STRING PLUS LED | STRING PLUS LED | 80W |
| 510080 | C | flexiLED | STRING PLUS LED | STRING PLUS LED | 80W |

|      |     |                   |      |             |      |      |
|------|-----|-------------------|------|-------------|------|------|
| ⚡    | □   | ⊙                 | ⊙/kg | 📦           | 🔌    | 📏    |
| 230V | CII | IP65<br>IP44 Plug | 9kg  | 188x115x5cm | INC. | 10mm |



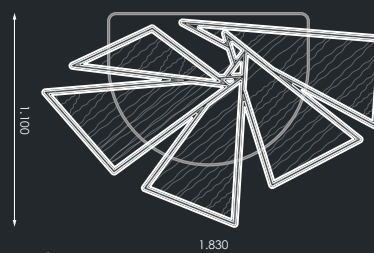

MADE IN SPAIN  
Desing by PRILUX

# Eclectic Nari



Ávila



Motivo  
Motifs  
Motifs  
Motivos



Eclectic  
Nari

+

Tear

+

Eclectic  
Nari



A



B



C



Opción de composición/ Composition option  
Option de composition/ Opção de composição

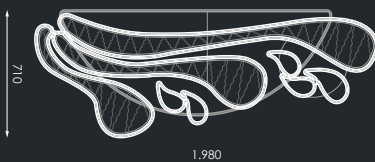

|        |     | □                 | ■                   | W          |      |      |
|--------|-----|-------------------|---------------------|------------|------|------|
| 509916 | A   | flexi LED LED     | STRING PLUS LED     | 50W        |      |      |
| 509923 | B   | flexi LED LED     | STRING PLUS LED LED | 43W        |      |      |
| 509930 | C   | flexi LED LED     | STRING PLUS LED LED | 43W        |      |      |
| ⚡      | □   | ⊙                 | ⚖                   | 📦          | 🔌    | 📏    |
| 230V   | CII | IP65<br>IP44 Plug | 7kg                 | 203x76x5cm | INC. | 10mm |

[GRÁFICOS: Unidades en mm/ GRAPHICS: Units in mm/ GRÁFICOS: Unidades en mm/ GRAPHICS: Units in mm/ GRÁFICOS: Unidades en mm/ GRAPHICS: Units in mm/ GRÁFICOS: Unidades en mm]

# Eclectic Slope



MADE IN SPAIN  
Desing by PRILUX

Motivo  
Motifs  
Motifs  
Motivos



A B C



Fly + Eclectic Slope + Fly

Opción de composición/ Composition option  
Option de composition/ Opção de composição

|        |   |          |                 | W   |
|--------|---|----------|-----------------|-----|
| 510011 | A | flexiLED | STRING PLUS LED | 60W |
| 510028 | B | flexiLED | STRING PLUS LED | 55W |
| 510035 | C | flexiLED | STRING PLUS LED | 55W |

|      |     |                   |      |            |      |      |
|------|-----|-------------------|------|------------|------|------|
| ⚡    | □   | ⊙                 | ⊙/kg | 📦          | 🔌    | 📏    |
| 230V | CII | IP65<br>IP44 Plug | 6kg  | 194x80x5cm | INC. | 10mm |

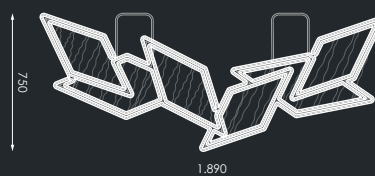

# Eclectic Hive



MADE IN SPAIN  
Desing by PRILUX

Motivo  
Motifs  
Motifs  
Motivos

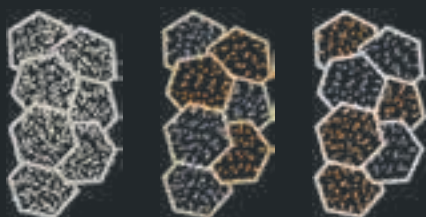

A B C

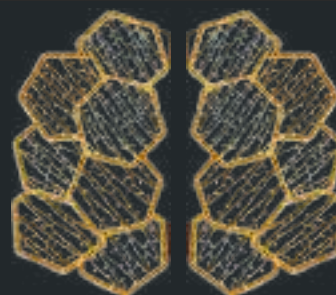

Eclectic Hive + Eclectic Hive

Opción de composición/ Composition option  
Option de composition/ Opção de composição

|        |   |          | 1               | 2               | W   |
|--------|---|----------|-----------------|-----------------|-----|
| 510110 | A | flexiLED | STRING PLUS LED | -               | 83W |
| 510127 | B | flexiLED | STRING PLUS LED | STRING PLUS LED | 74W |
| 510134 | C | flexiLED | STRING PLUS LED | STRING PLUS LED | 74W |

|      |     |                   |      |             |      |      |
|------|-----|-------------------|------|-------------|------|------|
| ⚡    | □   | ⊙                 | ⊙/kg | 📦           | 🔌    | 📏    |
| 230V | CII | IP65<br>IP44 Plug | 8kg  | 188x102x5cm | INC. | 10mm |



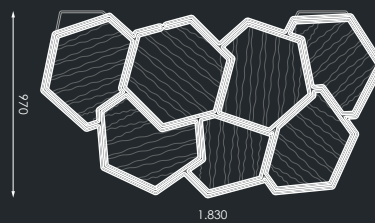



MADE IN SPAIN  
Desing by PRILUX

# Infinity



Ávila



**Motivo**  
 Motifs  
 Motifs  
 Motivos



Nadir

+

Nadir

Opción de composición/ Composition option  
 Option de composition/ Opção de composição



| 416092 | A | flexi | LED LED |
|--------|---|-------|---------|
| 416108 | B | flexi | LED LED |
| 416115 | C | flexi | LED LED |
| 416122 | D | flexi | LED LED |
| 416139 | E | flexi | LED LED |

|     |   |  |   |   |   |   |   |
|-----|---|--|---|---|---|---|---|
| W   |  |  |  |  |  |  |  |
| 45W | 230V  | CII  | IP65<br>IP44 Plug   | 6kg   | 260x78x5cm  | INC.  | 10mm  |

[GRÁFICOS: Unidades en mm/ GRAPHICS: Units in mm/ GRÁFICOS: Unidades en mm/ GRAPHICS: Units in mm/ GRÁFICOS: Unidades en mm/ GRAPHICS: Units in mm]

# Nadir



MADE IN SPAIN  
Desing by PRILUX

Motivo  
Motifs  
Motifs  
Motivos



Nadir + Nadir

Opción de composición/ Composition option  
Option de composition/ Opção de composição

| 385954 | A    | flexi LED | STRING PLUS       | 11kg | 128x263x5cm | INC. | 20x10mm |
|--------|------|-----------|-------------------|------|-------------|------|---------|
| 385961 | B    | flexi LED | STRING PLUS       | 11kg | 128x263x5cm | INC. | 20x10mm |
| 64W    | 230V | CII       | IP65<br>IP44 Plug | 11kg | 128x263x5cm | INC. | 20x10mm |

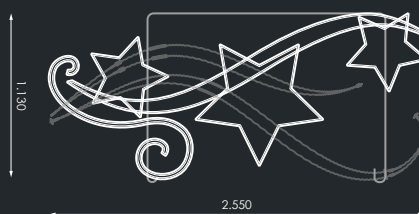

# Wimbi String



MADE IN SPAIN  
Desing by PRILUX

Motivo  
Motifs  
Motifs  
Motivos

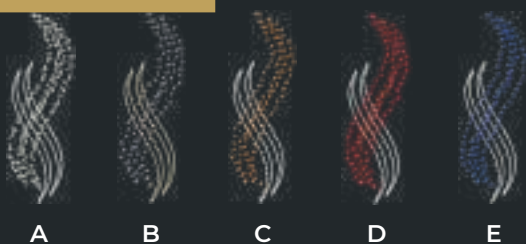

Wimbi String + Arkaid + Wimbi String

Opción de composición/ Composition option  
Option de composition/ Opção de composição

| 488747 | A    | flexi LED | STRING PLUS       | 4kg | 73x205x5cm | INC. | 10mm |
|--------|------|-----------|-------------------|-----|------------|------|------|
| 415453 | B    | flexi LED | STRING PLUS       | 4kg | 73x205x5cm | INC. | 10mm |
| 415460 | C    | flexi LED | STRING PLUS       | 4kg | 73x205x5cm | INC. | 10mm |
| 415477 | D    | flexi LED | STRING PLUS       | 4kg | 73x205x5cm | INC. | 10mm |
| 415484 | E    | flexi LED | STRING PLUS       | 4kg | 73x205x5cm | INC. | 10mm |
| 23W    | 230V | CII       | IP65<br>IP44 Plug | 4kg | 73x205x5cm | INC. | 10mm |

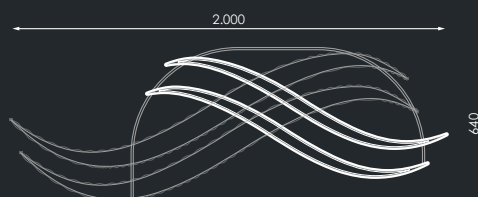



MADE IN SPAIN  
Desing by PRILUX

# Wimbi



Motivo  
Motifs  
Motifs  
Motivos



Ávila



Wimbi

+

Wimbi

Opción de composición/ Composition option  
Option de composition/ Opção de composição

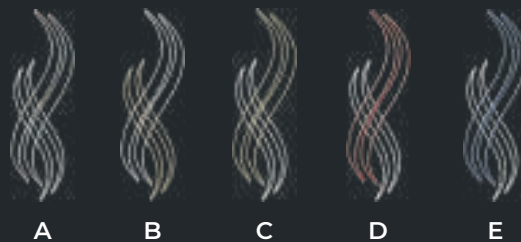
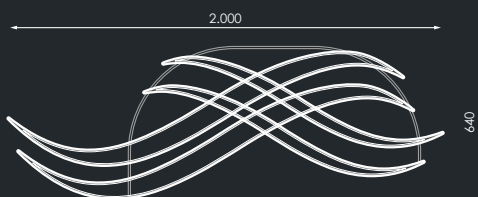

| 488730 | A | flexi | LED LED |
|--------|---|-------|---------|
| 412902 | B | flexi | LED LED |
| 415408 | C | flexi | LED LED |
| 415415 | D | flexi | LED LED |
| 415422 | E | flexi | LED LED |

W



40W

230V

CII

IP65  
IP44 Plug

4kg

73x205x5cm

INC.

10mm

[GRÁFICOS: Unidades en mm/ GRAPHICS: Units in mm/ GRAPHIQUES: Unités en mm/ GRÁFICOS: Unidades em mm]

# Angelo's Neon



MADE IN SPAIN  
Desing by PRILUX

Motivo  
Motifs  
Motifs  
Motivos



A



B



C



D



| Barcode | Model | Name     | Light Source             |
|---------|-------|----------|--------------------------|
| 529662  | A     | ARPA     | flexiDOUBLE NEON LED LED |
| 529679  | B     | TROMPETA | flexiDOUBLE NEON LED LED |
| 529686  | C     | CANDELA  | flexiDOUBLE NEON LED LED |
| 529693  | D     | CAMPANA  | flexiDOUBLE NEON LED LED |

|     |      |     |                   |     |             |      |      |
|-----|------|-----|-------------------|-----|-------------|------|------|
| W   | ⚡    | ⊞   | ⦿                 | ⚖   | 📦           | ⏏    | 📏    |
| 99W | 230V | CII | IP65<br>IP44 Plug | 5kg | 140x192x5cm | INC. | 10mm |



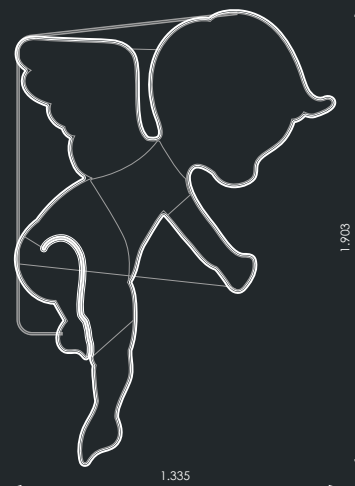



MADE IN SPAIN  
Desing by PRILUX

# Angel Vela



Motivo  
Motifs  
Motifs  
Motivos



A



B

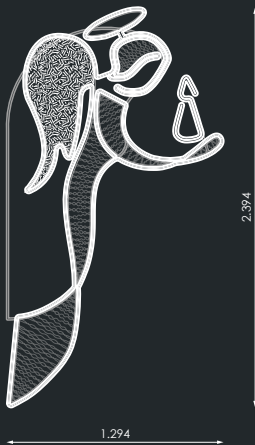

|        |      |               |                     |       |             |      |         |
|--------|------|---------------|---------------------|-------|-------------|------|---------|
|        |      |               |                     |       |             |      |         |
| 210003 | A    | flexi LED LED | STRING PLUS LED LED | TAPIZ |             |      |         |
| 387408 | B    | flexi LED LED | STRING PLUS LED LED | TAPIZ |             |      |         |
| W      | ⚡    | □             | ⊙                   | ⚖     | 📦           | 🔌    | 📏       |
| 62,5W  | 230V | CII           | IP65<br>IP44, Plug  | 7,5kg | 150x263x5cm | INC. | 20x10mm |



MADE IN SPAIN  
Desing by PRILUX

# Céfiro



Motivo  
Motifs  
Motifs  
Motivos



Céfiro

+

Star Mini

+

Céfiro

Opción de composición/ Composition option  
Option de composition/ Opção de composição



A



B

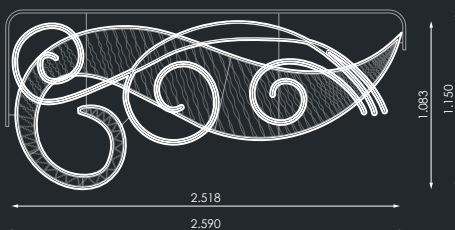

|        |      |               |                    |      |             |      |         |
|--------|------|---------------|--------------------|------|-------------|------|---------|
|        |      |               |                    |      |             |      |         |
| 386159 | A    | flexi LED LED | STRING PLUS LED    |      |             |      |         |
| 385893 | B    | flexi LED LED | STRING PLUS LED    |      |             |      |         |
| W      | ⚡    | □             | ⊙                  | ⚖    | 📦           | 🔌    | 📏       |
| 102W   | 230V | CII           | IP65<br>IP44, Plug | 11kg | 116x268x5cm | INC. | 20x10mm |

[GRÁFICOS: Unidades en mm/ GRAPHICS: Units in mm/ GRÁFICOS: Unidades en mm/ GRAPHICS: Units in mm/ GRÁFICOS: Unidades en mm]

# Acanto



MADE IN SPAIN  
Desing by PRILUX

Motivo  
Motifs  
Motifs  
Motivos



A B C



Acanto + Star mini + Acanto

Opción de composición/ Composition option  
Option de composition/ Opção de composição

| 385992 | A    | flexi LED LED | STRING PLUS LED   |     |             |      |      |
|--------|------|---------------|-------------------|-----|-------------|------|------|
| 386005 | B    | flexi LED LED | STRING PLUS LED   |     |             |      |      |
| 386012 | C    | flexi LED LED | STRING PLUS LED   |     |             |      |      |
| W      | ⚡    | □             | ⊙                 | ⊙   | ⊙           | ⊙    | ⊙    |
| 55W    | 230V | CII           | IP65<br>IP44 Plug | 9kg | 118x268x5cm | INC. | 10mm |

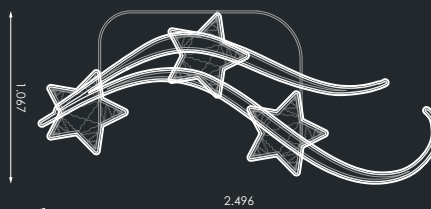

# Spiral Loop



MADE IN SPAIN  
Desing by PRILUX

Motivo  
Motifs  
Motifs  
Motivos



A B C D



Spiral Loop + Spiral Loop

Opción de composición/ Composition option  
Option de composition/ Opção de composição

| 209267 | A    | flexi LED | STRING PLUS LED     | TAPIZ | 1          |      |      |
|--------|------|-----------|---------------------|-------|------------|------|------|
| 209274 | B    | flexi LED | STRING PLUS LED LED | TAPIZ | 2          |      |      |
| 209281 | C    | flexi LED | STRING PLUS LED LED | TAPIZ |            |      |      |
| 209298 | D    | flexi LED | STRING PLUS LED LED | TAPIZ |            |      |      |
| W      | ⚡    | □         | ⊙                   | ⊙     | ⊙          | ⊙    | ⊙    |
| 36W    | 230V | CII       | IP65<br>IP44 Plug   | 7,5kg | 80x263x5cm | INC. | 25mm |





MADE IN SPAIN  
Desing by PRILUX

# Flower Star



**Motivo**  
 Motifs  
 Motifs  
 Motivos

Ávila

[GRÁFICOS: Unidades en mm/ GRAPHICS: Units in mm/ GRAPHIQUES: Unités en mm/ GRÁFICOS: Unidades em mm]



Flower Star + Star mini Double + Flower Star

OPCIÓN DE COMPOSICIÓN/ COMPOSITION OPTION  
OPTION DE COMPOSITION/ OPÇÃO DE COMPOSIÇÃO



A B



|          |        |      |              |
|----------|--------|------|--------------|
|          |        |      |              |
|          | 209403 | A    | <b>flexi</b> |
|          | 209434 | B    | <b>flexi</b> |
| <b>W</b> |        |      |              |
| 78W      | 230V   | CII  | 11kg         |
|          |        |      |              |
|          |        | IP65 | IP44         |
|          |        |      |              |
|          |        | INC. | 20x10mm      |





Ávila





MADE IN SPAIN  
Desing by PRILUX

# Flambeau



Flambeau + Tears + Flambeau

Opción de composición/ Composition option  
Option de composition/ Opção de composição

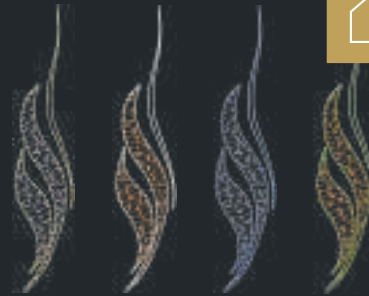
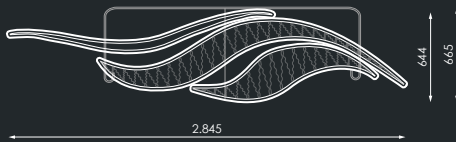

A B C D

Home icon, Flame icon, Motivo/Motifs/Motifs/Motivos icons



| Code   | Option | flexiLED | STRING PLUS LED |
|--------|--------|----------|-----------------|
| 209717 | A      | flexiLED | STRING PLUS LED |
| 209724 | B      | flexiLED | STRING PLUS LED |
| 209731 | C      | flexiLED | STRING PLUS LED |
| 209748 | D      | flexiLED | STRING PLUS LED |

  

|     |      |     |                   |       |            |      |         |
|-----|------|-----|-------------------|-------|------------|------|---------|
| W   | ⚡    | □   | ⦿                 | ⚖     | 📦          | 🔌    | 📏       |
| 42W | 230V | CII | IP65<br>IP44 Plug | 6,5kg | 67x305x5cm | INC. | 20x10mm |



MADE IN SPAIN  
Desing by PRILUX

# Spiral Star

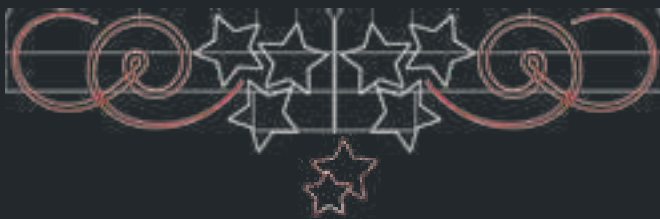

Spiral Star + Double star + Spiral Star

Opción de composición/ Composition option  
Option de composition/ Opção de composição

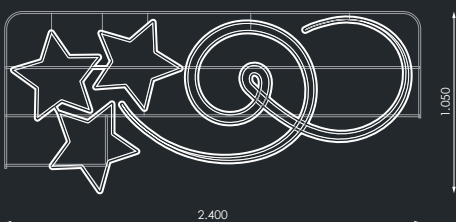

A B C

Home icon, Flame icon, Motivo/Motifs/Motifs/Motivos icons



| Code   | Option | flexiLED | LED |
|--------|--------|----------|-----|
| 209311 | A      | flexiLED | LED |
| 209335 | B      | flexiLED | LED |
| 209328 | C      | flexiLED | LED |

|     |      |     |                   |     |             |      |         |
|-----|------|-----|-------------------|-----|-------------|------|---------|
| W   | ⚡    | □   | ⦿                 | ⚖   | 📦           | 🔌    | 📏       |
| 47W | 230V | CII | IP65<br>IP44 Plug | 7kg | 111x250x5cm | INC. | 20x10mm |

[GRÁFICOS: Unidades en mm/ GRAPHICS: Units in mm/ GRÁFICOS: Unidades em mm/ GRAPHICS: Units in mm]

Motivo  
Motifs  
Motifs  
Motivos



Guadalupe  
Cáceres

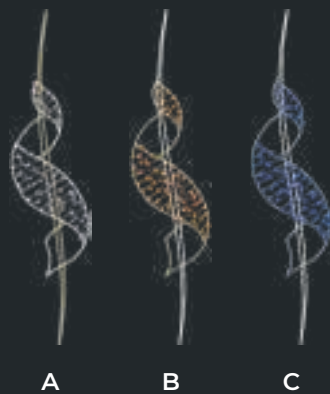

Agard + Arkaid + Agard

Opción de composición/ Composition option  
Option de composition/ Opção de composição



| 209823 | A | flexi | STRING |
|--------|---|-------|--------|
| 209847 | B | flexi | STRING |
| 209878 | C | flexi | STRING |

|     |      |     |                   |     |            |      |      |
|-----|------|-----|-------------------|-----|------------|------|------|
|     |      |     |                   |     |            |      |      |
| 45W | 230V | CII | IP65<br>IP44 Plug | 8kg | 80x312x5cm | INC. | 25mm |



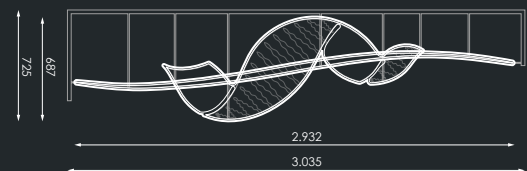

MADE IN SPAIN  
Desing by PRILUX

# Arabesque



Motivo  
Motifs  
Motifs  
Motivos

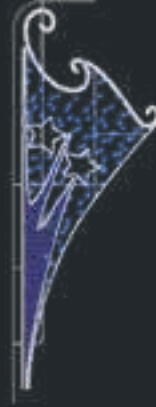

|        |             |                 |                   |
|--------|-------------|-----------------|-------------------|
|        |             |                 |                   |
| 148986 | flexi LED   | STRING PLUS LED | TAPIZ             |
| W      |             |                 |                   |
| 51W    | 230V        | CII             | IP65<br>IP44 Plug |
|        |             |                 |                   |
| 7kg    | 105x273x5cm | INC.            | 20x10mm           |



MADE IN SPAIN  
Desing by PRILUX

# Estrellas



Motivo  
Motifs  
Motifs  
Motivos



Estrellas

+

Estrellas

Opción de composición/ Composition option  
Option de composition/ Opção de composição



A

B

C



|             |      |                   |     |
|-------------|------|-------------------|-----|
|             |      |                   | W   |
| 385244      | A    | flexi LED         | 21W |
| 972062      | B    | flexi LED         | 21W |
| 385251      | C    | flexi LED         | 25W |
|             |      |                   |     |
| 230V        | CII  | IP65<br>IP44 Plug | 8kg |
|             |      |                   |     |
| 121x210x5cm | INC. | 20x10mm           |     |

[GRÁFICOS: Unidades en mm/ GRAPHICS: Units in mm/ GRÁFICOS: Unidades em mm/ GRAPHICS: Units in mm]

# Bolas con Lazo



MADE IN SPAIN  
Desing by PRILUX

Motivo  
Motifs  
Motifs  
Motivos



|        |               | 1               | 2                 |
|--------|---------------|-----------------|-------------------|
| 600231 | flexi LED LED | STRING PLUS LED | STRING PLUS LED   |
| 595360 | flexi LED LED | STRING PLUS LED | STRING PLUS LED   |
| W      | ⚡             | □               | ⦿                 |
| 70W    | 230V          | CII             | IP65<br>IP44 Plug |
|        |               | 8kg             | 128x191x7cm       |
|        |               |                 | INC.              |
|        |               |                 | 10x10mm           |



Accesorios (NO Incluidos) / Accessoires (NOT Included) / Accessories (NON Inclus) / Acessórios (NÃO Incluso)  
+ INFO PAG. página T75



Brazo para motivos Calle/Fachada/Mini





MADE IN SPAIN  
Desing by PRILUX

# Campana con Lazo



Motivo  
Motifs  
Motifs  
Motivos

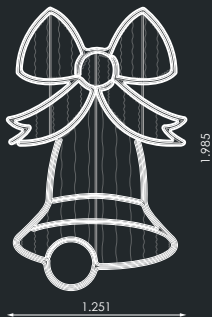

|        |       |        |                   |       |             |      |         |
|--------|-------|--------|-------------------|-------|-------------|------|---------|
|        |       |        |                   |       |             |      |         |
| 595353 | flexi | STRING | STRING            |       |             |      |         |
|        |       |        |                   |       |             |      |         |
| 88W    | 230V  | CL     | IP65<br>IP44 Plug | 8,5kg | 129x211x7cm | INC. | 10x10mm |

Accesorios (NO Incluidos) / Accessoires (NOT Included) / Accessories (NON Inclus) / Acessórios (NÃO Incluso)  
+ INFO PAC, página T75



Brazo para motivos Calle/Fachada/Mini

[GRÁFICOS: Unidades en mm/ GRAPHICS: Units in mm/ GRAPHIQUES: Unités en mm/ GRÁFICOS: Unidades em mm]

# Melchor



MADE IN SPAIN  
Desing by PRILUX

Motivo  
Motifs  
Motifs  
Motivos

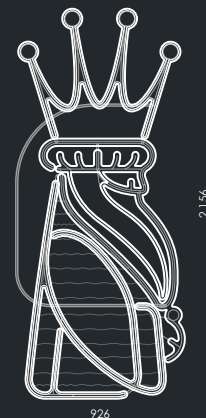

567190

flexi **LED** **LED** **LED**

STRING **PLUS** **LED**



84W

230V

CII

IP65  
IP44 Plug

8kg

110x225x5cm

INC.

10x20mm



MADE IN SPAIN  
Desing by PRILUX

# Gaspar



Motivo  
Motifs  
Motifs  
Motivos



Bollullos de la Migración  
Sevilla



567206

flexi LED LED LED

STRING PLUS LED

W



87W

230V

ClI

IP65  
IP44 Plug

8kg

110x225x5cm

INC.

10x20mm

[GRÁFICOS: Unidades en mm/ GRAPHICS: Units in mm/ GRAPHIQUES: Unités en mm/ GRÁFICOS: Unidades en mm]



Bargas  
Toledo





MADE IN SPAIN  
Desing by PRILUX

# Baltasar



Motivo  
Motifs  
Motifs  
Motivos

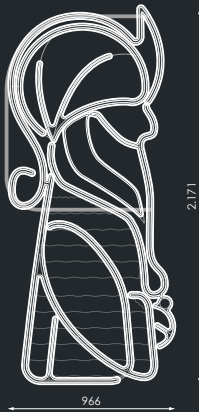

|        |      |                       |                   |       |             |                 |         |  |
|--------|------|-----------------------|-------------------|-------|-------------|-----------------|---------|--|
| 567213 |      | flexi LED LED LED LED |                   |       |             | STRING PLUS LED |         |  |
| W      | ⚡    | □                     | ⊙                 | ⚖     | 📦           | 🔌               | 📏       |  |
| 96W    | 230V | CII                   | IP65<br>IP44 Plug | 8,5kg | 110x225x5cm | INC.            | 10x20mm |  |

[GRÁFICOS: Unidades en mm/ GRAPHICS: Units in mm/ GRAPHIQUES: Unités en mm/ GRÁFICOS: Unidades en mm]



MADE IN SPAIN  
Desing by PRILUX

# Camello



Motivo  
Motifs  
Motifs  
Motivos

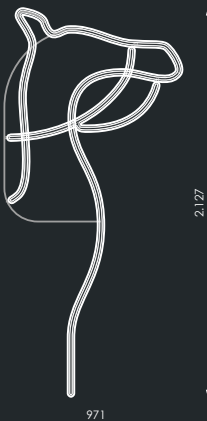

|        |      |               |                   |       |             |      |         |
|--------|------|---------------|-------------------|-------|-------------|------|---------|
| 567220 |      | flexi LED LED |                   |       |             |      |         |
| W      | ⚡    | □             | ⊙                 | ⚖     | 📦           | 🔌    | 📏       |
| 36W    | 230V | CII           | IP65<br>IP44 Plug | 3,5kg | 110x225x5cm | INC. | 10x20mm |

# Bolma

## Lilium



MADE IN SPAIN  
Desing by PRILUX

Motivo  
Motifs  
Motifs  
Motivos



|        |       |             |                   |        |                |      |         |
|--------|-------|-------------|-------------------|--------|----------------|------|---------|
|        |       |             |                   |        |                |      |         |
| 567237 | flexi | STRING PLUS |                   |        |                |      |         |
|        |       |             |                   |        |                |      |         |
| 123W   | 230V  | CII         | IP65<br>IP44 Plug | 13,5kg | 190x1905x7,5cm | INC. | 10x20mm |

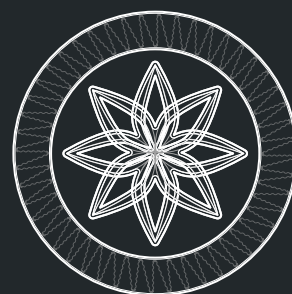

Ø1.1800

# Bolma

## Arkaid



MADE IN SPAIN  
Desing by PRILUX

Motivo  
Motifs  
Motifs  
Motivos



|        |       |             |                   |        |                |      |         |
|--------|-------|-------------|-------------------|--------|----------------|------|---------|
|        |       |             |                   |        |                |      |         |
| 567244 | flexi | STRING PLUS |                   |        |                |      |         |
|        |       |             |                   |        |                |      |         |
| 111W   | 230V  | CII         | IP65<br>IP44 Plug | 11,5kg | 190x1905x7,5cm | INC. | 10x20mm |

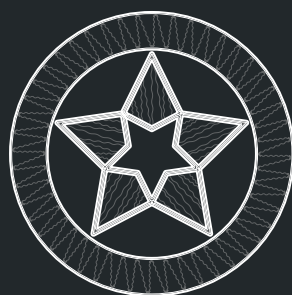

Ø1.1800



MADE IN SPAIN  
Desing by PRILUX

# Bolma

## Star Flake

**Motivo**  
 Motifs  
 Motifs  
 Motivos



|          |                 |                               |                    |        |                |      |         |
|----------|-----------------|-------------------------------|--------------------|--------|----------------|------|---------|
|          |                 |                               |                    |        |                |      |         |
| 567251   | <b>flexiLED</b> | STRING <b>PLUS</b> <b>LED</b> |                    |        |                |      |         |
| <b>W</b> |                 |                               |                    |        |                |      |         |
| 120W     | 230V            | ClI                           | IP65<br>IP44, Plug | 11,4kg | 190x1905x7,5cm | INC. | 10x20mm |

[GRÁFICOS: Unidades en mm/ GRAPHICS: Units in mm/ GRAPHIQUES: Unités en mm/ GRÁFICOS: Unidades en mm]



MADE IN SPAIN  
Desing by PRILUX

# Bulán

**Motivo**  
 Motifs  
 Motifs  
 Motivos

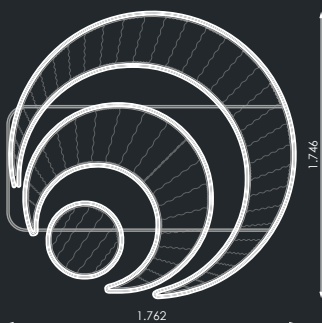

|          |                 |                               |                    |       |               |      |         |
|----------|-----------------|-------------------------------|--------------------|-------|---------------|------|---------|
|          |                 |                               |                    |       |               |      |         |
| 529082   | <b>flexiLED</b> | STRING <b>PLUS</b> <b>LED</b> |                    |       |               |      |         |
| <b>W</b> |                 |                               |                    |       |               |      |         |
| 58,6W    | 230V            | ClI                           | IP65<br>IP44, Plug | 7,3kg | 190x190x7,5cm | INC. | 10x20mm |

# Bulán



MADE IN SPAIN  
Desing by PRILUX

Motivo  
Motifs  
Motifs  
Motivos



A B C

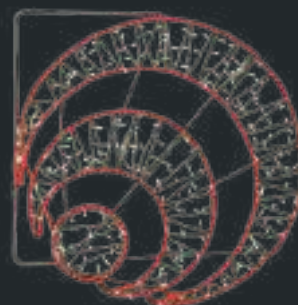

| 414982 | A    | flexi LED | STRING PLUS LED   |     |             |      |      |
|--------|------|-----------|-------------------|-----|-------------|------|------|
| 567343 | B    | flexi LED | STRING PLUS LED   |     |             |      |      |
| 567350 | C    | flexi LED | STRING PLUS LED   |     |             |      |      |
| W      | ⚡    | □         | ⊙                 | ⊙   | ⊙           | ⊙    | ⊙    |
| 36W    | 230V | CII       | IP65<br>IP44 Plug | 6kg | 115x115x5cm | INC. | 10mm |

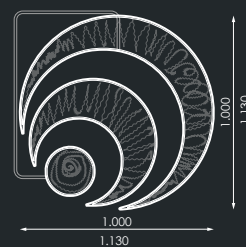

# Stea



MADE IN SPAIN  
Desing by PRILUX

Motivo  
Motifs  
Motifs  
Motivos



A B C



| 441629 | A    | flexi LED | flexi LED         |     |             |      |      |
|--------|------|-----------|-------------------|-----|-------------|------|------|
| 441636 | B    | flexi LED | flexi LED         |     |             |      |      |
| 441643 | C    | flexi LED | flexi LED         |     |             |      |      |
| W      | ⚡    | □         | ⊙                 | ⊙   | ⊙           | ⊙    | ⊙    |
| 78W    | 230V | CII       | IP65<br>IP44 Plug | 8kg | 135x160x5cm | INC. | 10mm |

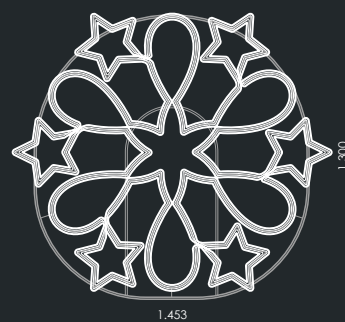





CC. Way Dos Hermanas  
Dos Hermanas, Sevilla

# Cometa II



MADE IN SPAIN  
Desing by PRILUX

Motivo  
Motifs  
Motifs  
Motivos



A



B



C



|        |   |                   | W     |
|--------|---|-------------------|-------|
| 489560 | A | flexi DOUBLE NEON | 63W   |
| 488815 | B | flexi DOUBLE NEON | 63W   |
| 488785 | C | flexi             | 32,2W |

|      |     |                   |     |            |      |         |
|------|-----|-------------------|-----|------------|------|---------|
|      |     |                   |     |            |      |         |
| 230V | CII | IP65<br>IP44 Plug | 2kg | 110x50x5cm | INC. | 10x10mm |

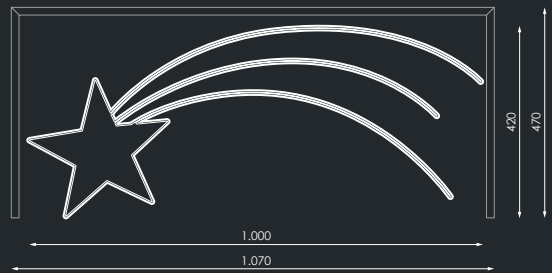

|        |   |                   | W   |
|--------|---|-------------------|-----|
| 489577 | A | flexi DOUBLE NEON | 90W |
| 488822 | B | flexi DOUBLE NEON | 90W |
| 488792 | C | flexi             | 46W |

|      |     |                   |       |            |      |         |
|------|-----|-------------------|-------|------------|------|---------|
|      |     |                   |       |            |      |         |
| 230V | CII | IP65<br>IP44 Plug | 3,5kg | 159x71x5cm | INC. | 10x10mm |

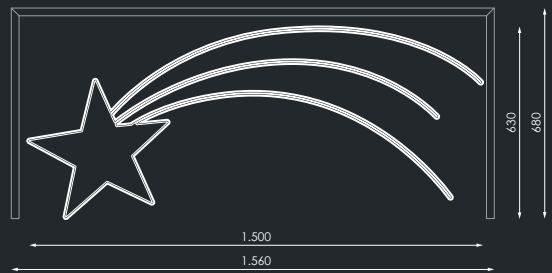

|        |   |                   | W     |
|--------|---|-------------------|-------|
| 489584 | A | flexi DOUBLE NEON | 189W  |
| 488839 | B | flexi DOUBLE NEON | 189W  |
| 488808 | C | flexi             | 96,6W |

|      |     |                   |     |             |      |         |
|------|-----|-------------------|-----|-------------|------|---------|
|      |     |                   |     |             |      |         |
| 230V | CII | IP65<br>IP44 Plug | 9kg | 311x133x5cm | INC. | 20x10mm |

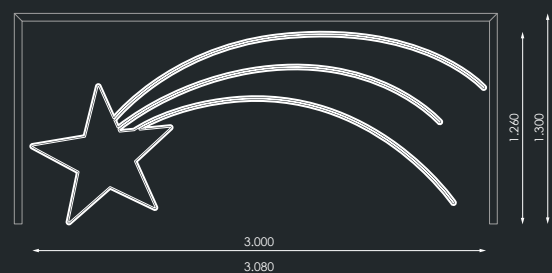





MADE IN SPAIN  
Desing by PRILUX

# Reyes Magos con Estrella Fugaz





**Motivo**  
 Motifs  
 Motifs  
 Motivos

[GRÁFICOS: Unidades en mm/ GRAPHICS: Units in mm/GRAPHIQUES: Unités en mm/GRÁFICOS: Unidades em mm]

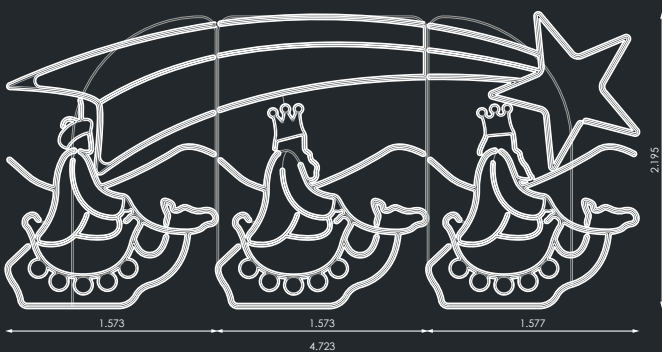

|        |      |               |                   |      |              |      |         |
|--------|------|---------------|-------------------|------|--------------|------|---------|
| 567367 |      | flexi LED LED |                   |      |              |      |         |
| W      | ⚡    | □             | ⊙                 | ⚖    | 📦            | ⏏    | 📏       |
| 306W   | 230V | CII           | IP65<br>IP44 Plug | 28kg | 170x230x20cm | INC. | 10x20mm |







MADE IN SPAIN  
Desing by PRILUX

# Belén

## 2D

**Motivo**  
 Motifs  
 Motifs  
 Motivos



|        |      |       |                   |      |               |      |         |
|--------|------|-------|-------------------|------|---------------|------|---------|
|        |      |       |                   |      |               |      |         |
| 563635 |      | flexi |                   |      |               |      |         |
|        |      |       |                   |      |               |      |         |
| 153W   | 230V | ClI   | IP65<br>IP44 Plug | 15kg | 280x200x7,5cm | INC. | 10x20mm |



MADE IN SPAIN  
Desing by PRILUX

# Belén

## 2D String

**Motivo**  
 Motifs  
 Motifs  
 Motivos



|        |      |       |                   |             |               |      |         |
|--------|------|-------|-------------------|-------------|---------------|------|---------|
|        |      |       |                   |             |               |      |         |
| 564823 |      | flexi |                   | STRING PLUS |               |      |         |
|        |      |       |                   |             |               |      |         |
| 164W   | 230V | ClI   | IP65<br>IP44 Plug | 17kg        | 280x200x7,5cm | INC. | 10x20mm |

[GRÁFICOS: Unidades en mm/ GRAPHICS: Units in mm/ GRAPHIQUES: Unités en mm/ GRÁFICOS: Unidades em mm]

# Lilium

## Punta Cono



MADE IN SPAIN  
Desing by PRILUX

# Lilium



MADE IN SPAIN  
Desing by PRILUX

Motivo  
Motifs  
Motifs  
Motivos



|        |       |     |            |
|--------|-------|-----|------------|
|        |       |     |            |
| 516327 | flexi | LED | Ø78cm 6-8m |

|     |      |     |                   |       |           |      |
|-----|------|-----|-------------------|-------|-----------|------|
| W   |      |     |                   |       |           |      |
| 36W | 230V | CII | IP65<br>IP44 Plug | 4,3kg | 83x83x5cm | INC. |

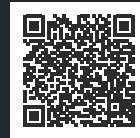

|        |       |     |       |
|--------|-------|-----|-------|
|        |       |     |       |
| 510141 | flexi | LED | Ø78cm |

|     |      |     |                   |     |           |      |
|-----|------|-----|-------------------|-----|-----------|------|
| W   |      |     |                   |     |           |      |
| 36W | 230V | CII | IP65<br>IP44 Plug | 4kg | 83x83x5cm | INC. |

|        |       |     |                  |
|--------|-------|-----|------------------|
|        |       |     |                  |
| 516341 | flexi | LED | Ø117cm 10-12-14m |

|     |      |     |                   |       |             |      |
|-----|------|-----|-------------------|-------|-------------|------|
| W   |      |     |                   |       |             |      |
| 54W | 230V | CII | IP65<br>IP44 Plug | 6,3kg | 122x122x5cm | INC. |

|        |       |     |        |
|--------|-------|-----|--------|
|        |       |     |        |
| 510165 | flexi | LED | Ø117cm |

|     |      |     |                   |     |             |      |
|-----|------|-----|-------------------|-----|-------------|------|
| W   |      |     |                   |     |             |      |
| 54W | 230V | CII | IP65<br>IP44 Plug | 6kg | 122x122x5cm | INC. |

|          |       |     |                  |
|----------|-------|-----|------------------|
|          |       |     |                  |
| N 597364 | flexi | LED | Ø200cm 16-18-20m |

|     |      |     |                   |        |             |      |
|-----|------|-----|-------------------|--------|-------------|------|
| W   |      |     |                   |        |             |      |
| 96W | 230V | CII | IP65<br>IP44 Plug | 11,8kg | 205x205x5cm | INC. |





|   |   |   |   |   |   |   |
|---|---|---|---|---|---|---|
|  |  |  |   |   |   |   |
| 510189  | <b>flexiLED</b>   | Ø76,5cm   |   |   |   |   |
| 510196  | <b>flexiLED</b>   | Ø76,5cm   |   |   |   |   |
| <b>W</b>  |  |  |  |  |  |  |
| 27W   | 230V  | CII   | IP65<br>IP44 Plug   | 3kg   | 82x82x5cm   | INC.  |

|   |   |   |   |   |   |   |
|---|---|---|---|---|---|---|
|  |  |  |   |   |   |   |
| 510301  | <b>flexiLED</b>   | Ø85cm   |   |   |   |   |
| 510318  | <b>flexiLED</b>   | Ø85cm   |   |   |   |   |
| <b>W</b>  |    |  |  |  |  |  |
| 15W   | 230V  | CII   | IP65<br>IP44 Plug   | 2,5kg   | 90x90x5cm   | INC.  |

|   |   |   |   |   |   |   |
|---|---|---|---|---|---|---|
|  |  |  |   |   |   |   |
| 510219  | <b>flexiLED</b>   | Ø118cm  |   |   |   |   |
| 510226  | <b>flexiLED</b>   | Ø118cm  |   |   |   |   |
| <b>W</b>  |  |  |  |  |  |  |
| 42W   | 230V  | CII   | IP65<br>IP44 Plug   | 4kg   | 123x123x5cm   | INC.  |

|   |   |   |   |   |   |   |
|---|---|---|---|---|---|---|
|  |  |  |   |   |   |   |
| 510332  | <b>flexiLED</b>   | Ø121cm  |   |   |   |   |
| 510349  | <b>flexiLED</b>   | Ø121cm  |   |   |   |   |
| <b>W</b>  |    |  |  |  |  |  |
| 21W   | 230V  | CII   | IP65<br>IP44 Plug   | 3kg   | 126x126x5cm   | INC.  |

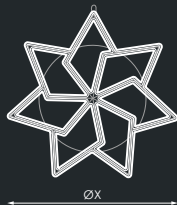

# Reno Double Neon

180cm



|        |      |                   |                   |             |      |
|--------|------|-------------------|-------------------|-------------|------|
|        |      |                   |                   |             |      |
| 487511 |      | flexi DOUBLE NEON |                   |             |      |
| W      |      |                   |                   |             |      |
| 117W   | 230V | CII               | IP54<br>IP44 Plug | 186x116x5cm | INC. |

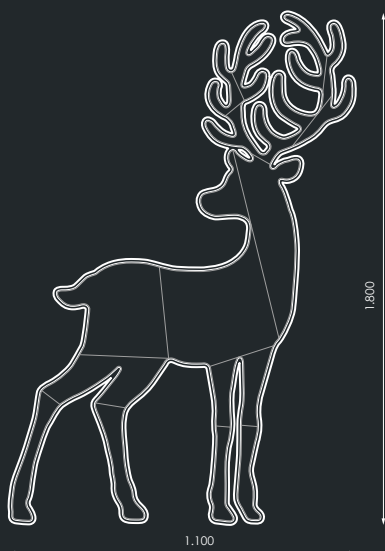

# Reno Double Neon

140cm

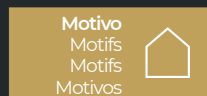

|        |      |                   |                   |            |      |
|--------|------|-------------------|-------------------|------------|------|
|        |      |                   |                   |            |      |
| 487528 |      | flexi DOUBLE NEON |                   |            |      |
| W      |      |                   |                   |            |      |
| 90W    | 230V | CII               | IP54<br>IP44 Plug | 146x90x5cm | INC. |







MADE IN SPAIN  
Desing by PRILUX

# Arkaid



MADE IN SPAIN  
Desing by PRILUX

# Gift Box

## Loop II



Motivo  
Motifs  
Motifs  
Motivos



Motivo  
Motifs  
Motifs  
Motivos



A

B

C



|        |      | 1           | 2                 |                 |
|--------|------|-------------|-------------------|-----------------|
| 415101 | A    | flexi LED   | flexi LED         | STRING PLUS LED |
| 488778 | B    | flexi LED   | flexi LED         | STRING PLUS LED |
| W      | ⚡    | □           | ⊙                 | ⊙               |
| 44W    | 230V | CII         | IP65<br>IP44 Plug | 5kg             |
|        |      | 120x120x5cm |                   | INC.            |

|        |      | 1           | 2                 |                       |
|--------|------|-------------|-------------------|-----------------------|
| 442930 | A    | flexi LED   | flexi LED         | STRING PLUS LED TAPIZ |
| 442947 | B    | flexi LED   | flexi LED         | STRING PLUS LED TAPIZ |
| 442954 | C    | flexi LED   | flexi LED         | STRING PLUS LED TAPIZ |
| W      | ⚡    | □           | ⊙                 | ⊙                     |
| 97W    | 230V | CII         | IP65<br>IP44 Plug | 9kg                   |
|        |      | 153x190x5cm |                   | INC. 10mm             |

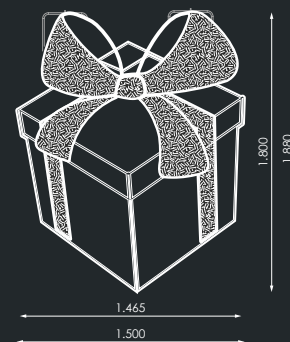
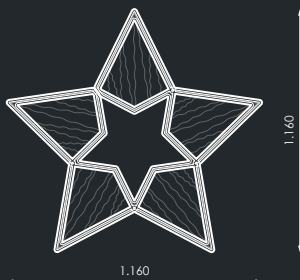

[GRÁFICOS: Unidades en mm/ GRAPHICS: Units in mm/ GRAPHIQUES: Unités en mm/ GRÁFICOS: Unidades em mm]

# Gift I



MADE IN SPAIN  
Desing by PRILUX

# Star Flake



MADE IN SPAIN  
Desing by PRILUX

Motivo  
Motifs  
Motifs  
Motivos

Motivo  
Motifs  
Motifs  
Motivos

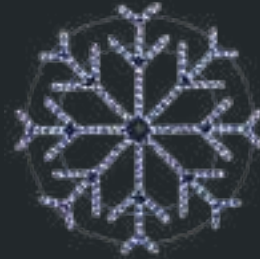

A B C



|        |      |                 |                   |       |           |      |
|--------|------|-----------------|-------------------|-------|-----------|------|
|        |      |                 |                   |       |           |      |
| 194037 | A    | flexi LED Ø80cm |                   |       |           |      |
| 194013 | B    | flexi LED Ø80cm |                   |       |           |      |
| 194044 | C    | flexi LED Ø80cm |                   |       |           |      |
| W      | ⚡    | 📏               | 🔌                 | 🏋️    | 📦         | 🔌    |
| 33W    | 230V | CII             | IP65<br>IP44 Plug | 2,5kg | 83x83x5cm | INC. |

|        |      |               |                           |       |             |      |      |
|--------|------|---------------|---------------------------|-------|-------------|------|------|
|        |      |               |                           |       |             |      |      |
| 375726 | A    | flexi LED LED | STRING PLUS LED LED TAPIZ |       |             |      |      |
| 375696 | B    | flexi LED LED | STRING PLUS LED LED TAPIZ |       |             |      |      |
| 375733 | C    | flexi LED LED | STRING PLUS LED LED TAPIZ |       |             |      |      |
| W      | ⚡    | 📏             | 🔌                         | 🏋️    | 📦           | 🔌    | 📏    |
| 63W    | 230V | CII           | IP65<br>IP44 Plug         | 8,5kg | 120x120x5cm | INC. | 10mm |

|        |      |                  |                   |       |             |      |
|--------|------|------------------|-------------------|-------|-------------|------|
|        |      |                  |                   |       |             |      |
| 194068 | A    | flexi LED Ø120cm |                   |       |             |      |
| 194051 | B    | flexi LED Ø120cm |                   |       |             |      |
| 194075 | C    | flexi LED Ø120cm |                   |       |             |      |
| W      | ⚡    | 📏                | 🔌                 | 🏋️    | 📦           | 🔌    |
| 51W    | 230V | CII              | IP65<br>IP44 Plug | 4,5kg | 123x123x5cm | INC. |

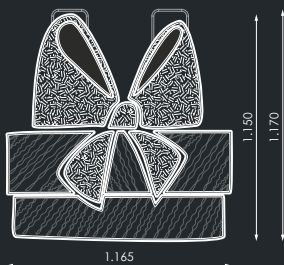



MADE IN SPAIN  
Desing by PRILUX

# Wake

# Tulip



Motivo  
Motifs  
Motifs  
Motivos



Motivo  
Motifs  
Motifs  
Motivos



A B C



A B C



|        |   |          | W   |
|--------|---|----------|-----|
|        | □ |          |     |
| 510363 | A | flexiLED | 15W |
| 510370 | B | flexiLED | 15W |
| 510387 | C | flexiLED | 23W |

|      |     |                   |       |           |      |
|------|-----|-------------------|-------|-----------|------|
| ⚡    | □   | ⦿                 | ⚖     | 📦         | 🔌    |
| 230V | CII | IP65<br>IP44 Plug | 1,7kg | 57x57x5cm | INC. |

|        |   |          | W   |
|--------|---|----------|-----|
|        | □ |          |     |
| 510394 | A | flexiLED | 18W |
| 510400 | B | flexiLED | 18W |
| 510417 | C | flexiLED | 28W |

|      |     |                   |       |           |      |
|------|-----|-------------------|-------|-----------|------|
| ⚡    | □   | ⦿                 | ⚖     | 📦         | 🔌    |
| 230V | CII | IP65<br>IP44 Plug | 1,7kg | 55x55x5cm | INC. |



[GRÁFICOS: Unidades en mm/ GRÁFICOS: Units in mm/ GRAPHIQUES: Unités en mm/ GRÁFICOS: Unidades em mm]

# Fly



MADE IN SPAIN  
Desing by PRILUX

# Tear



MADE IN SPAIN  
Desing by PRILUX

Motivo  
Motifs  
Motifs  
Motivos



Motivo  
Motifs  
Motifs  
Motivos



A B C



A B C

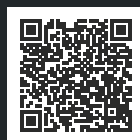

|        | 1 | 2         | W   |
|--------|---|-----------|-----|
| 510424 | A | flexi LED | 24W |
| 510431 | B | flexi LED | 24W |
| 510448 | C | flexi LED | 46W |

|      |     |                   |       |           |      |
|------|-----|-------------------|-------|-----------|------|
|      |     |                   |       |           |      |
| 230V | CII | IP65<br>IP44 Plug | 2,1kg | 58x68x5cm | INC. |



|        |   | W             |
|--------|---|---------------|
| 510455 | A | flexi LED 9W  |
| 510462 | B | flexi LED 9W  |
| 510479 | C | flexi LED 14W |

|      |     |                   |     |           |      |
|------|-----|-------------------|-----|-----------|------|
|      |     |                   |     |           |      |
| 230V | CII | IP65<br>IP44 Plug | 1kg | 55x45x5cm | INC. |





# Star Mini Double

# Star Mini Double Neon



|        | 1 | 2         |           |
|--------|---|-----------|-----------|
| 412759 | A | flexi LED | flexi LED |
| 412766 | B | flexi LED | flexi LED |
| 412773 | C | flexi LED | flexi LED |

|      |      |     |                   |     |           |      |
|------|------|-----|-------------------|-----|-----------|------|
| W    | ⚡    | □   | ⊙                 | Ⓚ   | 📦         | ⏚    |
| 5,9W | 230V | CII | IP65<br>IP44 Plug | 1kg | 35x35x5cm | INC. |

|        | 1 | 2         |           |
|--------|---|-----------|-----------|
| 412810 | A | flexi LED | flexi LED |
| 412827 | B | flexi LED | flexi LED |
| 412834 | C | flexi LED | flexi LED |

|       |      |     |                   |       |           |      |
|-------|------|-----|-------------------|-------|-----------|------|
| W     | ⚡    | □   | ⊙                 | Ⓚ     | 📦         | ⏚    |
| 11,2W | 230V | CII | IP65<br>IP44 Plug | 1,5kg | 65x65x5cm | INC. |



| 486217 | A | flexi DOUBLE NEON LED |
|--------|---|-----------------------|
| 489195 | B | flexi DOUBLE NEON LED |
| 489201 | C | flexi DOUBLE NEON LED |
| 489188 | D | flexi DOUBLE NEON LED |

|     |      |     |                   |     |           |      |
|-----|------|-----|-------------------|-----|-----------|------|
| W   | ⚡    | □   | ⊙                 | Ⓚ   | 📦         | ⏚    |
| 18W | 230V | CII | IP65<br>IP44 Plug | 1kg | 53x53x5cm | INC. |



# Double Star Flashing



MADE IN SPAIN  
Desing by PRILUX

# Sphere Mini 2D



MADE IN SPAIN  
Desing by PRILUX

Motivo  
Motifs  
Motifs  
Motivos

Motivo  
Motifs  
Motifs  
Motivos



|        |   | 1         | 2             |
|--------|---|-----------|---------------|
| 412865 | A | flexi LED | flexi LED LED |
| 412872 | B | flexi LED | flexi LED LED |
| 412889 | C | flexi LED | flexi LED LED |
| 412896 | D | flexi LED | flexi LED LED |

  

|     |      |     |                   |     |           |      |
|-----|------|-----|-------------------|-----|-----------|------|
| W   | ⚡    | □   | ⊙                 | ⚖   | 📦         | 🔌    |
| 18W | 230V | CII | IP65<br>IP44 Plug | 1kg | 35x35x5cm | INC. |

| 416078 | A | STRING PLUS | LED LED |
|--------|---|-------------|---------|
| 416061 | B | STRING PLUS | LED LED |
| 497374 | C | STRING PLUS | LED LED |

  

|    |      |     |                   |     |           |      |
|----|------|-----|-------------------|-----|-----------|------|
| W  | ⚡    | □   | ⊙                 | ⚖   | 📦         | 🔌    |
| 3W | 230V | CII | IP65<br>IP44 Plug | 1kg | 50x50x5cm | INC. |

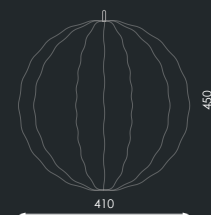

# Alpha con Movimiento

Motivo  
Motifs  
Motifs  
Motivos

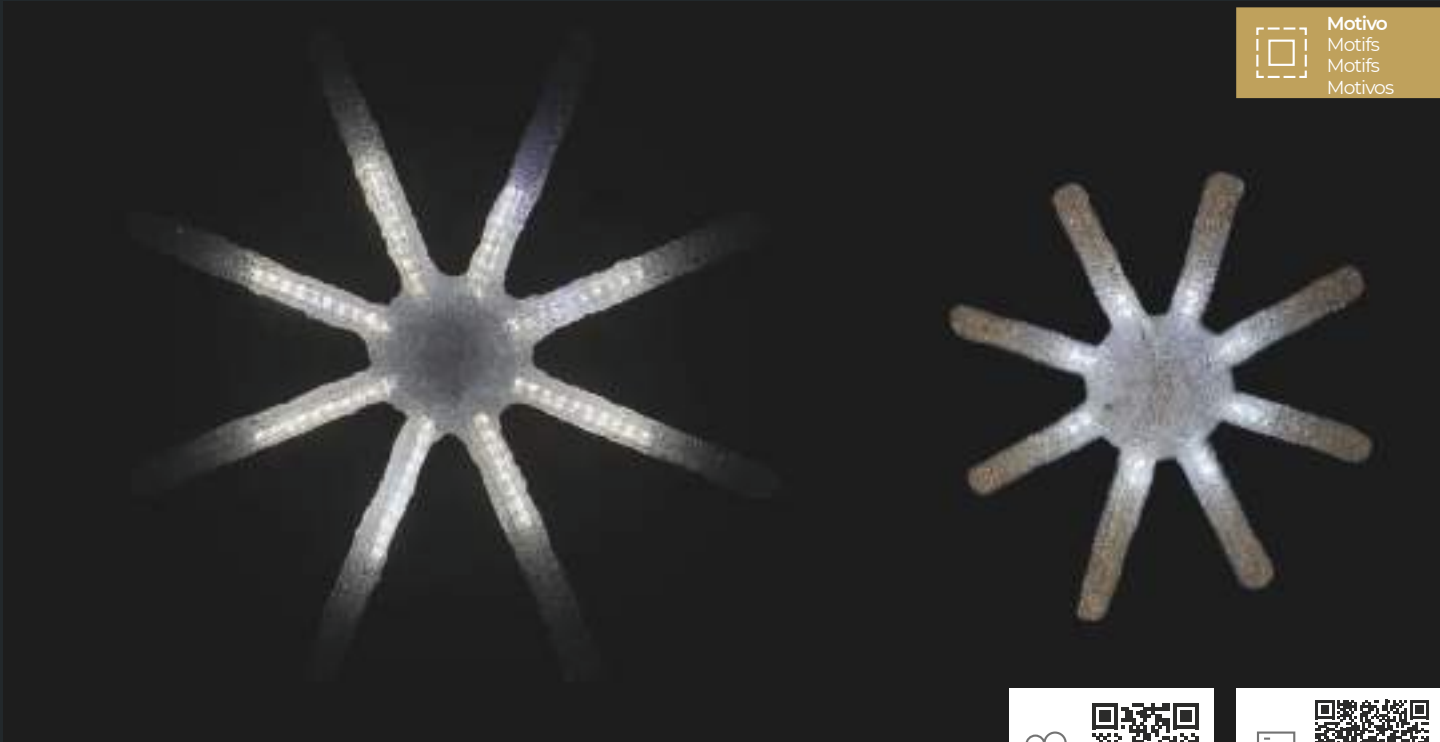

|        |      |     |      |     |             |         |
|--------|------|-----|------|-----|-------------|---------|
|        |      |     |      |     |             |         |
| 566865 |      |     |      |     |             |         |
| W      |      |     |      |     |             |         |
| 7W     | 230V | CII | IP65 | 1kg | 43,5x43x4cm | NO INC. |

|        |      |     |      |       |           |         |
|--------|------|-----|------|-------|-----------|---------|
|        |      |     |      |       |           |         |
| 566858 |      |     |      |       |           |         |
| W      |      |     |      |       |           |         |
| 2,5W   | 230V | CII | IP65 | 0,7kg | 28x28x4cm | NO INC. |

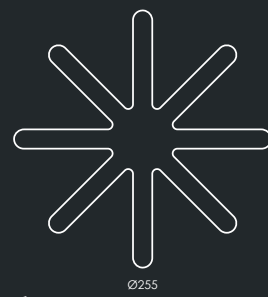
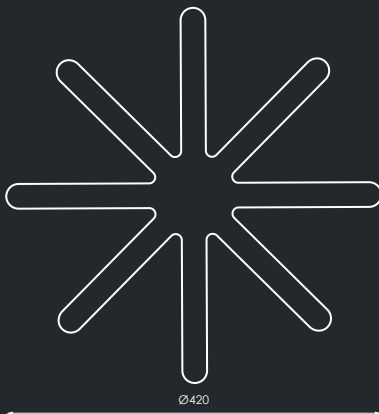

Accesorios (NO Incluidos) / Accessoires (NOT Included) / Accessories (NON Inclus) / Acessórios (NÃO Incluso)



193078

Cable Alimentación Sin Rectificador

# Red Loop

# Gold Star

Pmma



Motivo  
Motifs  
Motifs  
Motivos

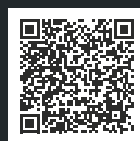

Motivo  
Motifs  
Motifs  
Motivos

|   |  |  |   |   |   |   |
|---|--|--|---|---|---|---|
|  |               |                     |   |   |   |   |
| 566452  | <b>flexi</b>  | STRING <b>PLUS</b>  |   |   |   |   |
|  |               |                     |  |  |  |  |
| 9W  | 230V   | CII  | IP65<br>IP44 Plug   | 2,3kg   | 55x50x5cm   | INC.  |

|   |  |   |   |   |   |   |
|---|--|---|---|---|---|---|
|  |   |  |   |   |   |   |
| 566445  | <b>flexi</b>   | PMMA  |   |   |   |   |
|  |   |  |  |  |  |  |
| 13W   | 230V   | CII   | IP65<br>IP44 Plug   | 5kg   | 75x72x5cm   | INC.  |



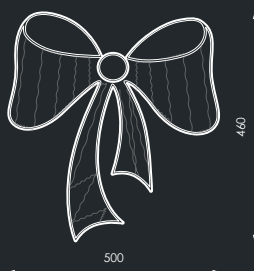

# Star 8 puntas

## Pmma



Motivo  
Motifs  
Motifs  
Motivos



# Star 8 puntas

## Doble



Motivo  
Motifs  
Motifs  
Motivos



|          |                 |      |                   |     |             |      |
|----------|-----------------|------|-------------------|-----|-------------|------|
|          |                 |      |                   |     |             |      |
| 442626   | <b>flexiLED</b> | PMMA |                   |     |             |      |
| 442633   | <b>flexiLED</b> | PMMA |                   |     |             |      |
| <b>W</b> |                 |      |                   |     |             |      |
| 12W      | 230V            | CII  | IP65<br>IP44 Plug | 2kg | 44x54x3,5cm | INC. |

|          |                 |                 |                   |     |             |      |
|----------|-----------------|-----------------|-------------------|-----|-------------|------|
|          |                 |                 |                   |     |             |      |
| 442664   | <b>flexiLED</b> | <b>flexiLED</b> |                   |     |             |      |
| <b>W</b> |                 |                 |                   |     |             |      |
| 11W      | 230V            | CII             | IP65<br>IP44 Plug | 2kg | 76x98x3,5cm | INC. |



# Ball Mini



MADE IN SPAIN  
Desing by PRILUX

Motivo  
Motifs  
Motifs  
Motivos

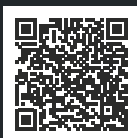

A



B



C



194204

A

flexiLED

194211

B

flexiLED

194242

C

flexiLED

W



16W

230V

CII

IP65  
IP44 Plug

1kg

53x53x5cm

INC.



# Mini Snow

# Star Flake Mini

Motivo  
Motifs  
Motifs  
Motivos

Motivo  
Motifs  
Motifs  
Motivos



A B C



A B C



|        |      |     |                   |     |           |      |
|--------|------|-----|-------------------|-----|-----------|------|
|        |      |     |                   |     |           |      |
| 194457 | A    |     |                   |     |           |      |
| 194426 | B    |     |                   |     |           |      |
| 194433 | C    |     |                   |     |           |      |
| W      |      |     |                   |     |           |      |
| 15W    | 230V | CII | IP65<br>IP44 Plug | 2kg | 55x55x3cm | INC. |

|        |      |     |                   |     |           |      |
|--------|------|-----|-------------------|-----|-----------|------|
|        |      |     |                   |     |           |      |
| 195164 | A    |     |                   |     |           |      |
| 195171 | B    |     |                   |     |           |      |
| 195188 | C    |     |                   |     |           |      |
| W      |      |     |                   |     |           |      |
| 15W    | 230V | CII | IP65<br>IP44 Plug | 2kg | 55x55x3cm | INC. |

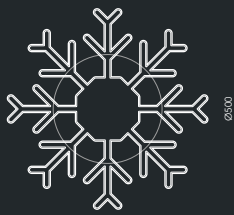

[GRÁFICOS: Unidades en mm/ GRAPHICS: Units in mm/ GRAPHIQUES: Unités en mm/ GRÁFICOS: Unidades en mm]



L'Alcudia  
Valencia

# Ring Ribbon

Motivo  
Motifs  
Motifs  
Motivos



A



B



| Barcode | Model | Product Name      | LED | Dimensions |
|---------|-------|-------------------|-----|------------|
| 487535  | A     | flexi DOUBLE NEON | LED | Ø32cm      |
| 487542  | B     | flexi DOUBLE NEON | LED | Ø32cm      |

| W  | V    | Class | IP   | Weight | Dimensions | INC. |
|----|------|-------|------|--------|------------|------|
| 9W | 230V | CII   | IP20 | 1kg    | 35x35x5cm  | 6m   |

| Barcode | Model | Product Name      | LED | Dimensions |
|---------|-------|-------------------|-----|------------|
| 487559  | A     | flexi DOUBLE NEON | LED | Ø64cm      |
| 487566  | B     | flexi DOUBLE NEON | LED | Ø64cm      |

| W   | V    | Class | IP   | Weight | Dimensions | INC. |
|-----|------|-------|------|--------|------------|------|
| 18W | 230V | CII   | IP20 | 2kg    | 67x67x5cm  | 6m   |

| Barcode | Model | Product Name      | LED | Dimensions |
|---------|-------|-------------------|-----|------------|
| 487573  | A     | flexi DOUBLE NEON | LED | Ø95,5cm    |
| 487580  | B     | flexi DOUBLE NEON | LED | Ø95,5cm    |

| W   | V    | Class | IP   | Weight | Dimensions | INC. |
|-----|------|-------|------|--------|------------|------|
| 27W | 230V | CII   | IP20 | 3kg    | 99x99x5cm  | 6m   |



## Aviso / Warning / Avertissement / Aviso

Ñ/ Para colocar este producto en el exterior, se necesita el cable de alimentación IP44.

E/ To place this product outdoors, the IP44 power cable is required.

F/ Pour placer ce produit à l'extérieur, le câble d'alimentation IP44 est requis.

P/ Para colocar este produto ao ar livre, é necessário o cabo de alimentação IP44.

## Bajo pedido / On request / Sur commande / A pedido



Cable alimentación IP44



# Accesorios

Accessories

Accessoires

Acessórios

PIE VERTICAL

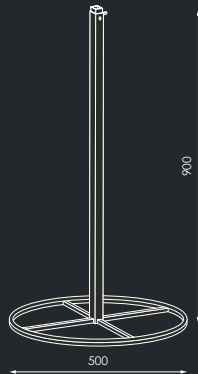

480826



Aluminio



95-165cm

BOLSAS BRIDAS

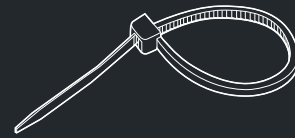

600118

Bl

Blanco

2,5x100mm

100ud

600125

Bl

Blanco

3,5x140mm

100ud

600132

Bl

Blanco

3,6x200mm

100ud

600149

Bl

Blanco

4,8x300mm

100ud

Filtro UV de protección/ UV protection filter/ Filtre anti-UV/ Filtro de proteção UV

CORREA AMARRE CON CIERRE

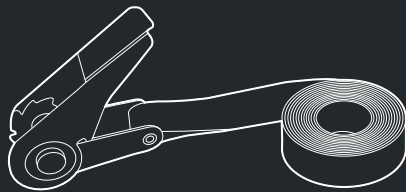

600156

Gr

Gris

1m

FIJACIÓN A POSTE 20-25MM

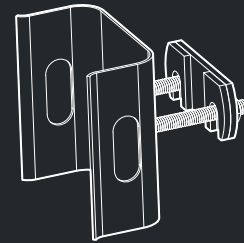

600194

Con goma protectora

BRAZO PARA MOTIVOS CALLE/FACHADA/MINI

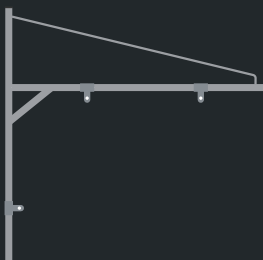

600163

30-60cm

90x90cm

600170

60-120cm

130x130cm

NIVELADOR

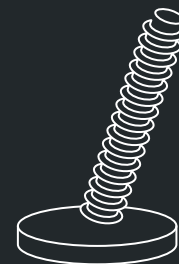

521000

[GRÁFICOS: Unidades en mm/ GRAPHICS: Units in mm/ GRAPHIQUES: Unités en mm/ GRÁFICOS: Unidades em mm]

# Cone String



MADE IN SPAIN  
Desing by PRILUX

Motivo  
Motifs  
Motifs  
Motivos

3D

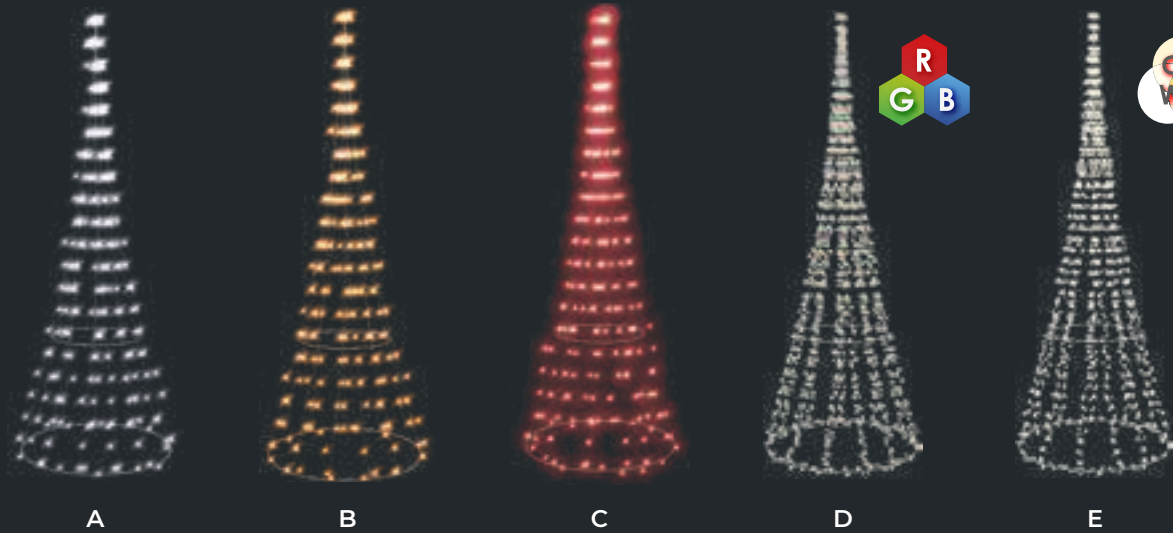

Ø50x150cm

|        |   |                 |     | W   |
|--------|---|-----------------|-----|-----|
| 444804 | A | STRING PLUS LED | LED | 18W |
| 444811 | B | STRING PLUS LED | LED | 18W |
| 444828 | C | STRING PLUS LED | LED | 18W |
| 488891 | D | STRING PLUS LED | LED | 28W |
| 510547 | E | STRING PLUS LED | LED | 28W |

|     |      |                   |     |             |      |
|-----|------|-------------------|-----|-------------|------|
|     |      |                   |     |             |      |
| 24V | CIII | IP65<br>IP44 Plug | 5kg | 155x52x52cm | INC. |

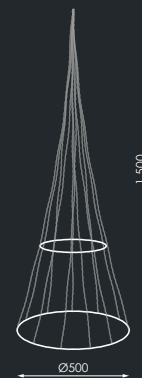

Ø100x250cm

|        |   |                 |     | W   |
|--------|---|-----------------|-----|-----|
| 416085 | A | STRING PLUS LED | LED | 36W |
| 444903 | B | STRING PLUS LED | LED | 36W |
| 488921 | D | STRING PLUS LED | LED | 46W |
| 510561 | E | STRING PLUS LED | LED | 46W |

|     |      |                   |     |               |      |
|-----|------|-------------------|-----|---------------|------|
|     |      |                   |     |               |      |
| 24V | CIII | IP65<br>IP44 Plug | 9kg | 255x105x105cm | INC. |

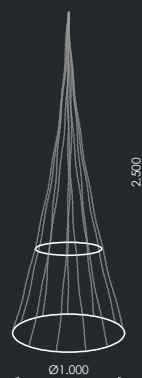



MADE IN SPAIN  
Desing by PRILUX

# Cone Loop

3D Motivo  
Motifs  
Motifs  
Motivos

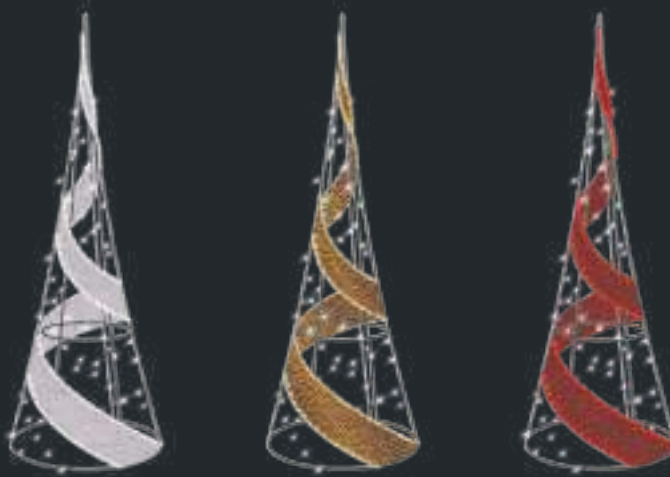

A

B

C



Ø60x150cm

|        | 1   | 2                         |                |
|--------|-----|---------------------------|----------------|
| 444651 | A   | flexi LED STRING PLUS LED | TAPIZ          |
| 444668 | B   | flexi LED STRING PLUS LED | TAPIZ          |
| 444675 | C   | flexi LED STRING PLUS LED | TAPIZ          |
| W      | 21W | 24V                       | CIII           |
|        |     |                           | IP65 IP44 Plug |
|        |     |                           | 5kg            |
|        |     |                           | 155x52x52cm    |
|        |     |                           | INC.           |

Ø100x250cm

|        | 1   | 2                         |                |
|--------|-----|---------------------------|----------------|
| 444750 | A   | flexi LED STRING PLUS LED | TAPIZ          |
| 444767 | B   | flexi LED STRING PLUS LED | TAPIZ          |
| 444774 | C   | flexi LED STRING PLUS LED | TAPIZ          |
| W      | 48W | 24V                       | CIII           |
|        |     |                           | IP65 IP44 Plug |
|        |     |                           | 15kg           |
|        |     |                           | 255x105x105cm  |
|        |     |                           | INC.           |

Ø200x450cm

|        | 1    | 2                         |                                    |
|--------|------|---------------------------|------------------------------------|
| 545655 | A    | flexi LED STRING PLUS LED | TAPIZ                              |
| 545662 | B    | flexi LED STRING PLUS LED | TAPIZ                              |
| 545679 | C    | flexi LED STRING PLUS LED | TAPIZ                              |
| W      | 140W | 24V                       | CIII                               |
|        |      |                           | IP65 IP44 Plug                     |
|        |      |                           | 35kg                               |
|        |      |                           | 1- 255x52x52cm<br>1- 205x205x205cm |
|        |      |                           | INC.                               |

[CRÁFICOS: Unidades en mm/ GRAPHICS: Units in mm/ GRAPHIQUES: Unités en mm/ GRÁFICOS: Unidades em mm]

# Cone Loop

## PVC NET



MADE IN SPAIN  
Desing by PRILUX

Motivo  
Motifs  
Motifs  
Motivos

3D

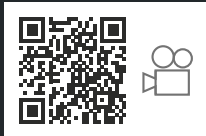
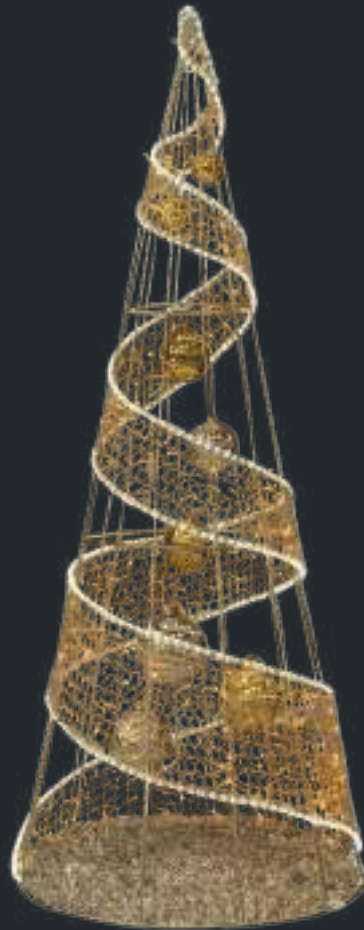

|        |          |             |                   |         |                |
|--------|----------|-------------|-------------------|---------|----------------|
|        |          |             |                   |         |                |
| 512237 | flexiLED | STRING PLUS | LED               | PVC NET | CHRISTMAS BALL |
|        |          |             |                   |         |                |
| 56W    | 24V      | CIII        | IP65<br>IP44 PLUG | 15kg    | 255x105x105cm  |
|        |          |             |                   |         | INC.           |

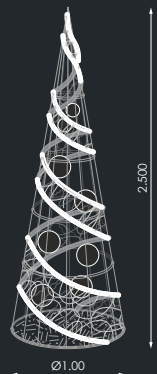





Vega de San Mateo  
Gran Canarias

# Cherry Blossom Tree

1,8m

Motivo  
Motifs  
Motifs  
Motivos

3D

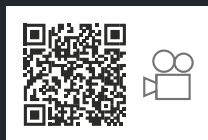
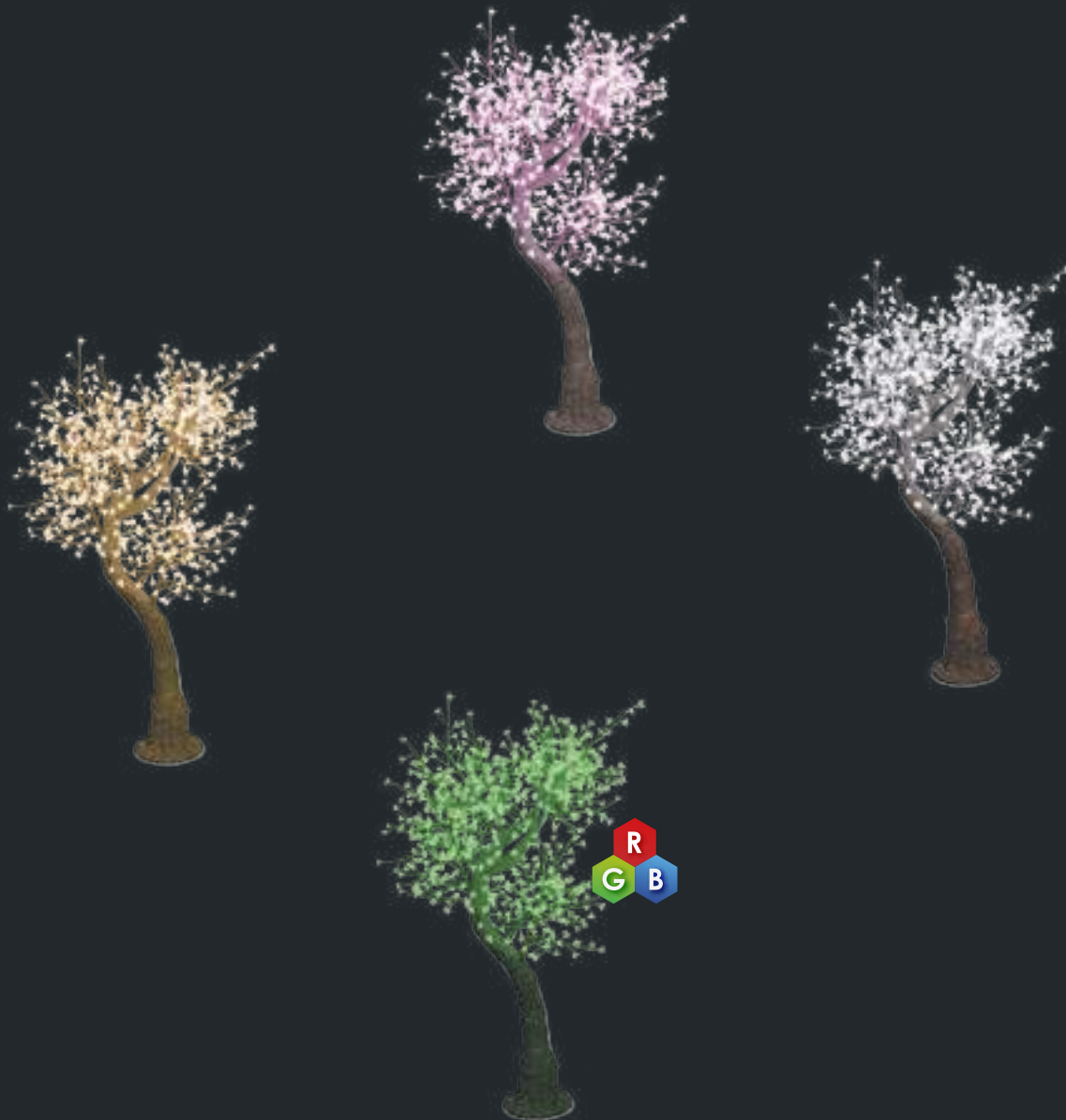

| Barcode |     | Light Bulb     |      |         |      |         |  |            |  |     |  |
|---------|-----|----------------|------|---------|------|---------|--|------------|--|-----|--|
| 210461  |     | LED            |      |         |      |         |  |            |  |     |  |
| 210478  |     | LED            |      |         |      |         |  |            |  |     |  |
| 210485  |     | LED            |      |         |      |         |  |            |  |     |  |
| 506281  |     | LED            |      |         |      |         |  |            |  |     |  |
| W       |     | Lightning Bolt |      | Diamond |      | Circles |  | Light Bulb |  | Cup |  |
| 60W     | 24V | CIII           | IP44 | 800     | INC. |         |  |            |  |     |  |

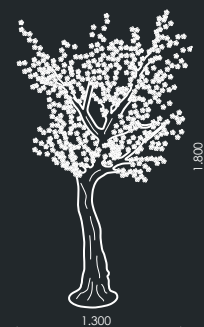



# Cherry Blossom Tree

2,8m

3D  
 Motivo  
 Motifs  
 Motifs  
 Motivos

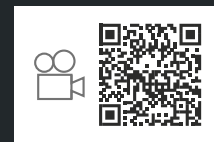

|          |        |      |      |      |      |
|----------|--------|------|------|------|------|
|          |        |      |      |      |      |
|          | 210492 |      |      |      |      |
|          | 210508 |      |      |      |      |
|          | 210515 |      |      |      |      |
|          | 506298 |      |      |      |      |
| <b>W</b> |        |      |      |      |      |
| 150W     | 24V    | CIII | IP44 | 2120 | INC. |

# Cherry Blossom Tree

3,6m

Motivo  
Motifs  
Motifs  
Motivos

3D

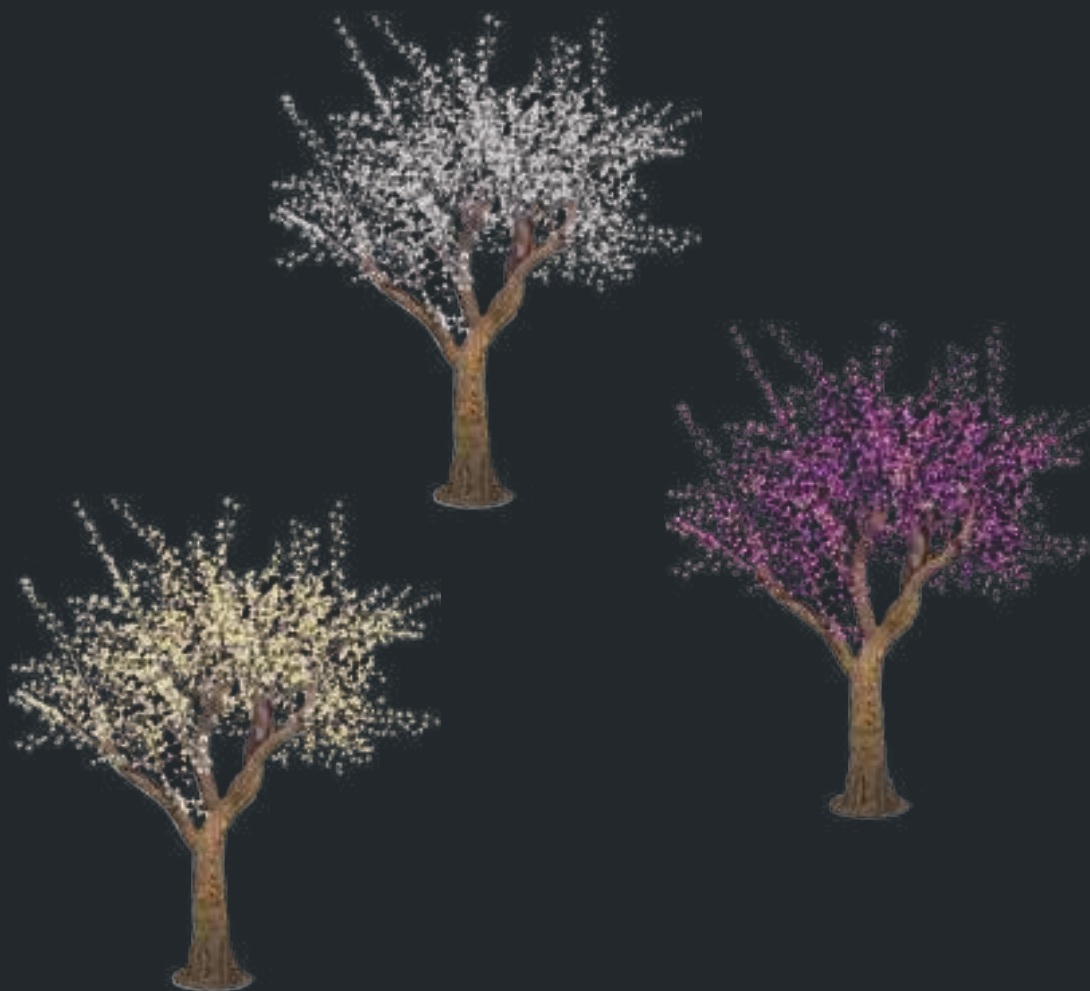

|          |        |      |      |      |      |
|----------|--------|------|------|------|------|
|          |        |      |      |      |      |
|          | 408226 |      |      |      |      |
|          | 408233 |      |      |      |      |
|          | 408240 |      |      |      |      |
| <b>W</b> |        |      |      |      |      |
| 300W     | 24V    | CIII | IP44 | 4100 | INC. |





# Cherry Blossom Tree

4,5m

3D

Motivo  
Motifs  
Motifs  
Motivos

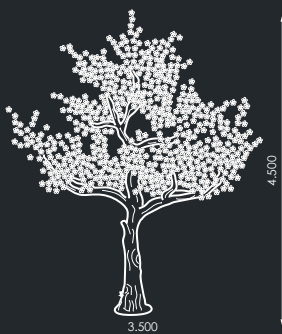

|          |        |      |      |      |      |
|----------|--------|------|------|------|------|
|          |        |      |      |      |      |
|          | 408257 |      |      |      |      |
|          | 408264 |      |      |      |      |
|          | 408271 |      |      |      |      |
| <b>W</b> |        |      |      |      |      |
| 350W     | 24V    | CIII | IP44 | 5200 | INC. |







La Almazara  
Ayto. Illescas Toledo

# Maple Tree

Motivo  
Motifs  
Motifs  
Motivos

3D



|        |     |      |      |      |      |
|--------|-----|------|------|------|------|
| 2,8m   |     |      |      |      |      |
|        |     |      |      |      |      |
| 506311 |     |      |      |      |      |
| 506328 |     |      |      |      |      |
| W      |     |      |      |      |      |
| 100W   | 24V | CIII | IP44 | 1376 | INC. |

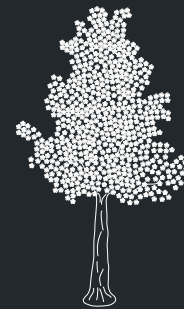

2.800

|        |     |      |      |      |      |
|--------|-----|------|------|------|------|
| 5m     |     |      |      |      |      |
|        |     |      |      |      |      |
| 506335 |     |      |      |      |      |
| 506342 |     |      |      |      |      |
| W      |     |      |      |      |      |
| 180W   | 24V | CIII | IP44 | 2924 | INC. |

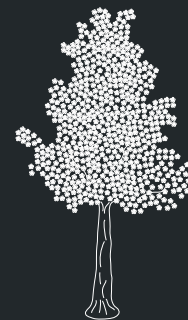

5.000

|        |     |      |      |      |      |
|--------|-----|------|------|------|------|
| 8m     |     |      |      |      |      |
|        |     |      |      |      |      |
| 506359 |     |      |      |      |      |
| 506397 |     |      |      |      |      |
| W      |     |      |      |      |      |
| 250W   | 24V | CIII | IP44 | 4000 | INC. |



8.000



# Autumn Tree

## 3,5m

3D  
 Motivo  
 Motifs  
 Motifs  
 Motivos



|          |        |      |      |      |      |
|----------|--------|------|------|------|------|
|          |        |      |      |      |      |
|          | 506434 |      |      |      |      |
|          | 506441 |      |      |      |      |
| <b>W</b> |        |      |      |      |      |
| 100W     | 24V    | CIII | IP44 | 1664 | INC. |

### Información / Information / Information / Informações

Ñ/ El código 506434 va con hoja blanca y el código 506441 va con hoja otoñal.

E/ Code 506434 goes with a white sheet and code 506441 goes with an autumn leaf.

F/ Le code 506434 va avec une feuille blanche et le code 506441 va avec une feuille d'automne.

P/ EO código 506434 acompanha uma folha em branco e o código 506441 acompanha uma folha de outono.







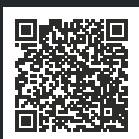

# Valley Tree

Motivo  
Motifs  
Motifs  
Motivos

3D



|   |   |   |   |   |   |
|---|---|---|---|---|---|
|  |  |   |   |   |   |
| 601498  |  |   |   |   |   |
| 601504  |  |   |   |   |   |
|  |  |  |  |  |  |
| 6W  | 24V   | CIII  | IP44  | 600   | INC.  |

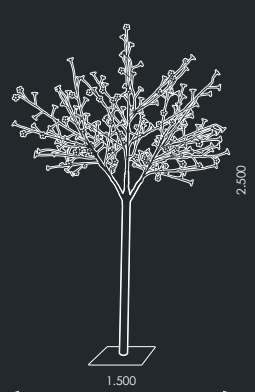

# Giant Tree



3D  
Motivo  
Motifs  
Motifs  
Motivos

CC. Plaza Norte  
Madrid

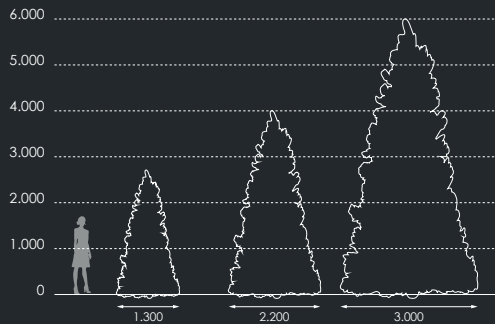

| Product Code | Height (m) | Weight (kg) | Number of Packages |
|--------------|------------|-------------|--------------------|
| 412216       | 2,7m       | 30kg        | 1                  |
| 506946       | 4m         | 44kg        | 2                  |
| 506991       | 6m         | 112kg       | 4                  |

## Componentes/Components/Composants/Componentes

Ñ/ Estructura de poste interior y base fijación de seguridad.

E/ Structure of inner pole and base with safety locking.

F/ Structure du pôle interne et base avec fermeture de sécurité.

P/ Estrutura do pólo interior e base com bloqueio de segurança.

## Información / Information / Information / Informações

Ñ/ Este producto se sirve desmontado, embalado en el número de cajas que indica la columna de embalaje. Solo se sirve el árbol, sin decoración.

E/ This product is disassembled, packed in the number of cases indicating the column packing. Only the tree is served, without decoration.

F/ Ce produit est démonté, emballé dans le nombre de cas, indiquant l'emballage de la colonne. Seul l'arbre est servi, sans décoration.

P/ Este produto é desmontado, embalado no número de casos, indicando a embalagem de coluna. Somente a árvore é servida, sem decoração.



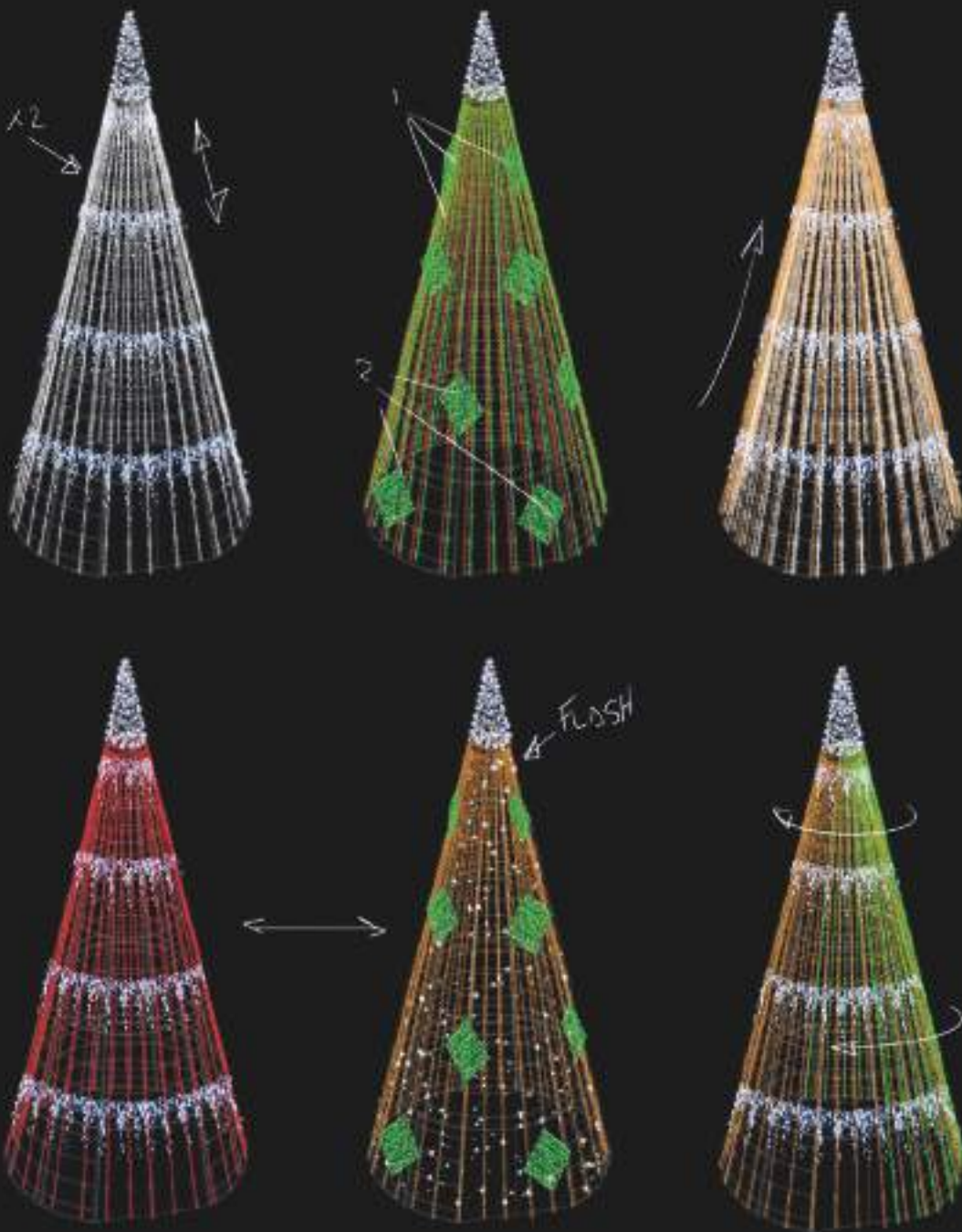

# eConcept

El nuevo sistema de control de iluminación dinámica "Prilux econcept" para árboles, fachadas y elementos 3d sincroniza música y luz para crear composiciones visuales espectaculares que aportan ritmo y movimiento a todo tipo de ambientes, espacios y eventos.

"Prilux econcept" The new dynamic lighting control system for trees, facades and 3d elements synchronizes music and light to create spectacular visual compositions that bring rhythm and movement to all types of environments, spaces and events.

"Prilux econcept" Le nouveau système de contrôle d'éclairage dynamique pour arbres, façades et éléments 3D synchronise la musique et la lumière pour créer des compositions visuelles spectaculaires qui apportent du rythme et du mouvement à tous types d'environnements, d'espaces et d'événements.

"Prilux econcept" O novo sistema dinâmico de controle de iluminação para árvores, fachadas e elementos tridimensionais sincroniza música e luz para criar composições visuais espetaculares que trazem ritmo e movimento a todos os tipos de ambientes, espaços e eventos.









# Giant Cone

## PIXELMAX



MADE IN SPAIN  
Desing by PRILUX

Motivo  
Motifs  
Motifs  
Motivos

3D



PIXELMAX



Gavá  
Barcelona

## NO TRANSITABLE

|  |  |  |  |  |  |  |  |
|---|---|---|---|---|---|---|---|
| 567374  | 4,965m  | STRING PIXELMAX   |  | 12V   | 1.030W  | 135kg   | SI  |
| 489751  | 6,945m  | STRING PIXELMAX   |  | 12V   | 1.560W  | 190kg   | SI  |
| 489768  | 8,93m   | STRING PIXELMAX   |  | 12V   | 2.520W  | 280kg   | SI  |
| 489775  | 10,92m  | STRING PIXELMAX   |  | 12V   | 3.720W  | 420kg   | SI  |
| 489782  | 12,91m  | STRING PIXELMAX   |  | 12V   | 5.160W  | 585kg   | SI  |
| 600415  | 14,90m  | STRING PIXELMAX   |  | 12V   | 6.600W  | 803kg   | SI  |



MADE IN SPAIN  
Desing by PRILUX

# Giant Cone PIXELMAX

**N**  
NEW

**3D**  
Motivo  
Motifs  
Motifs  
Motivos





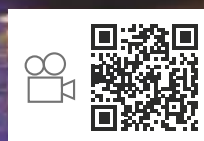



PIXELMAX



Gijón

## TRANSITABLE

|  |  |                 |  |  |  |  |  |
|---|---|-----------------|---|---|---|---|---|
| 567381  | 6,945m  | STRING PIXELMAX |  | 12V   | 1.440W  | 185kg   | SI  |
| 567398  | 8,93m   | STRING PIXELMAX |  | 12V   | 2.400W  | 275kg   | SI  |
| 567404  | 10,92m  | STRING PIXELMAX |  | 12V   | 3.600W  | 415kg   | SI  |
| 567411  | 12,91m  | STRING PIXELMAX |  | 12V   | 5.040W  | 580kg   | SI  |
| 600422  | 14,9m   | STRING PIXELMAX |  | 12V   | 6.590W  | 795kg   | SI  |
| <b>N 609340</b>   | 18,9m   | STRING PIXELMAX |  | 12V   | 10.200W   | 1.230kg   | SI  |
| 567428  | 20,9m   | STRING PIXELMAX |  | 12V   | 12.500W   | 1.436kg   | SI  |

[GRÁFICOS: Unidades en mm/ GRAPHICS: Units in mm/ GRAPHIQUES: Unités en mm/ GRÁFICOS: Unidades em mm]

# Giant Cone con Lilium

## PIXELMAX NO TRANSITABLE



MADE IN SPAIN  
Desing by PRILUX

Motivo  
Motifs  
Motifs  
Motivos

3D

N

NEW



PIXELMAX



Loeches  
Madrid



608725



14,40m



+ LILIUM

16,4m



STRING PIXELMAX



12V

W

6.600W



803kg



SI





MADE IN SPAIN  
Desing by PRILUX

# Giant Cone con Liliu

## PIXELMAX TRANSITABLE

**N**  
NEW

**3D**  
Motivo  
Motifs  
Motifs  
Motivos



PIXELMAX



Vitoria-Gasteiz  
Pais Vasco



[GRÁFICOS: Unidades en mm/ GRAPHICS: Units in mm/ GRAPHIQUES: Unités en mm/ GRÁFICOS: Unidades em mm]



581301



18,40m



+ LILIUM

20,4m



STRING PIXELMAX



12V



10,296W



1,240kg



SI





Bilbao  
Cono especial





MADE IN SPAIN  
Desing by PRILUX

# Giant Cone PIXELMAX Rings

3D Motivo  
Motifs  
Motifs  
Motivos



PIXELMAX



C.C. La Gavia  
Madrid



|        |        | + LILIUM |                 |  |          | W      |       |    |
|--------|--------|----------|-----------------|--|----------|--------|-------|----|
| 567435 | 8,33m  | 9,11m    | STRING PIXELMAX |  | 12V/230V | 1.600W | 275kg | SI |
| 567442 | 10,32m | 11,49m   | STRING PIXELMAX |  | 12V/230V | 2.075W | 415kg | SI |
| 567459 | 12,31m | 13,48m   | STRING PIXELMAX |  | 12V/230V | 3.765W | 580kg | SI |

Aviso / Warning / Avertissement / Aviso

Ñ/ Sólo será transitable el modelo de 12m.

E/ Only the 12m model will be passable.

F/ Seul le modèle 12m sera praticable.

P/ Apenas o modelo de 12m será transitável.

[GRÁFICOS: Unidades en mm/ GRÁFICOS: Units in mm/ GRÁFICOS: Unidades en mm/ GRÁFICOS: Unidades en mm]

# Giant Cone

## RGB (sin recubrimiento)



MADE IN SPAIN  
Desing by PRILUX

Motivo  
Motifs  
Motifs  
Motivos

3D

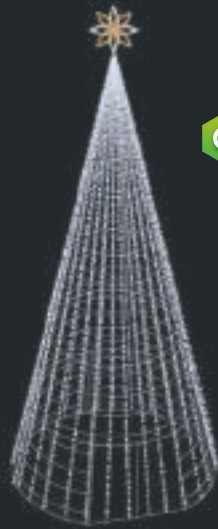

Opción de composición/ Composition option  
Option de composition/ Opção de composição



| Barcode | ↕      | ↕ + LILIUM | 💡               | ⚡    | W    | 👤/kg  | 🕒  |
|---------|--------|------------|-----------------|------|------|-------|----|
| 489799  | 6,34m  | 7,12m      | STRING PLUS LED | 230V | 250W | 141kg | NO |
| 489805  | 8,33m  | 9,11m      | STRING PLUS LED | 230V | 405W | 200kg | NO |
| 489812  | 10,32m | 11,49m     | STRING PLUS LED | 230V | 625W | 315kg | NO |
| 489829  | 12,31m | 13,48m     | STRING PLUS LED | 230V | 780W | 460kg | NO |

# Giant Cone

## RGB (sin recubrimiento)



MADE IN SPAIN  
Desing by PRILUX

Motivo  
Motifs  
Motifs  
Motivos

3D

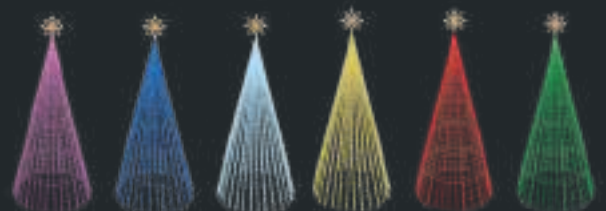
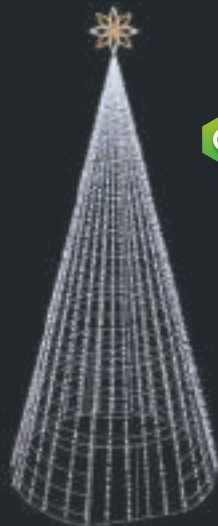

Opción de composición/ Composition option  
Option de composition/ Opção de composição



| Barcode | ↕      | ↕ + LILIUM | 💡               | ⚡    | W      | 👤/kg  | 🕒  |
|---------|--------|------------|-----------------|------|--------|-------|----|
| 600439  | 6,34m  | 7,12m      | STRING PLUS LED | 230V | 432W   | 129kg | SI |
| 600446  | 8,33m  | 9,11m      | STRING PLUS LED | 230V | 652W   | 205kg | SI |
| 600453  | 10,32m | 11,49m     | STRING PLUS LED | 230V | 937W   | 345kg | SI |
| 600460  | 12,31m | 13,48m     | STRING PLUS LED | 230V | 1.250W | 500kg | SI |





MADE IN SPAIN  
Desing by PRILUX

# Giant Cone

## CW-WW (sin recubrimiento)

3D  
Motivo  
Motifs  
Motivos

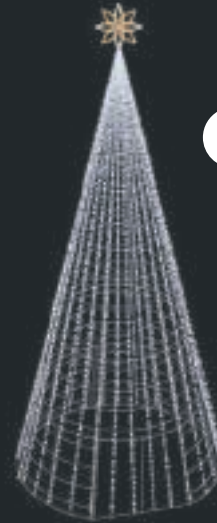
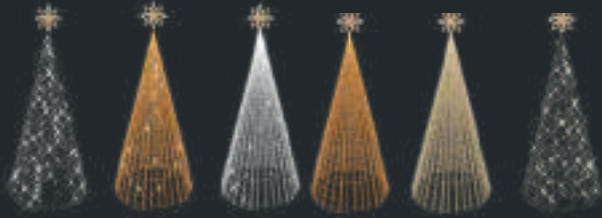

Opción de composición/ Composition option  
Option de composition/ Opção de composição

| 511612 | 6,34m  | 7,12m  | STRING <b>PLUS</b> <b>LED</b> | 230V | 250W | 141kg | NO |
|--------|--------|--------|-------------------------------|------|------|-------|----|
| 511629 | 8,33m  | 9,11m  | STRING <b>PLUS</b> <b>LED</b> | 230V | 405W | 200kg | NO |
| 511636 | 10,32m | 11,49m | STRING <b>PLUS</b> <b>LED</b> | 230V | 625W | 315kg | NO |
| 511643 | 12,31m | 13,48m | STRING <b>PLUS</b> <b>LED</b> | 230V | 780W | 460kg | NO |



MADE IN SPAIN  
Desing by PRILUX

# Giant Cone

## RGB Double Star (sin recubrimiento)

3D  
Motivo  
Motifs  
Motivos



Opción de composición/ Composition option  
Option de composition/ Opção de composição

| 511650 | 8,33m  | 9,11m  | STRING <b>PLUS</b> <b>LED</b> | Double Star | 230V | 812W   | 265kg | NO |
|--------|--------|--------|-------------------------------|-------------|------|--------|-------|----|
| 511667 | 10,32m | 11,49m | STRING <b>PLUS</b> <b>LED</b> | Double Star | 230V | 1.179W | 404kg | NO |
| 511674 | 12,31m | 13,48m | STRING <b>PLUS</b> <b>LED</b> | Double Star | 230V | 1.537W | 610kg | NO |

[GRÁFICOS: Unidades en mm/ GRAPHICS: Units in mm/ GRÁFICOS: Unidades em mm/ GRÁFICOS: Unidades em mm]

# Giant Cone

## Spiral Tapiz Rojo (sin recubrimiento)



MADE IN SPAIN  
Desing by PRILUX

Motivo  
Motifs  
Motifs  
Motivos

3D



|        | ↕      | ↕ + LILIUM | 💡               | ⚡          | ⚡    | W    | ⚖     | 🕒  |
|--------|--------|------------|-----------------|------------|------|------|-------|----|
| 511681 | 8,33m  | 9,11m      | STRING PLUS LED | TAPIZ ROJO | 230V | 439W | 260kg | NO |
| 511698 | 10,32m | 11,49m     | STRING PLUS LED | TAPIZ ROJO | 230V | 659W | 405kg | NO |
| 511704 | 12,31m | 13,48m     | STRING PLUS LED | TAPIZ ROJO | 230V | 813W | 610kg | NO |

# Giant Cone

## Spiral Gold (sin recubrimiento)



MADE IN SPAIN  
Desing by PRILUX

Motivo  
Motifs  
Motifs  
Motivos

3D



|        | ↕      | ↕ + LILIUM | 💡               | ⚡                                 | ⚡    | W     | ⚖     | 🕒  |
|--------|--------|------------|-----------------|-----------------------------------|------|-------|-------|----|
| 511711 | 8,33m  | 9,11m      | STRING PLUS LED | GUIRNALDA DORADA + LÁMAPARA FLASH | 230V | 651W  | 265kg | NO |
| 511766 | 10,32m | 11,49m     | STRING PLUS LED | GUIRNALDA DORADA + LÁMAPARA FLASH | 230V | 947W  | 415kg | NO |
| 511773 | 12,31m | 13,48m     | STRING PLUS LED | GUIRNALDA DORADA + LÁMAPARA FLASH | 230V | 1233W | 625kg | NO |



MADE IN SPAIN  
Desing by PRILUX

# Giant Cone

## String Flashing (sin recubrimiento)

**3D** Motivo  
Motifs  
Motifs  
Motivos



[GRÁFICOS: Unidades en mm/GRAPHIQUES: Units in mm/GRAPHIQUES: Unités en mm/GRÁFICOS: Unidades em mm]

|        |        |        |                    |      | <b>W</b> |       |    |
|--------|--------|--------|--------------------|------|----------|-------|----|
| 600521 | 6,34m  | 7,12m  | STRING <b>PLUS</b> | 230V | 432W     | 129kg | SI |
| 600538 | 8,33m  | 9,11m  | STRING <b>PLUS</b> | 230V | 652W     | 205kg | SI |
| 600545 | 10,32m | 11,49m | STRING <b>PLUS</b> | 230V | 934W     | 329kg | SI |
| 600552 | 12,31m | 13,48m | STRING <b>PLUS</b> | 230V | 1.242W   | 479kg | SI |
| 600569 | 6,34m  | 7,12m  | STRING <b>PLUS</b> | 230V | 432W     | 129kg | SI |
| 600576 | 8,33m  | 9,11m  | STRING <b>PLUS</b> | 230V | 652W     | 205kg | SI |
| 600583 | 10,32m | 11,49m | STRING <b>PLUS</b> | 230V | 934W     | 329kg | SI |
| 600590 | 12,31m | 13,48m | STRING <b>PLUS</b> | 230V | 1.242W   | 479kg | SI |

# Giant Cone

## Combo (sin recubrimiento)



MADE IN SPAIN  
Desing by PRILUX

Motivo  
Motifs  
Motifs  
Motivos

3D



| Barcode | Height | Width + LILIUM | Light Type      | Light Model                | Voltage | Power (W) | Weight (kg) | Control |
|---------|--------|----------------|-----------------|----------------------------|---------|-----------|-------------|---------|
| 600491  | 10,32m | 11,49m         | STRING PLUS LED | STAR FLAKE ALPHA MINI SNOW | 230V    | 1527W     | 398kg       | SI      |
| 600507  | 14,3m  | 15,47m         | STRING PLUS LED | STAR FLAKE ALPHA MINI SNOW | 230V    | 2597W     | 760kg       | SI      |
| 600514  | 18,3m  | 20,3m          | STRING PLUS LED | STAR FLAKE ALPHA MINI SNOW | 230V    | 3987W     | 1240kg      | SI      |





MADE IN SPAIN  
Desing by PRILUX

# Giant Cone

## Star Flake (sin recubrimiento)



3D Motivo  
Motifs  
Motifs  
Motivos



|        | ↔      | ↔ + LILIUM | 💡               | T          | ⚡    | W      | 📊     | 🕒  |
|--------|--------|------------|-----------------|------------|------|--------|-------|----|
| 453653 | 8,33m  | 9,11m      | STRING PLUS LED | STAR FLAKE | 230V | 1.091W | 255kg | NO |
| 453721 | 10,32m | 11,49m     | STRING PLUS LED | STAR FLAKE | 230V | 1.291W | 370kg | NO |
| 453790 | 12,31m | 13,48m     | STRING PLUS LED | STAR FLAKE | 230V | 1.827W | 558kg | NO |



MADE IN SPAIN  
Desing by PRILUX

# Giant Cone

## Stars (sin recubrimiento)



3D Motivo  
Motifs  
Motifs  
Motivos

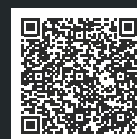

|        | ↔      | ↔ + LILIUM | 💡               | T            | ⚡    | W      | 📊     | 🕒  |
|--------|--------|------------|-----------------|--------------|------|--------|-------|----|
| 489942 | 8,33m  | 9,11m      | STRING PLUS LED | 21 ESTRELLAS | 230V | 1.085W | 260kg | SI |
| 489959 | 10,32m | 11,49m     | STRING PLUS LED | 29 ESTRELLAS | 230V | 1.565W | 402kg | SI |
| 467520 | 12,31m | 13,48m     | STRING PLUS LED | 37 ESTRELLAS | 230V | 2.005W | 591kg | SI |

[GRÁFICOS: Unidades en mm/ GRAPHICS: Units in mm/GRÁFICOS: Unidades en mm/GRÁFICOS: Unidades en mm]

# Giant Cone

## Ice (con recubrimiento)



MADE IN SPAIN  
Desing by PRILUX

Motivo  
Motifs  
Motifs  
Motivos

3D



| Barcode | ↕      | ↕ + LILIUM | 💡               | 🔧                               | ⚡    | W      | 📊 kg    | 🕒  |
|---------|--------|------------|-----------------|---------------------------------|------|--------|---------|----|
| 600477  | 8,33m  | 9,11m      | STRING PLUS LED | TAPIZ AZUL + STAR FLAKE + ALPHA | 230V | 713W   | 277,1kg | SI |
| 600484  | 10,32m | 11,49m     | STRING PLUS LED | TAPIZ AZUL + STAR FLAKE + ALPHA | 230V | 1.130W | 460kg   | SI |

# Giant Cone

## Tears (con recubrimiento)



MADE IN SPAIN  
Desing by PRILUX

Motivo  
Motifs  
Motifs  
Motivos

3D



| Barcode | ↕      | ↕ + LILIUM | 💡               | 🔧                              | ⚡    | W      | 📊 kg  | 🕒  |
|---------|--------|------------|-----------------|--------------------------------|------|--------|-------|----|
| 567466  | 6,34m  | 7,12m      | STRING PLUS LED | TEARS WW + RED METALLIC BRANCH | 230V | 558W   | 208kg | NO |
| 567473  | 8,33m  | 9,11m      | STRING PLUS LED | TEARS WW + RED METALLIC BRANCH | 230V | 838W   | 361kg | NO |
| 567480  | 10,32m | 11,49m     | STRING PLUS LED | TEARS WW + RED METALLIC BRANCH | 230V | 1.212W | 534kg | NO |



MADE IN SPAIN  
Desing by PRILUX

# Basic Gift Box Cerrada

**N**  
NEW

**3D**  
Motivo  
Motifs  
Motifs  
Motivos

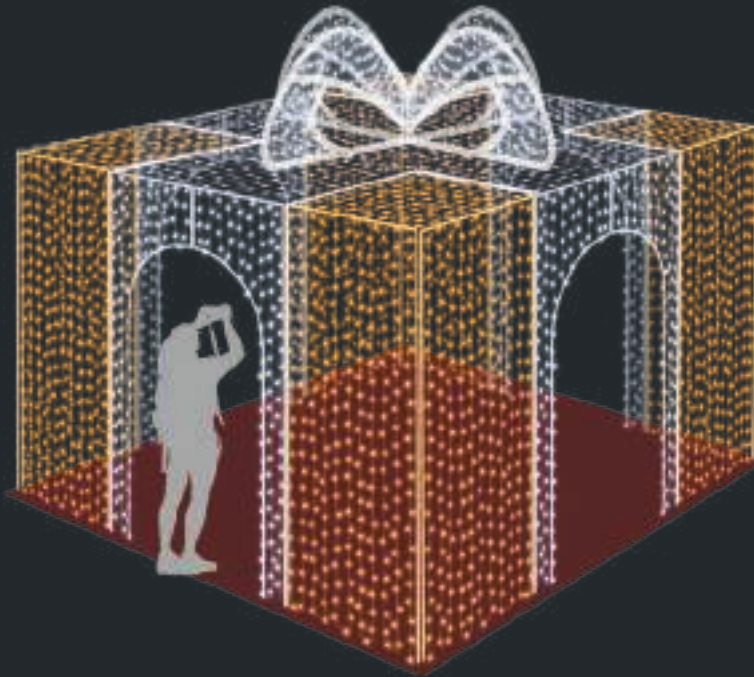

[GRÁFICOS: Unidades en mm/ GRAPHICS: Units in mm/ GRAPHIQUES: Unités en mm/ GRÁFICOS: Unidades em mm]

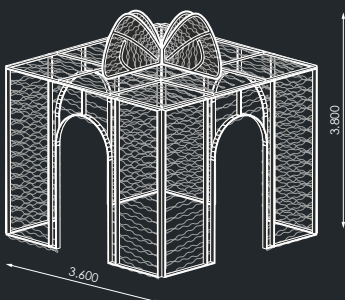

|        |          |               |                 | 1               | 2   |      | W     |  |
|--------|----------|---------------|-----------------|-----------------|-----|------|-------|--|
| 600279 | 3,6x3,8m | flexi LED LED | STRING PLUS LED | STRING PLUS LED | 24V | 580W | 295kg |  |
| 600286 | 3,6x3,8m | flexi LED LED | STRING PLUS LED | STRING PLUS LED | 24V | 580W | 295kg |  |

# Basic Gift

## Box



MADE IN SPAIN  
Desing by PRILUX

Motivo  
Motifs  
Motifs  
Motivos

3D



Santa Cruz de Tenerife  
Canarias



PIXELMAX



| Code   | Dimensions   | String Type     | Light Type      | Voltage | Power  | Weight |
|--------|--------------|-----------------|-----------------|---------|--------|--------|
| 565134 | 3,4x3,4x3,4m | STRING PIXELMAX | LED             | 12V     | 1.800W | 150kg  |
| 565127 | 3,4x3,4x3,4m | STRING PLUS     | STRING PLUS LED | 24V     | 240W   | 130kg  |
| 565141 | 3,4x3,4x3,4m | STRING PLUS     | STRING PLUS LED | 24V     | 240W   | 130kg  |

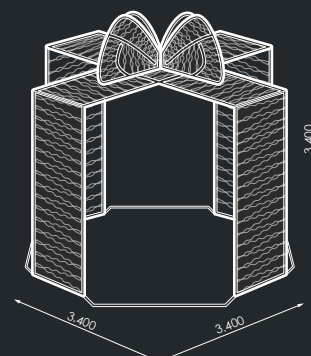





MADE IN SPAIN  
Desing by PRILUX

# Big Gift Box

3D  
Motivo  
Motifs  
Motifs  
Motivos



Valsequillo  
Gran Canarias

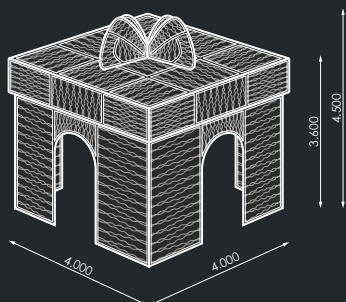
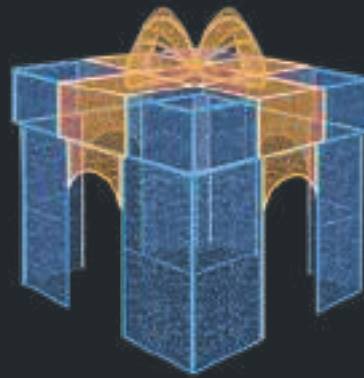

| 565240 | 4x4x4,5m | STRING PLUS          | RGB (LAZO WW)  | 24V | 800W | 340kg |
|--------|----------|----------------------|----------------|-----|------|-------|
| 565226 | 4x4x4,5m | STRING PLUS FLASHING | BLUE (LAZO WW) | 24V | 720W | 320kg |

[GRÁFICOS: Unidades en mm/ GRAPHICS: Units in mm/ GRAPHIQUES: Units en mm/ GRÁFICOS: Unidades em mm]

# Giant Ball

6m



MADE IN SPAIN  
Desing by PRILUX

Motivo  
Motifs  
Motifs  
Motivos

3D



PIXELMAX



| Barcode | Size | String          | LED Type | LED Type        | Voltage | Power (W) | Weight (kg) |
|---------|------|-----------------|----------|-----------------|---------|-----------|-------------|
| 600293  | 6m   | STRING PIXELMAX | flexiLED | LED             | 12V/24V | 5.700W    | 480kg       |
| 600309  | 6m   | STRING PLUS     | flexiLED | STRING PLUS LED | 24V     | 1.110W    | 450kg       |
| 600316  | 6m   | STRING PLUS     | flexiLED | STRING PLUS LED | 24V     | 930W      | 450kg       |

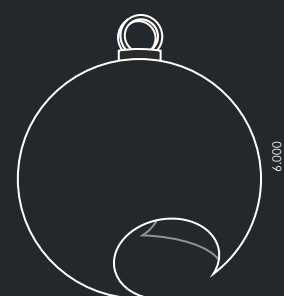



MADE IN SPAIN  
Desing by PRILUX

# Giant Ball Stars

3D Motivo  
Motifs  
Motifs  
Motivos



C.C. The Outlet Store  
Alicante



[GRÁFICOS: Unidades en mm/ GRAPHICS: Units in mm/ GRÁFICOS: Unidades en mm/ GRAPHICS: Units in mm/ GRÁFICOS: Unidades en mm]

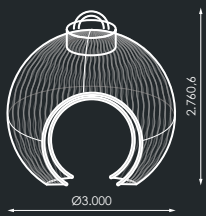

|        |          |                      |           |                 |     |      | <b>W</b> |  |
|--------|----------|----------------------|-----------|-----------------|-----|------|----------|--|
| 567527 | 2,8x2,6m | STRING PLUS FLASHING | flexi LED | STRING PLUS LED | 24V | 210W | 105kg    |  |
| 567541 | 2,8x2,6m | STRING PLUS FLASHING | flexi LED | STRING PLUS LED | 24V | 210W | 105kg    |  |

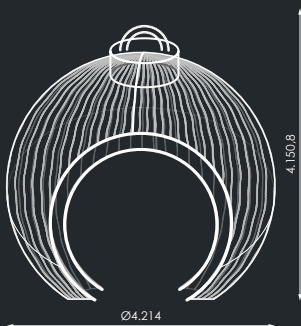

|        |        |                      |           |                 |     |      | <b>W</b> |  |
|--------|--------|----------------------|-----------|-----------------|-----|------|----------|--|
| 567510 | 4,3x4m | STRING PLUS FLASHING | flexi LED | STRING PLUS LED | 24V | 375W | 178kg    |  |
| 567534 | 4,3x4m | STRING PLUS FLASHING | flexi LED | STRING PLUS LED | 24V | 375W | 178kg    |  |



# Giant Ball

## PIXELMAX



MADE IN SPAIN  
Desing by PRILUX

Motivo  
Motifs  
Motifs  
Motivos

3D



Arucas  
Gran Canarias



|        |          |                    |          |     |         |        |       |
|--------|----------|--------------------|----------|-----|---------|--------|-------|
|        |          |                    |          |     |         |        |       |
| 567503 | 2,8x2,6m | STRING<br>PIXELMAX | flexiLED | LED | 12V/24V | 1.570W | 127kg |



|        |        |                    |          |     |         |        |       |
|--------|--------|--------------------|----------|-----|---------|--------|-------|
|        |        |                    |          |     |         |        |       |
| 567497 | 4,3x4m | STRING<br>PIXELMAX | flexiLED | LED | 12V/24V | 2.700W | 196kg |

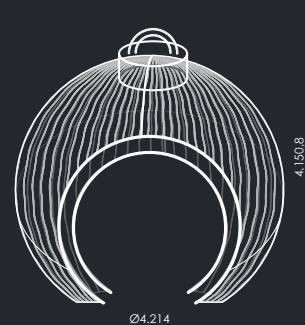





Castelldefels  
Barcelona





# Pingüino Doble 3D

## Selfie



MADE IN SPAIN  
Desing by PRILUX

Motivo  
Motifs  
Motifs  
Motivos

3D

N

NEW



|        |     | 1                           |                   |      | 2                         |
|--------|-----|-----------------------------|-------------------|------|---------------------------|
| 633208 |     | STRING PLUS LED LED LED LED | TAPIZ             |      | RED WHITE ORANGE          |
|        |     | STRING PLUS LED LED LED LED | TAPIZ             |      | RED BLUE RED WHITE ORANGE |
| W      | ⚡   | ⚡                           | ⚡                 | ⚡    | ⚡                         |
| 144W   | 24V | CIII                        | IP65<br>IP44 Plug | 56kg | INC.                      |

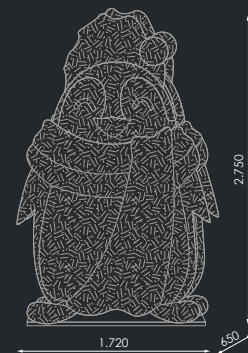

### Aviso/Warning/Avertissement/Aviso

**Ñ/** El SELFIE PINGÜINO DOBLE por una cara es el pingüino rojo y por la otra cara es el pingüino rosa.

**E/** The SELFIE PINGÜINO DOBLE is the red penguin on one side and the pink penguin on the other side.

**F/** Le SELFIE PINGÜINO DOBLE est le pingouin rouge d'un côté et le pingouin rose de l'autre.

**P/** O SELFIE PINGÜINO DOBLE é o pinguin vermelho de um lado e o pinguin cor-de-rosa do outro.



MADE IN SPAIN  
Desing by PRILUX

# Corazones

## Selfie



**N**  
NEW

**3D**  
Motivo  
Motifs  
Motifs  
Motivos

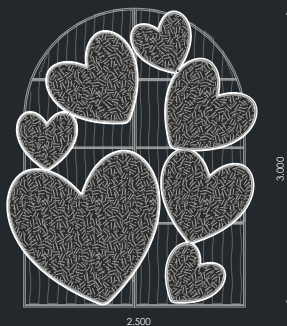
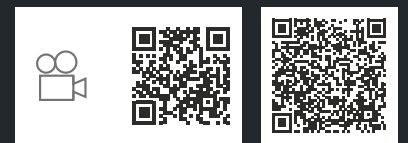

|          |         |                   |                   |        |             |
|----------|---------|-------------------|-------------------|--------|-------------|
|          |         |                   |                   |        |             |
| 624435   | Fijo    | flexi DOUBLE NEON | STRING PLUS       | TAPIZ  | STRING PLUS |
| 624558   | Dynamic | flexi DOUBLE NEON | STRING PLUS       | TAPIZ  | STRING PLUS |
| <b>W</b> |         |                   |                   |        |             |
| 198,7W   | 24V     | CIII              | IP65<br>IP44 Plug | 34,1kg | INC.        |

### Información/Information/Information/Informações

**Ñ/** En el modelo **DYNAMIC**, controlador con varios modos pre-programados para cambiar de efectos.

**E/** On the **DYNAMIC** model, controller with various pre-programmed modes for switching effects.

**F/** Sur le modèle **DYNAMIC**, contrôleur avec différents modes préprogrammés pour les effets de commutation.

**P/** No modelo **DYNAMIC**, controlador com vários modos pré-programados para efeitos de comutação.

[GRÁFICOS: Unidades en mm/ GRAPHICS: Units in mm/ GRÁFICOS: Unidades en mm/ GRÁFICOS: Unidades en mm]

# Mi Mejor Regalo

## Selfie



MADE IN SPAIN  
Desing by PRILUX

Motivo  
Motifs  
Motifs  
Motivos

3D

N

NEW



|        |       |                   |                   |        |             |
|--------|-------|-------------------|-------------------|--------|-------------|
|        | 1     | 2                 | 1                 | 2      |             |
| 635523 | flexi | flexi DOUBLE NEON | STRING PLUS       | TAPIZ  | STRING PLUS |
| W      |       |                   |                   |        |             |
| 213W   | 24V   | CIII              | IP65<br>IP44 Plug | 44,2kg | INC.        |

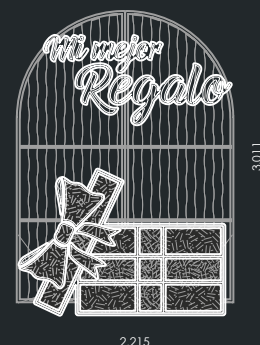





MADE IN SPAIN  
Desing by PRILUX

# Jengibre Selfie

3D Motivo  
Motifs  
Motifs  
Motivos



CC La Gavia  
Madrid



3.011

2.215

|        |       |      |                   |        |
|--------|-------|------|-------------------|--------|
|        |       |      |                   |        |
| 600408 | flexi |      | TAPIZ             | STRING |
|        |       |      |                   |        |
| 140W   | 24V   | CIII | IP65<br>IP44 Plug | 46kg   |
|        |       |      |                   | INC.   |

[GRÁFICOS: Unidades en mm/ GRAPHICS: Units in mm/ GRAPHIQUES: Unités en mm/ GRÁFICOS: Unidades em mm]

# Trono Real

## Selfie



MADE IN SPAIN  
Desing by PRILUX

Motivo  
Motifs  
Motifs  
Motivos

3D



|        |                 |       |                        |      |      |
|--------|-----------------|-------|------------------------|------|------|
|        |                 |       |                        |      |      |
| 600392 | <b>flexiLED</b> | TAPIZ | STRING <b>PLUS LED</b> |      |      |
|        |                 |       |                        |      |      |
| 160W   | 24V             | CIII  | IP65<br>IP44 Plug      | 59kg | INC. |







MADE IN SPAIN  
Desing by PRILUX

# Penguin Selfie

3D  
Motivo  
Motifs  
Motifs  
Motivos



CC Bouevard Vitoria  
Vitoria

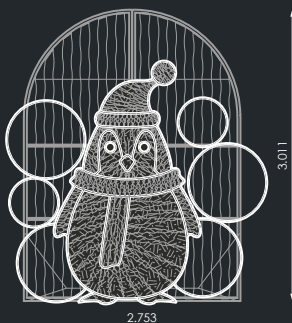

|        |               |                 |                   |                 |
|--------|---------------|-----------------|-------------------|-----------------|
|        |               |                 |                   |                 |
| 562638 | flexi LED LED | STRING PLUS LED | TAPIZ             | STRING PLUS LED |
| W      |               |                 |                   |                 |
| 160W   | 24V           | CIII            | IP65<br>IP44 Plug | 44kg            |
|        |               |                 |                   | INC.            |

[GRÁFICOS: Unidades en mm/ GRAPHICS: Units in mm/ GRAPHIQUES: Unités en mm/ GRÁFICOS: Unidades em mm]

# Alas Tinkerbell

## Selfie



MADE IN SPAIN  
Desing by PRILUX

Motivo  
Motifs  
Motifs  
Motivos

3D



C.C. Gran Via de Vigo  
Vigo



|          |                  |                    |                   |                               |      |
|----------|------------------|--------------------|-------------------|-------------------------------|------|
|          |                  | <b>1</b>           | <b>2</b>          |                               |      |
| 561334   | flexi <b>LED</b> | STRING <b>PLUS</b> | TAPIZ             | STRING <b>PLUS</b> <b>LED</b> |      |
| <b>W</b> |                  |                    |                   |                               |      |
| 125W     | 24V              | CIII               | IP65<br>IP44 Plug | 40kg                          | INC. |







MADE IN SPAIN  
Desing by PRILUX

# Alas Ángel Selfie



3D Motivo  
Motifs  
Motifs  
Motivos

Santa Brígida  
Gran Canarias

[GRÁFICOS: Unidades en mm/ GRAPHICS: Units in mm/ GRAPHIQUES: Unités en mm/ GRÁFICOS: Unidades em mm]

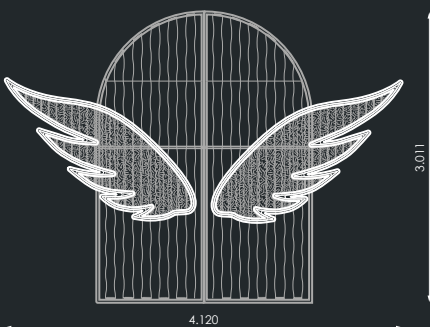

|          |                 |                    |                   |                    |
|----------|-----------------|--------------------|-------------------|--------------------|
|          |                 | <b>1</b>           | <b>2</b>          |                    |
| 562089   | <b>flexiLED</b> | STRING <b>PLUS</b> | TAPIZ             | STRING <b>PLUS</b> |
| <b>W</b> |                 |                    |                   |                    |
| 135W     | 24V             | CIII               | IP65<br>IP44 Plug | 42kg               |
|          |                 |                    |                   | INC.               |

# Caja Regalo Sorpresa Selfie



MADE IN SPAIN  
Desing by PRILUX

Motivo  
Motifs  
Motifs  
Motivos

3D



C.C. Outlet La Torre  
Zaragoza

|          |                    |          |                   |      |      |
|----------|--------------------|----------|-------------------|------|------|
|          | <b>1</b>           | <b>2</b> |                   |      |      |
| 600330   | STRING <b>PLUS</b> | TAPIZ    |                   |      |      |
| <b>W</b> |                    |          |                   |      |      |
| 128W     | 24V                | CIII     | IP65<br>IP44 Plug | 50kg | INC. |

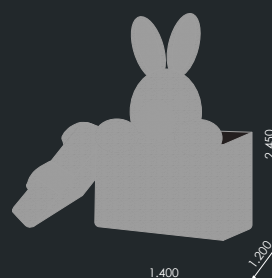



# Ball 3D

## Selfie

**N**  
NEW

**3D**  
Motivo  
Motifs  
Motifs  
Motivos



[GRÁFICOS: Unidades en mm/ GRÁFICOS: Units in mm/GRAPHIQUES: Unités en mm/GRÁFICOS: Unidades em mm]

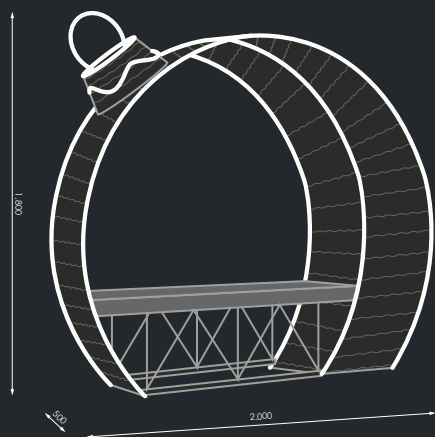

|          |          |                   |         |
|----------|----------|-------------------|---------|
|          |          |                   |         |
| 632089   | flexiLED | STRING PLUS       | PVC NET |
| <b>W</b> |          |                   |         |
| 145W     | 24V      | CIII              | 58kg    |
|          |          |                   |         |
|          |          | IP65<br>IP44 Plug | INC.    |

Información/Information/Information/Informações

**Ñ**/ Estructura dorada.

**E**/ Gold-plated structure.

**F**/ Structure plaquée or.

**P**/ Estrutura banhada a ouro.

# Bota Papá Noel

Selfie



MADE IN SPAIN  
Desing by PRILUX

Motivo  
Motifs  
Motifs  
Motivos

3D



Arucas  
Gran Canarias



|        |       |             |                   |      |       |
|--------|-------|-------------|-------------------|------|-------|
|        |       |             |                   |      |       |
| 600323 | flexi | STRING PLUS |                   |      | TAPIZ |
| W      |       |             |                   |      |       |
| 164W   | 24V   | CIII        | IP65<br>IP44 Plug | 70kg | INC.  |

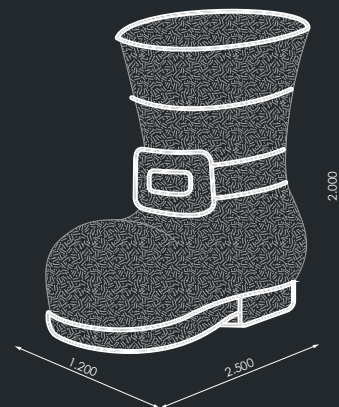

|        |       |             |                   |       |       |
|--------|-------|-------------|-------------------|-------|-------|
|        |       |             |                   |       |       |
| 576895 | flexi | STRING PLUS |                   |       | TAPIZ |
| W      |       |             |                   |       |       |
| 690W   | 24V   | CIII        | IP65<br>IP44 Plug | 150kg | INC.  |

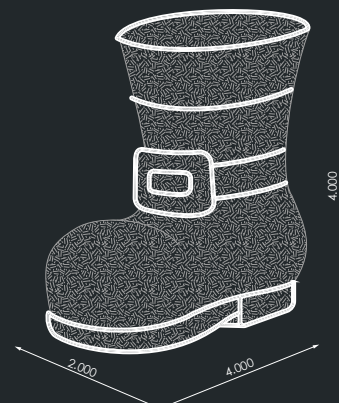





MADE IN SPAIN  
Desing by PRILUX

Oso  
Selfie



3D Motivo  
Motifs  
Motifs  
Motivos

C.C. Outlet La Torre  
Zaragoza

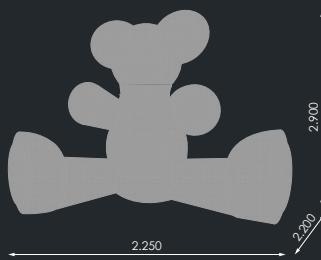

|        |       |             |                   |
|--------|-------|-------------|-------------------|
|        |       | <b>1</b>    | <b>2</b>          |
| 600347 | flexi | STRING PLUS | TAPIZ             |
| W      |       |             |                   |
| 145W   | 24V   | CIII        | IP65<br>IP44 Plug |
|        |       |             | 90kg              |
|        |       |             | INC.              |

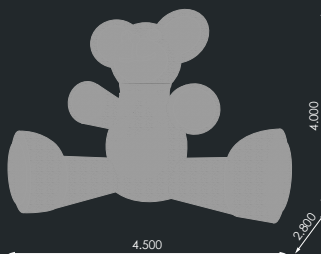

|        |       |             |                   |
|--------|-------|-------------|-------------------|
|        |       | <b>1</b>    | <b>2</b>          |
| 600354 | flexi | STRING PLUS | TAPIZ             |
| W      |       |             |                   |
| 350W   | 24V   | CIII        | IP65<br>IP44 Plug |
|        |       |             | 180kg             |
|        |       |             | INC.              |

[GRÁFICOS: Unidades en mm/ GRAPHICS: Units in mm/ GRAPHIQUES: Unités en mm/ GRÁFICOS: Unidades en mm]

# Trineo 3D



MADE IN SPAIN  
Desing by PRILUX

Motivo  
Motifs  
Motifs  
Motivos

3D

N

NEW

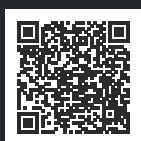

|        | 1               | 2                 | 3                 |
|--------|-----------------|-------------------|-------------------|
| 600378 | flexi LED       | STRING PLUS LED   | TAPIZ flexi LED   |
|        | STRING PLUS LED | PVC NET flexi LED |                   |
| W      | ⚡               | ⚡                 | ⚡                 |
| 60W    | 24V             | CIII              | IP65<br>IP44 Plug |
|        |                 |                   | 40kg              |
|        |                 |                   | INC.              |

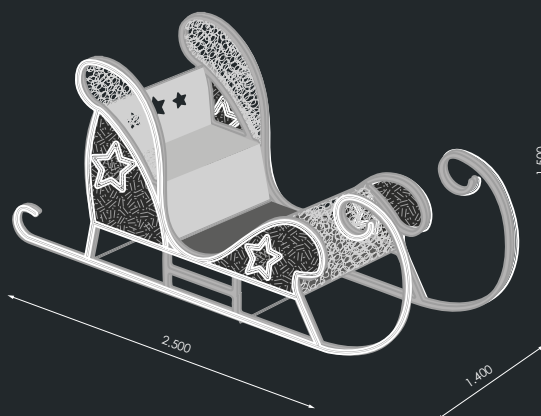

## Información/Information/Information/Informações

Ñ/ Estructura dorada.

E/ Gold-plated structure.

F/ Structure plaquée or.

P/ Estrutura banhada a ouro.



MADE IN SPAIN  
Desing by PRILUX

# Photocall Hexagonal

3D Motivo  
Motifs  
Motifs  
Motivos



[GRÁFICOS: Unidades en mm/ GRAPHICS: Units in mm/ GRAPHIQUES: Unités en mm/ GRÁFICOS: Unidades em mm]

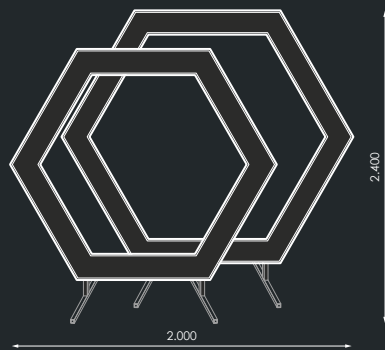

|        |          |                 |                   |      |      |
|--------|----------|-----------------|-------------------|------|------|
|        |          |                 |                   |      |      |
| 600361 | flexiLED | STRING PLUS LED |                   |      |      |
| W      |          |                 |                   |      |      |
| 42W    | 24V      | CIII            | IP65<br>IP44 Plug | 25kg | INC. |

Aviso/Warning/Avertissement/Aviso

Ñ/ Se suministra sin flores.

E/ Supplied without flowers.

F/ Livré sans fleurs.

P/ Fornecido sem flores.

# Campana Transitable



MADE IN SPAIN  
Desing by PRILUX

Motivo  
Motifs  
Motifs  
Motivos

3D



|        |           |             |                   |       |      |
|--------|-----------|-------------|-------------------|-------|------|
|        |           |             |                   |       |      |
| 600248 | flexi LED | STRING PLUS | LED               |       |      |
|        |           |             |                   |       |      |
| 515W   | 24V       | CIII        | IP65<br>IP44 Plug | 200kg | INC. |

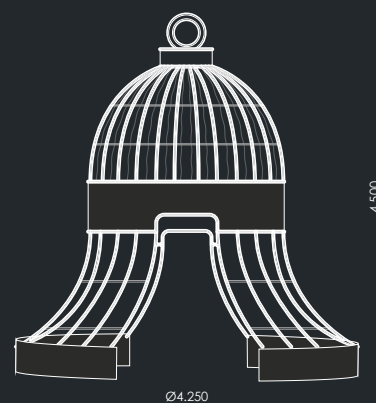

## Información/Information/Information/Informações

Ñ/ Estructura dorada.

E/ Gold-plated structure.

F/ Structure plaquée or.

P/ Estrutura banhada a ouro.

## Bajo pedido / On request / Sur commande / A pedido

Ñ/ Posibilidad de personalización de vinilo bajo proyecto.

E/ Possibility of customization of vinyl under project.

F/ Possibilité de personnalisation du vinyle sous projet.

P/ Possibilidade de customização de vinil sob projeto.





MADE IN SPAIN  
Desing by PRILUX

# Corona Reyes Magos con Control

**N**  
NEW

**3D**  
Motivo  
Motifs  
Motifs  
Motivos

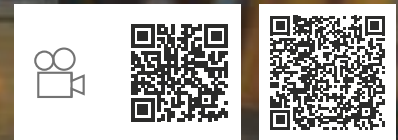

[GRÁFICOS: Unidades en mm/ GRAPHICS: Units in mm/ GRAPHIQUES: Unités en mm/ GRÁFICOS: Unidades em mm]

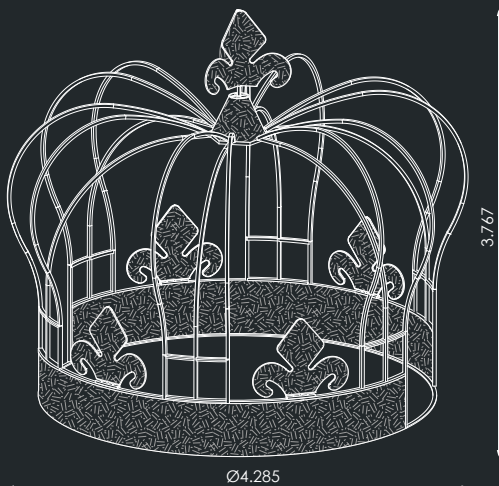

|          |           |             |                   |          |                 |
|----------|-----------|-------------|-------------------|----------|-----------------|
|          |           | <b>1</b>    | <b>2</b>          | <b>3</b> |                 |
| 634267   | flexi LED | STRING PLUS | LED               | PVC NET  | STRING PLUS LED |
| <b>W</b> |           |             |                   |          |                 |
| 250W     | 24V       | CIII        | IP65<br>IP44 Plug | 160kg    | INC.            |

Información/Information/Information/Informações

**Ñ**/ Estructura dorada.

**E**/ Gold-plated structure.

**F**/ Structure plaquée or.

**P**/ Estrutura banhada a ouro.

# Photocall Elf



MADE IN SPAIN  
Desing by PRILUX

Motivo  
Motifs  
Motifs  
Motivos

3D



Gavá  
Barcelona

|        |                            |       |                   |       |      |
|--------|----------------------------|-------|-------------------|-------|------|
|        |                            |       |                   |       |      |
| 512206 | flexiLED                   | TAPIZ |                   |       |      |
|        |                            |       |                   |       |      |
| 361W   | 24V (XMAS)<br>230V (Resto) | CII   | IP65<br>IP44 Plug | 125kg | INC. |







MADE IN SPAIN  
Desing by PRILUX

# Photocall Reindeer

3D  
Motivo  
Motifs  
Motivos



C.C. Nueva Condomina  
Churra, Murcia

[GRÁFICOS: Unidades en mm/ GRAPHICS: Units in mm/ GRAPHIQUES: Unités en mm/ GRÁFICOS: Unidades em mm]



|        |                            |       |                   |       |      |
|--------|----------------------------|-------|-------------------|-------|------|
|        |                            |       |                   |       |      |
| 512213 | flexi                      | TAPIZ |                   |       |      |
| W      |                            |       |                   |       |      |
| 342W   | 24V (XMAS)<br>230V (Resto) | CII   | IP65<br>IP44 Plug | 125kg | INC. |

# Photocall Xmas Doble 3D



MADE IN SPAIN  
Desing by PRILUX

Motivo  
Motifs  
Motifs  
Motivos

3D

N

NEW



|               |     |       |                   |      |      |
|---------------|-----|-------|-------------------|------|------|
| flexi LED LED |     | TAPIZ |                   |      |      |
| 633260        |     |       |                   |      |      |
| flexi LED LED |     | TAPIZ |                   |      |      |
| W             | ⚡   | ⬠     | ⊕                 | ⚖    | ⌚    |
| 348W          | 24V | CIII  | IP65<br>IP44 Plug | 90kg | INC. |



## Aviso/Warning/Avertissement/Aviso

**Ñ/** El PHOTOCALL XMAS por una cara es dorado y por la otra cara es verde y azul

**E/** The PHOTOCALL XMAS is gold on one side and green and blue on the other side.

**F/** Le PHOTOCALL XMAS est doré d'un côté et vert et bleu de l'autre.

**P/** O PHOTOCALL XMAS é dourado de um lado e verde e azul do outro.





MADE IN SPAIN  
Desing by PRILUX

# Corazón

## Portal

3D

Motivo  
Motifs  
Motifs  
Motivos

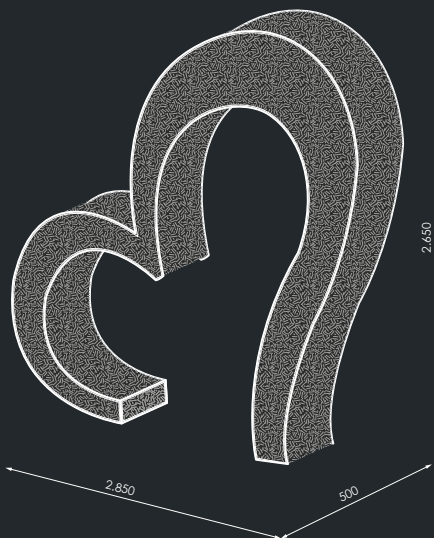

|        |           |                 |                   |      |      |
|--------|-----------|-----------------|-------------------|------|------|
|        |           |                 |                   |      |      |
| 600262 | flexi LED | STRING PLUS LED | PVC NET           |      |      |
| W      |           |                 |                   |      |      |
| 144W   | 24V       | CIII            | IP65<br>IP44 Plug | 70kg | INC. |

Bajo pedido / On request / Sur commande / A pedido

Ñ/ Posibilidad utilizar tapiz en lugar de PVC NET.

E/ Possibility to use tapestry instead of PVC NET.

F/ Possibilité d'utiliser du tapisserie à la place de la PVC NET.

P/ Possibilidade de usar tapetaria em vez de PVC NET.

[GRÁFICOS: Unidades en mm/ GRAPHICS: Units in mm/ GRAPHIQUES: Unités en mm/ GRÁFICOS: Unidades em mm]

# Photocall

## Portal



MADE IN SPAIN  
Desing by PRILUX

Motivo  
Motifs  
Motifs  
Motivos

3D



Guadalupe  
Cáceres



CC. Lagoh  
Sevilla

|        |          | 1     | 2  |
|--------|----------|-------|--|
| 511315 | flexiLED | TAPIZ | STRING LED   |
| 511322 | flexiLED | TAPIZ | STRING LED   |
| W      | ⚡        | ⬠     | ⬠  |
| 726W   | 24V      | CIII  | IP65<br>IP44 Plug  |
|        |          | 220kg | (2x) 205x55x55cm<br>(2x) 180x105x55cm<br>(2x) 175x155x10cm |
|        |          |       | INC.   |

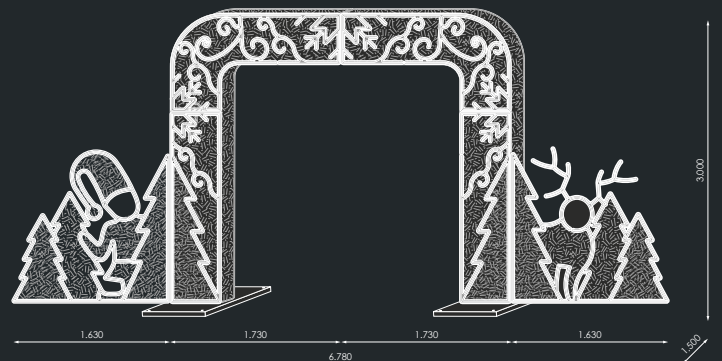





MADE IN SPAIN  
Desing by PRILUX

# Star Portal

3D Motivo  
Motifs  
Motifs  
Motivos



[GRÁFICOS: Unidades en mm/ GRAPHICS: Units in mm/ GRAPHIQUES: Unités en mm/ GRÁFICOS: Unidades em mm]

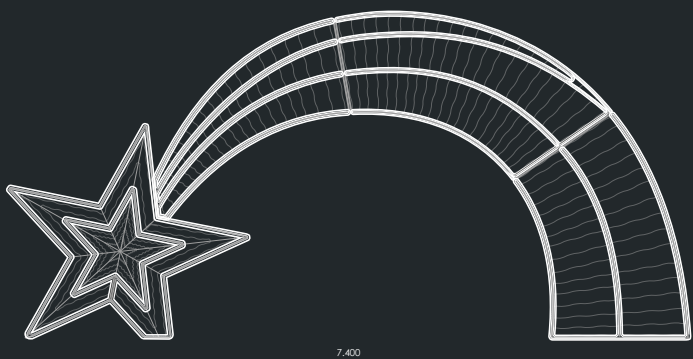

|        |           |                     |                   |       |      |
|--------|-----------|---------------------|-------------------|-------|------|
|        |           | 1                   | 2                 |       |      |
| 600255 | flexi LED | STRING PLUS LED LED | PVC NET           |       |      |
| W      |           |                     |                   |       |      |
| 760W   | 24V       | CIII                | IP65<br>IP44 Plug | 260kg | INC. |

# Bear Portal



MADE IN SPAIN  
Desing by PRILUX

Motivo  
Motifs  
Motifs  
Motivos

3D



CC. Maremagnum  
Barcelona

|        |           |                     |                   |       |      |
|--------|-----------|---------------------|-------------------|-------|------|
|        |           |                     |                   |       |      |
| 567558 | flexi LED | STRING PLUS LED LED | PVC NET           |       |      |
| W      |           |                     |                   |       |      |
| 804,6W | 24V       | CIII                | IP65<br>IP44 Plug | 300kg | INC. |

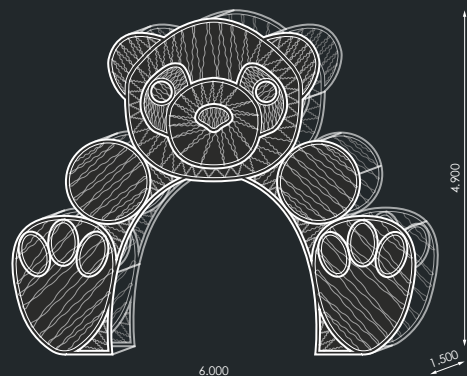





MADE IN SPAIN  
Desing by PRILUX

# Papá Noel Portal

**N**  
NEW

**3D**  
Motivo  
Motifs  
Motifs  
Motivos



[GRÁFICOS: Unidades en mm/ GRAPHICS: Units in mm/GRAPHIQUES: Unités en mm/GRÁFICOS: Unidades em mm]

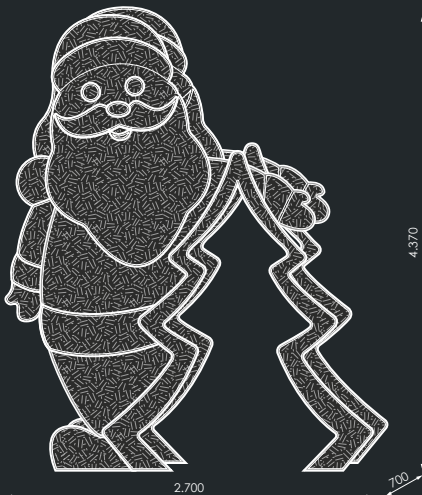

|          |                 |                    |  |       |      |
|----------|-----------------|--------------------|--|-------|------|
|          |                 | <b>1</b>           | <b>2</b>                               |       |      |
| 633277   | <b>flexiLED</b> | STRING <b>PLUS</b> | <b>LED</b> <b>LED</b> <b>LED</b> TAPIZ |       |      |
| <b>W</b> |                 |                    |  |       |      |
| 493W     | 24V             | CIII               | IP65<br>IP44 Plug                      | 130kg | INC. |

# Xmas Portal



MADE IN SPAIN  
Desing by PRILUX

Motivo  
Motifs  
Motifs  
Motivos

3D



Camargo  
Santander

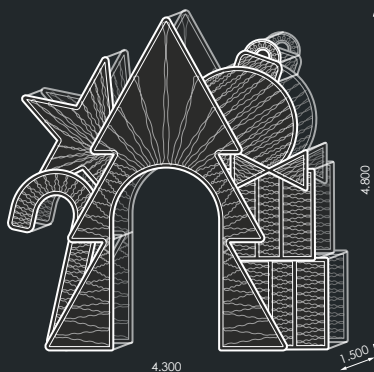

|        |           |                         |                   |       |      |
|--------|-----------|-------------------------|-------------------|-------|------|
|        |           |                         |                   |       |      |
| 567572 | flexi LED | STRING PLUS LED LED LED | PVC NET           |       |      |
|        |           |                         |                   |       |      |
| 550W   | 24V       | CIII                    | IP65<br>IP44 Plug | 210kg | INC. |





MADE IN SPAIN  
Desing by PRILUX

# Tunel Transitable

3D Motivo  
Motifs  
Motifs  
Motivos



Arucas  
Canarias

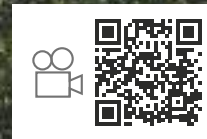

[GRÁFICOS: Unidades en mm/ GRAPHICS: Units in mm/ GRAPHIQUES: Unités en mm/ GRÁFICOS: Unidades em mm]

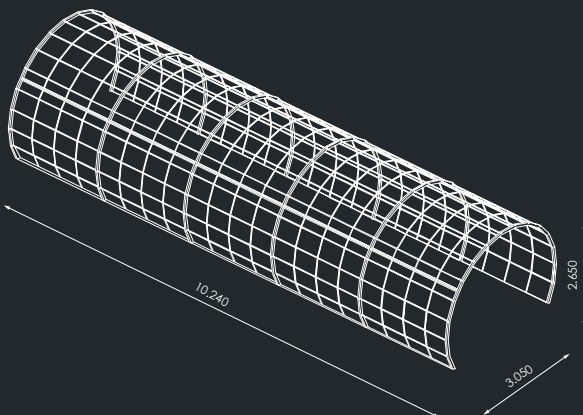

| 511247 | 3,14x2,80x10,24m | STRING<br>PIXELMAX<br>RGB | 12V | 4.980W | 350kg |
|--------|------------------|---------------------------|-----|--------|-------|

# Globo Ayika



MADE IN SPAIN  
Desing by PRILUX

Motivo  
Motifs  
Motifs  
Motivos

3D

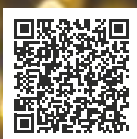

Santa Brígida  
Gran Canarias

|        |           | 1               | 2                 |      |      |
|--------|-----------|-----------------|-------------------|------|------|
| 567589 | flexi LED | STRING PLUS LED | TAPIZ             |      |      |
| 567596 | flexi LED | STRING PLUS LED | TAPIZ             |      |      |
| W      | ⚡         | □               | ⊙                 | ⚖    | ⌚    |
| 140W   | 230V      | CII             | IP65<br>IP44 Plug | 32kg | INC. |

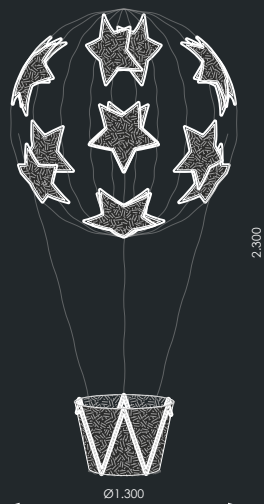





MADE IN SPAIN  
Desing by PRILUX

# Globo Bahín Maxibrillo



3D  
Motivo  
Motifs  
Motivos

Arucas  
Canarias



[GRÁFICOS: Unidades en mm/ GRAPHICS: Units in mm/GRÁFICOS: Unidades en mm/GRÁFICOS: Unidades en mm]

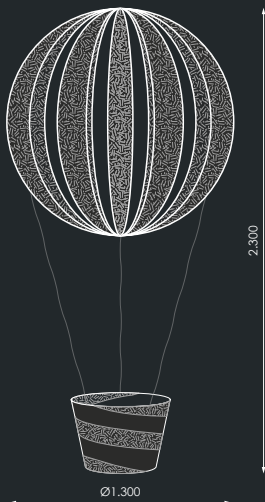

|        |          | 1               | 2                 |
|--------|----------|-----------------|-------------------|
|        |          |                 |                   |
| 454643 | flexiLED | STRING PLUS LED | TAPIZ             |
| 459075 | flexiLED | STRING PLUS LED | TAPIZ             |
| W      | ⚡        | □               | ⊙                 |
| 416W   | 230V     | CII             | IP65<br>IP44 Plug |
|        |          |                 | ⚖                 |
|        |          |                 | 30kg              |
|        |          |                 | ⚡                 |
|        |          |                 | INC.              |

Motivo  
Motifs  
Motifs  
Motivos

3D



Guareña  
Cáceres

Ø90cm

|        | 1                         | 2     |
|--------|---------------------------|-------|
| 446310 | flexi LED STRING PLUS LED | TAPIZ |
| 446327 | flexi LED STRING PLUS LED | TAPIZ |
| W      | ⚡                         | □     |
| 73W    | 230V                      | CII   |
|        | IP65<br>IP44 Plug         | 6kg   |
|        | 95x95x65cm                | INC.  |



Ø130cm

|        | 1                         | 2      |
|--------|---------------------------|--------|
| 446358 | flexi LED STRING PLUS LED | TAPIZ  |
| 446365 | flexi LED STRING PLUS LED | TAPIZ  |
| W      | ⚡                         | □      |
| 105W   | 230V                      | CII    |
|        | IP65<br>IP44 Plug         | 12,5kg |
|        | 135x135x85cm              | INC.   |







MADE IN SPAIN  
Desing by PRILUX

# Bahín Maxibrillo

3D  
Motivo  
Motifs  
Motivos



[GRÁFICOS: Unidades en mm/ GRAPHICS: Units in mm/ GRAPHIQUES: Unités en mm/GRÁFICOS: Unidades em mm]

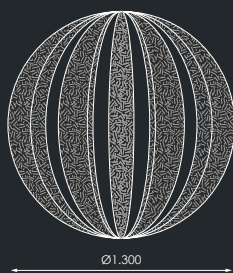
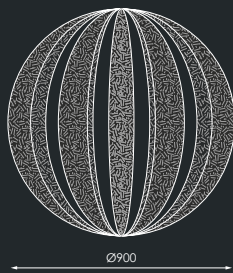

| Ø90cm |        |          |          |           |             |                 |
|-------|--------|----------|----------|-----------|-------------|-----------------|
| Icon  | Code   | LED Type | Material | Power (W) | Voltage (V) | Dimensions (cm) |
|       | 444958 | flexiLED | TAPIZ    | 277W      | 230V        | 95x95x65        |
|       | 444965 | flexiLED | TAPIZ    |           |             |                 |
|       | 444972 | flexiLED | TAPIZ    |           |             |                 |
|       |        |          |          |           |             |                 |
|       |        |          |          |           |             |                 |
|       |        |          |          |           |             |                 |
|       |        |          |          |           |             |                 |
|       |        |          |          |           |             |                 |
|       |        |          |          |           |             |                 |
|       |        |          |          |           |             |                 |

| Ø130cm |        |          |          |           |             |                 |
|--------|--------|----------|----------|-----------|-------------|-----------------|
| Icon   | Code   | LED Type | Material | Power (W) | Voltage (V) | Dimensions (cm) |
|        | 445009 | flexiLED | TAPIZ    | 378W      | 230V        | 135x135x85      |
|        | 445016 | flexiLED | TAPIZ    |           |             |                 |
|        | 445023 | flexiLED | TAPIZ    |           |             |                 |
|        |        |          |          |           |             |                 |
|        |        |          |          |           |             |                 |
|        |        |          |          |           |             |                 |
|        |        |          |          |           |             |                 |
|        |        |          |          |           |             |                 |
|        |        |          |          |           |             |                 |
|        |        |          |          |           |             |                 |

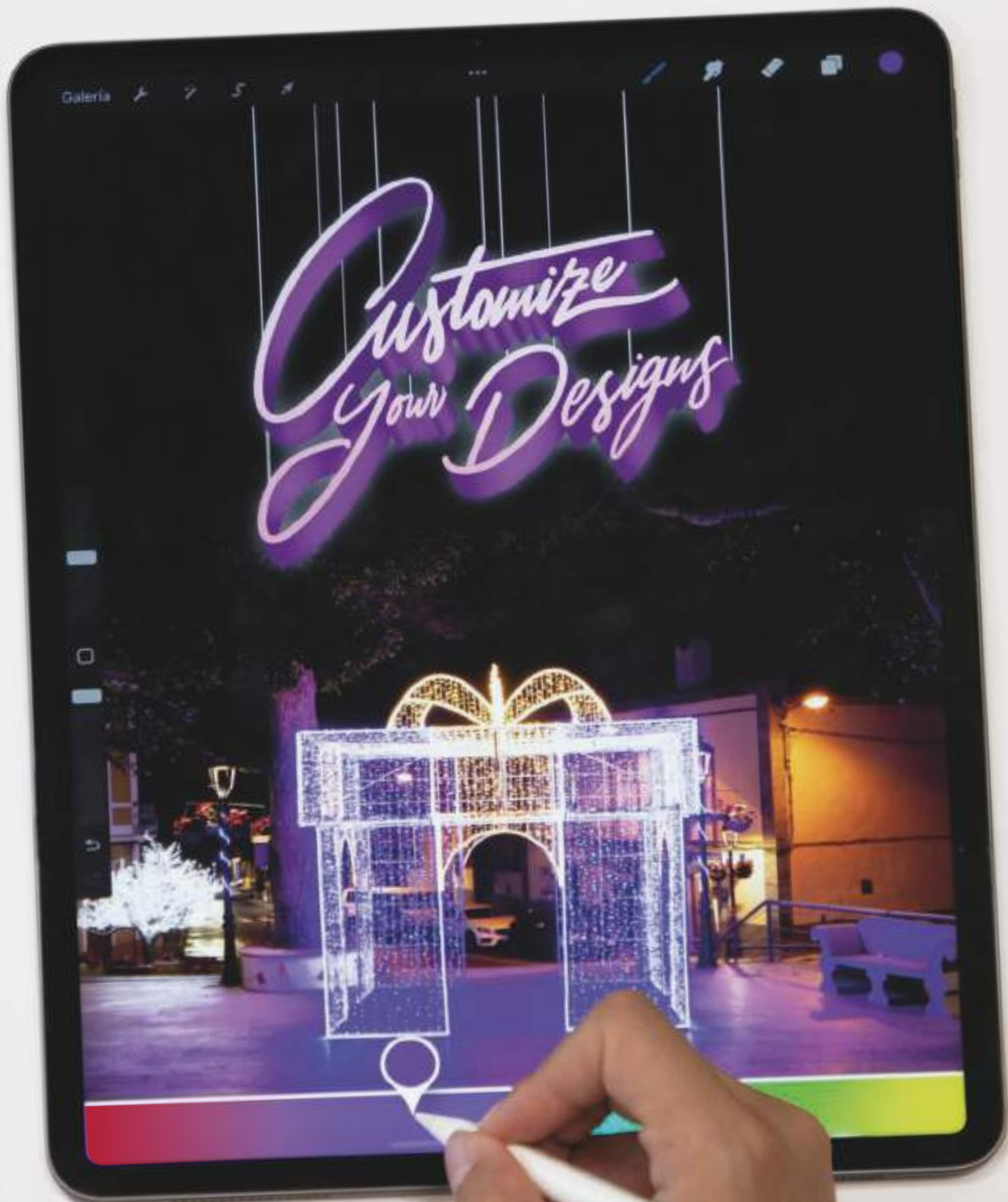

+ info





# Sphere 3D

**3D** Motivo  
Motifs  
Motifs  
Motivos

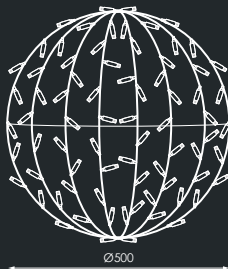

| 597548 | STRING PLUS LED |     |                   |        |            |      |
|--------|-----------------|-----|-------------------|--------|------------|------|
| 597555 | STRING PLUS LED |     |                   |        |            |      |
| 597562 | STRING PLUS LED |     |                   |        |            |      |
| 597579 | STRING PLUS LED |     |                   |        |            |      |
| 597609 | STRING PLUS LED |     |                   |        |            |      |
| 597616 | STRING PLUS LED |     |                   |        |            |      |
| W      | ⚡               | □   | ⊙                 | kg     | ⊞          | ⏏    |
| 13,8W  | 230V            | CII | IP65<br>IP44 Plug | 1,65kg | 52x52x12cm | INC. |

Información / Information / Information / Informações

[GRÁFICOS: Unidades en mm/ GRÁFICOS: Units in mm/ GRAPHIQUES: Unités en mm/ GRÁFICOS: Unidades em mm]

Ñ/ Motivo 3D PLEGABLE

E/ 3D FOLDING motive

F/Motif 3D PLIABLE

P/ Motivo 3D DOBRÁVEL

# Sphere 3D



MADE IN SPAIN  
Desing by PRILUX

Motivo  
Motifs  
Motifs  
Motivos

3D



Galdar  
Las Palmas, Gran Canarias

| Ø90cm      |                 |                   |       |
|------------|-----------------|-------------------|-------|
| Icon       | Icon            | Icon              | W     |
| 445467     | STRING PLUS LED |                   | 26W   |
| 445450     | STRING PLUS LED |                   | 26W   |
| 445528     | STRING PLUS LED |                   | 26W   |
| 445511     | STRING PLUS LED |                   | 26W   |
| 488860     | STRING PLUS LED |                   | 27,6W |
| 510592     | STRING PLUS LED |                   | 27,6W |
| ⚡          | □               | ⊙                 | kg    |
| 230V       | CII             | IP65<br>IP44 Plug | 5kg   |
| 📦          | 🔌               |                   |       |
| 93x93x40cm | INC.            |                   |       |

| Ø130cm       |                 |                   |     |
|--------------|-----------------|-------------------|-----|
| Icon         | Icon            | Icon              | W   |
| 445481       | STRING PLUS LED |                   | 27W |
| 445474       | STRING PLUS LED |                   | 27W |
| 445542       | STRING PLUS LED |                   | 27W |
| 445535       | STRING PLUS LED |                   | 27W |
| 488877       | STRING PLUS LED |                   | 37W |
| 510608       | STRING PLUS LED |                   | 37W |
| ⚡            | □               | ⊙                 | kg  |
| 230V         | CII             | IP65<br>IP44 Plug | 6kg |
| 📦            | 🔌               |                   |     |
| 133x133x50cm | INC.            |                   |     |

| Ø160cm       |                 |                   |       |
|--------------|-----------------|-------------------|-------|
| Icon         | Icon            | Icon              | W     |
| 445504       | STRING PLUS LED |                   | 34W   |
| 445498       | STRING PLUS LED |                   | 34W   |
| 445566       | STRING PLUS LED |                   | 34W   |
| 445559       | STRING PLUS LED |                   | 34W   |
| 488884       | STRING PLUS LED |                   | 46W   |
| 510615       | STRING PLUS LED |                   | 46W   |
| ⚡            | □               | ⊙                 | kg    |
| 230V         | CII             | IP65<br>IP44 Plug | 7,5kg |
| 📦            | 🔌               |                   |       |
| 163x163x60cm | INC.            |                   |       |

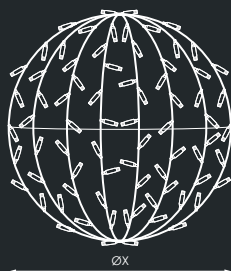

Información / Information / Information / Informações

Ñ/ Motivo 3D PLEGABLE

E/ 3D FOLDING motive

F/Motif 3D PLIABLE

P/ Motivo 3D DOBRÁVEL



MADE IN SPAIN  
Desing by PRILUX

# Bola Mimbre



3D Motivo  
Motifs  
Motifs  
Motivos



Almonte  
Huelva

| Ø30cm  |                    |
|--------|--------------------|
|        |                    |
| 566872 |                    |
| 233521 |                    |
| 144636 |                    |
| 144643 |                    |
| 602228 |                    |
| 602235 |                    |
| 602242 |                    |
| W      |                    |
| 9W     | 230V CII IP44 INC. |

| Ø60cm  |                    |
|--------|--------------------|
|        |                    |
| 469746 |                    |
| 233514 |                    |
| 144704 |                    |
| 144711 |                    |
| 575201 |                    |
| 602259 |                    |
| 602266 |                    |
| W      |                    |
| 28W    | 230V CII IP44 INC. |

| Ø80cm  |                    |
|--------|--------------------|
|        |                    |
| 469739 |                    |
| 160445 |                    |
| 144766 |                    |
| 144773 |                    |
| 144797 |                    |
| 602273 |                    |
| 582438 |                    |
| W      |                    |
| 45W    | 230V CII IP44 INC. |

| Ø100cm |                    |
|--------|--------------------|
|        |                    |
| 520959 |                    |
| 364911 |                    |
| 364935 |                    |
| 365079 |                    |
| 364898 |                    |
| 210812 |                    |
| 210829 |                    |
| W      |                    |
| 67,2W  | 230V CII IP44 INC. |

| Ø120cm |                    |
|--------|--------------------|
|        |                    |
| 566889 |                    |
| 364928 |                    |
| 364942 |                    |
| 210836 |                    |
| 364904 |                    |
| 210843 |                    |
| 210867 |                    |
| W      |                    |
| 96W    | 230V CII IP44 INC. |

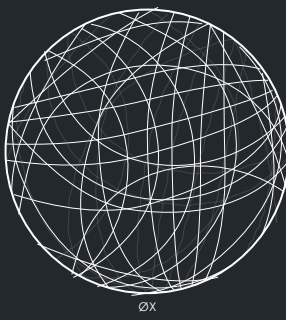

[GRÁFICOS: Unidades en mm/ GRÁFICOS: Units in mm/GRAPHIQUES: Unités en mm/GRÁFICOS: Unidades en mm]





Yaiza  
Lanzarote



MADE IN SPAIN  
Desing by PRILUX

# Mariposa 3D con Movimiento

**N**  
NEW

**3D**  
Motivo  
Motifs  
Motivos



**Arucas**  
Gran Canarias

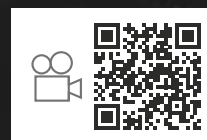

[GRÁFICOS: Unidades en mm/ GRAPHICS: Units in mm/ GRAPHIQUES: Unités en mm/GRÁFICOS: Unidades en mm]



|          |                   |
|----------|-------------------|
|          |                   |
| 615174   | flexi             |
| <b>W</b> |                   |
| 180W     | 230V              |
|          |                   |
| CII      | IP65<br>IP44 Plug |
|          |                   |
| 46kg     | 110x160x70cm      |
|          | INC.              |

# 3D Lamps



MADE IN SPAIN  
Desing by PRILUX

Motivo  
Motifs  
Motifs  
Motivos

3D

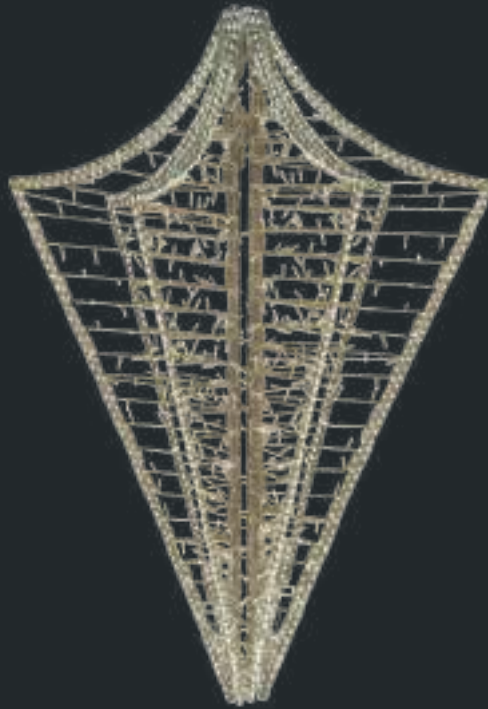

A

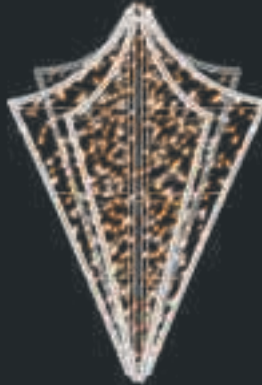

B



C



| Barcode | Color | LED Type  | STRING PLUS LED | W    |
|---------|-------|-----------|-----------------|------|
| 510516  | A     | flexi LED | STRING PLUS LED | 166W |
| 510523  | B     | flexi LED | STRING PLUS LED | 140W |
| 510530  | C     | flexi LED | STRING PLUS LED | 140W |

| Voltage | Control | IP Rating         | Weight | Dimensions       | Finish |
|---------|---------|-------------------|--------|------------------|--------|
| 230V    | CII     | IP65<br>IP44 Plug | 15,5kg | (3x) 210x74x10cm | INC.   |



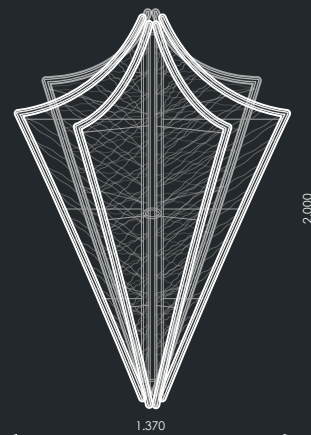



MADE IN SPAIN  
Desing by PRILUX

# 3D Stars

3D Motivo  
Motifs  
Motifs  
Motivos



A



B



C

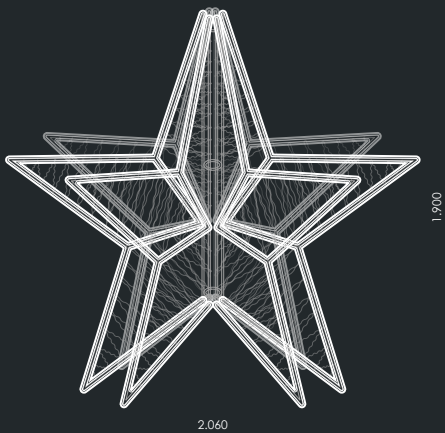

|        |    | 1                        | 2       | W                         |
|--------|----|--------------------------|---------|---------------------------|
| 510486 | A  | flexiLED STRING PLUS LED | PVC NET | 276W                      |
| 510493 | B  | flexiLED STRING PLUS LED | PVC NET | 186W                      |
| 510509 | C  | flexiLED STRING PLUS LED | PVC NET | 186W                      |
| ⚡      | □  | ⦿                        | ⚖       | 📦                         |
| 230V   | CI | IP65<br>IP44 Plug        | 22kg    | (3x) 200x110x10cm<br>INC. |

[GRÁFICOS: Unidades en mm/ GRAPHICS: Units in mm/ GRAPHIQUES: Unités en mm/ GRÁFICOS: Unidades em mm]

# Renos

## 3D Tapiz



MADE IN SPAIN  
Desing by PRILUX

Motivo  
Motifs  
Motifs  
Motivos

3D



|        |           |                 |                   |      |      |
|--------|-----------|-----------------|-------------------|------|------|
|        |           |                 |                   |      |      |
| 563086 | flexi LED | STRING PLUS LED | TAPIZ             |      |      |
| W      |           |                 |                   |      |      |
| 53W    | 24V       | CIII            | IP65<br>IP44 Plug | 35kg | INC. |



|        |           |                 |                   |      |      |
|--------|-----------|-----------------|-------------------|------|------|
|        |           |                 |                   |      |      |
| 563093 | flexi LED | STRING PLUS LED | TAPIZ             |      |      |
| W      |           |                 |                   |      |      |
| 52W    | 24V       | CIII            | IP65<br>IP44 Plug | 30kg | INC. |



|        |           |                 |                   |      |      |
|--------|-----------|-----------------|-------------------|------|------|
|        |           |                 |                   |      |      |
| 563109 | flexi LED | STRING PLUS LED | TAPIZ             |      |      |
| W      |           |                 |                   |      |      |
| 51W    | 24V       | CIII            | IP65<br>IP44 Plug | 34kg | INC. |

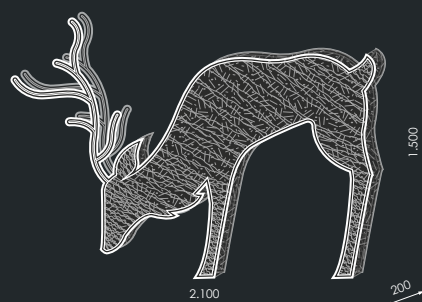





Gavá  
Barcelona



Gavá  
Barcelona



# Reno 3D

Motivo  
Motifs  
Motifs  
Motivos

3D

90cm



120cm



180cm



|        |     |      |
|--------|-----|------|
|        |     |      |
| 563253 | LED | 0,9m |

|      |    |      |      |     |      |
|------|----|------|------|-----|------|
| W    |    |      |      |     |      |
| 3,6W | 3V | CIII | IP44 | 120 | INC. |



|        |     |      |
|--------|-----|------|
|        |     |      |
| 563246 | LED | 1,2m |

|      |    |      |      |     |      |
|------|----|------|------|-----|------|
| W    |    |      |      |     |      |
| 3,6W | 3V | CIII | IP44 | 240 | INC. |



|        |     |      |
|--------|-----|------|
|        |     |      |
| 563284 | LED | 1,8m |

|      |    |      |      |     |      |
|------|----|------|------|-----|------|
| W    |    |      |      |     |      |
| 3,6W | 3V | CIII | IP44 | 360 | INC. |



## Información / Information / Information / Informações

Ñ/ Estructura blanca metálica.

E/ White metal structure.

F/ Structure métallique blanche.

P/ Estructura de metal branco.



MADE IN SPAIN  
Desing by PRILUX

# Vitela Line

**3D** Motivo  
Motifs  
Motifs  
Motivos



[GRÁFICOS: Unidades en mm/ GRAPHICS: Units in mm/ GRÁFICOS: Unidades en mm/ GRAPHICS: Units in mm/ GRÁFICOS: Unidades en mm]



| 3x2m     |                   |      |      |
|----------|-------------------|------|------|
|          |                   |      |      |
| 392631   | Cluster Fall Lite |      |      |
| 392624   | Cluster Fall Lite |      |      |
| <b>W</b> |                   |      |      |
| 17,5W    | 230V              | CII  | IP20 |
|          |                   |      |      |
| 18kg     | 202x50x10cm       | INC. |      |

| 5x2m     |                   |      |      |
|----------|-------------------|------|------|
|          |                   |      |      |
| 392655   | Cluster Fall Lite |      |      |
| <b>W</b> |                   |      |      |
| 30W      | 230V              | CII  | IP20 |
|          |                   |      |      |
| 20,5kg   | 202x50x10cm       | INC. |      |

| 10x2m    |                   |      |      |
|----------|-------------------|------|------|
|          |                   |      |      |
| 392679   | Cluster Fall Lite |      |      |
| 392662   | Cluster Fall Lite |      |      |
| <b>W</b> |                   |      |      |
| 60W      | 230V              | CII  | IP20 |
|          |                   |      |      |
| 26,5kg   | 202x50x10cm       | INC. |      |

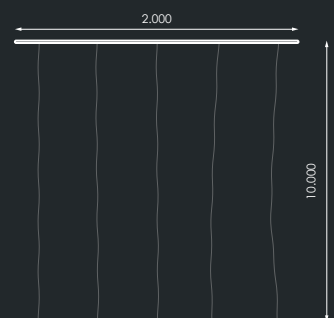
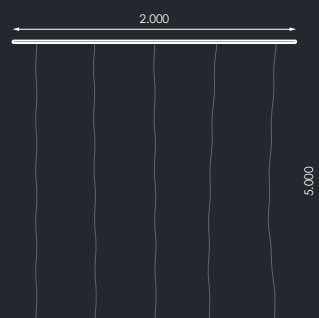
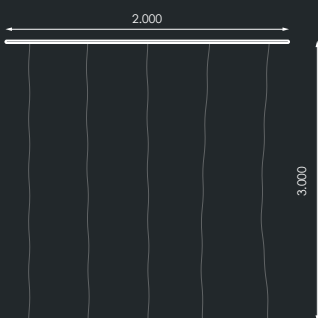

# Nacimiento 3D



MADE IN SPAIN  
Desing by PRILUX

Motivo  
Motifs  
Motifs  
Motivos

3D



Vega de San Mateo  
Gran Canarias



|        |               |                     |                   |      |      |
|--------|---------------|---------------------|-------------------|------|------|
|        |               |                     |                   |      |      |
| 511339 | flexi LED LED | STRING PLUS LED LED | TAPIZ             |      |      |
| W      |               |                     |                   |      |      |
| 198W   | 24V           | CIII                | IP65<br>IP44 Plug | 62kg | INC. |





MADE IN SPAIN  
Desing by PRILUX

# Nacimiento 3D Completo

3D Motivo  
Motifs  
Motifs  
Motivos



Arucas  
Gran Canarias



[GRÁFICOS: Unidades en mm/ GRAPHICS: Units in mm/ GRAPHIQUES: Unités en mm/ GRÁFICOS: Unidades em mm]

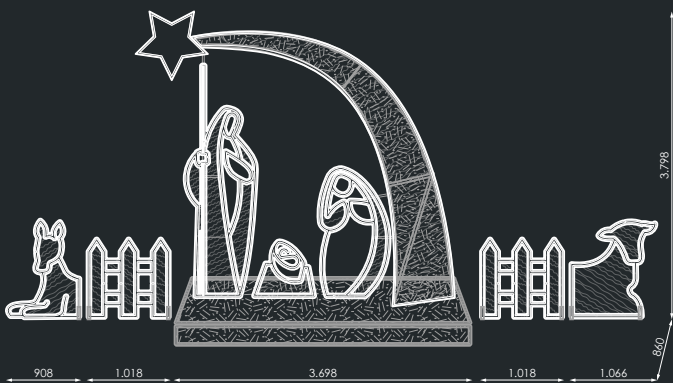

|        |               |                     |                   |      |      |
|--------|---------------|---------------------|-------------------|------|------|
|        |               |                     |                   |      |      |
| 511353 | flexi LED LED | STRING PLUS LED LED | TAPIZ             |      |      |
| W      |               |                     |                   |      |      |
| 302W   | 24V           | CIII                | IP65<br>IP44 Plug | 79kg | INC. |

# Nacimiento

## Pequeño



MADE IN SPAIN  
Desing by PRILUX

Motivo  
Motifs  
Motifs  
Motivos

3D



Canarias

|        |      |
|--------|------|
|        |      |
| 551946 |      |
|        |      |
|        |      |
| 227W   | 230V |
| CII    | IP44 |
| INC.   |      |

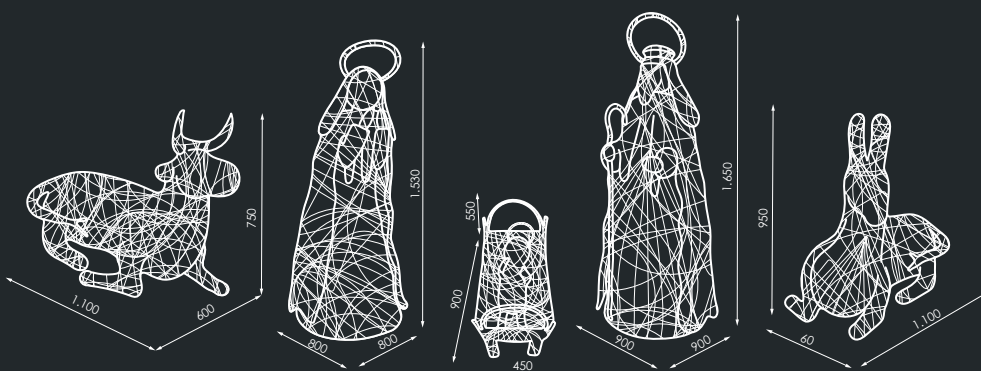





MADE IN SPAIN  
Desing by PRILUX

# Nacimiento

## Grande

3D

Motivo  
Motifs  
Motifs  
Motivos



Pozuelo de Alarcón  
Madrid



[GRÁFICOS: Unidades en mm/ GRAPHICS: Units in mm/ GRAPHIQUES: Unités en mm/ GRÁFICOS: Unidades em mm]

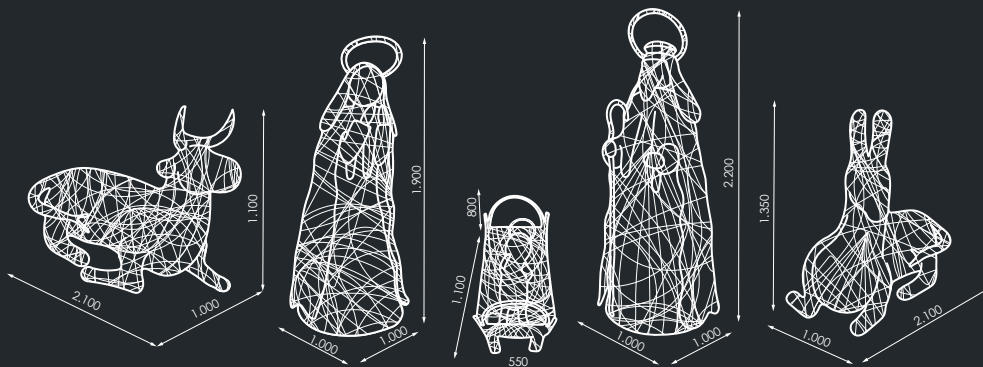

|        |      |
|--------|------|
|        |      |
| 365239 |      |
|        |      |
|        |      |
| 350W   | 230V |
| CII    | IP44 |
| INC.   |      |





# Sistemas dinámicos

Dynamic systems

Systèmes dynamiques

Sistemas dinâmicos

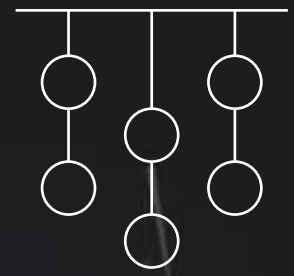







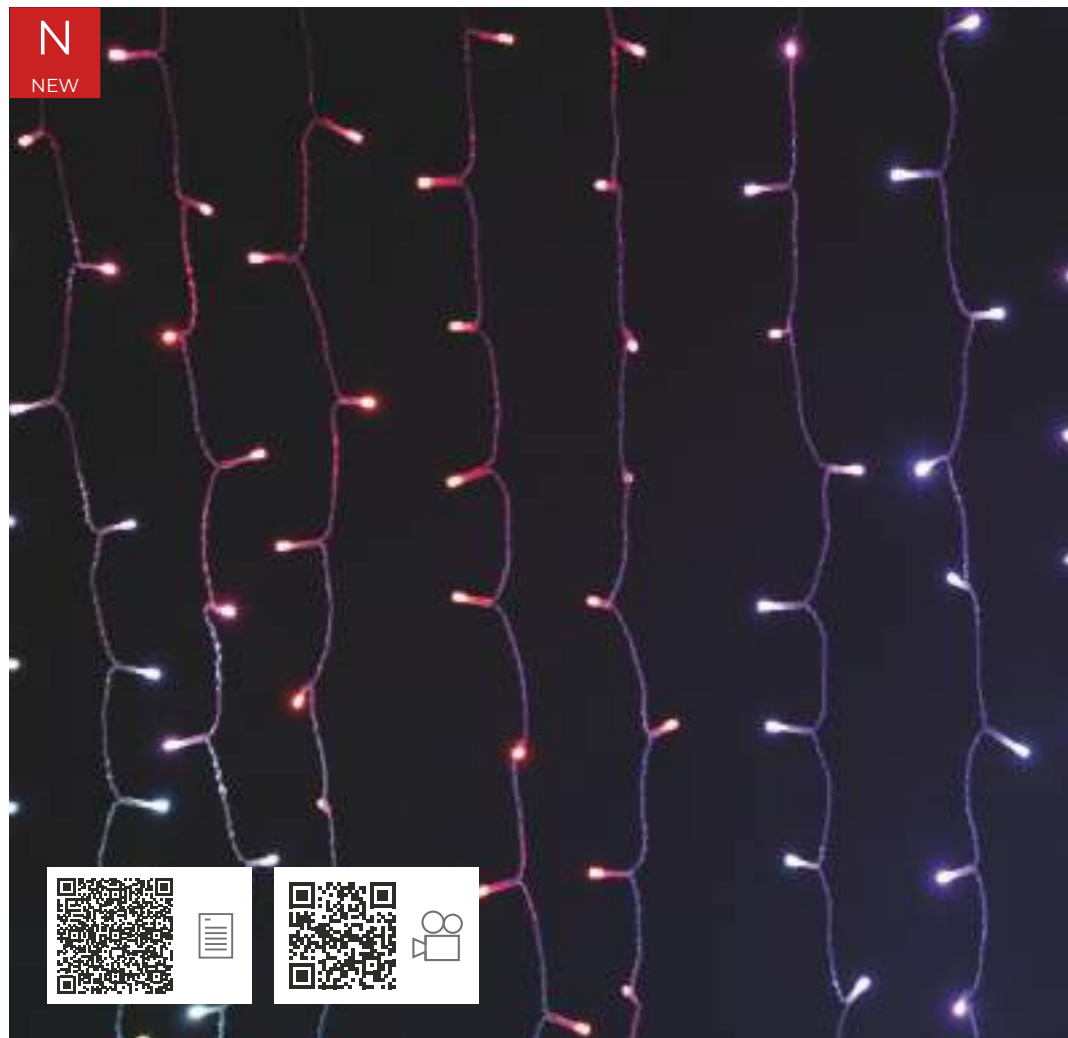





# SCREENLIGHT SMART RGB

control por APP



|   |              |
|---|--------------|
|  | 24V          |
|  | 50-60Hz      |
|  | CIII         |
|  | 1 CANAL      |
|  | IP44         |
|  | 3,5kg (N.W.) |
|  | INC.         |
|  | INC.         |
|  | 2ud          |

|   |   |   |
|---|---|---|
|  |  |  |
| 632973  |  |  |

|   |                           |
|---|---------------------------|
|  | 2x2m                      |
|  | 20<br>(2 tiras = 1 serie) |
|  | 400                       |
|  | 20                        |
| <b>W</b>  | 36W                       |
|  | NO<br>Empalmable          |

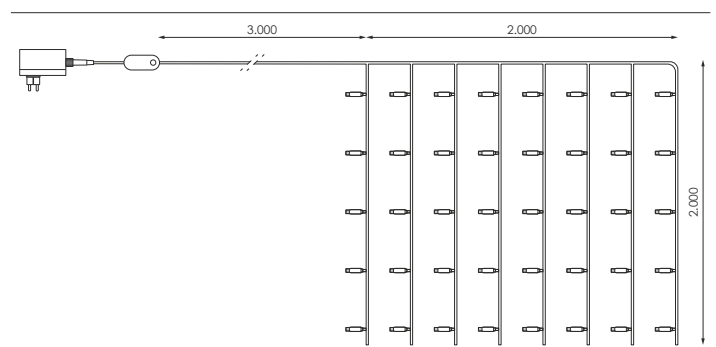

## Información/Information/Information/Informações

**Ñ/** Los efectos de cambio de color solo funcionan con la APP.

**E/** The color change effects only work with the APP.

**F/** Les effets de changement de couleur fonctionnent uniquement avec le APP.

**P/** Os efeitos de mudança de cor funcionam apenas com APP.

## Aviso/Warning/Avertissement/Aviso

**Ñ/** Para conseguir el IP44, el controlador y el transformador deben ir en una caja estanca.

**E/** To achieve IP44, the controller and transformer must be housed in a watertight enclosure.

**F/** Pour atteindre l'indice IP44, le contrôleur et le transformateur doivent être placés dans un boîtier étanche.

**P/** Para atingir o IP44, o controlador e o transformador devem ser alojados numa caixa estanque.





# flexiLIGHT LED

Maxibrillo RGB



⚡ 230V ac

Hz 50-60Hz

□ CII

⊙ 1 Canal/ 2 Vías

⊙ IP44 PLUG

IP65

∠ 120°

🌡️ -20°C~+60 °C

⊗ NO INC.

🌀 Rollo 50m

Ñ/ Exterior/Textura Lisa/Tapa final **INCLUIDA**  
 E/ Outside/Smooth Texture/End cap **INCLUDED**  
 F/ À l'extérieur/Texture Lisse/Couvercle **INCLUS**  
 P/ Exterior/Textura Lisa/Tampa final **INCLUÍDA**



599900



✂️ 1m

∅ 19x7mm

☀️ 60

W% 10W

W 500W

🔌 Max. 50m

⊙ Rollo 50m

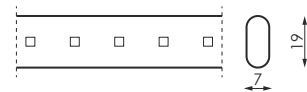

ESQUEMA INSTALACIÓN/  
 INSTALLATION SCHEME/  
 SCHEMA D'INSTALLATION/  
 ESQUEMA DE INSTALAÇÃO



+

Producto/Product  
 Produit/Produto

Accesorios (NO Incluidos) / Accessoires (NOT Included) / Accessories (NON Inclus) / Acessórios (NÃO Incluso)

+ INFO PAG. 292

599917  
 Controlador con mando a distancia

600972  
 Empalme

600965  
 Tapa final

N 619769  
 Extensión 15cm cable blanco

# flexiLIGHT LED

## Double Neon RGB

|           |                 |
|-----------|-----------------|
|           | 230V ac         |
| <b>Hz</b> | 50-60Hz         |
|           | CII             |
|           | 1 Canal/ 2 Vías |
|           | IP44 PLUG       |
|           | IP65            |
|           | 360°            |
|           | -20°C~+60 °C    |
|           | NO INC.         |
|           | Rollo 50m       |



**Ñ/ Exterior/Textura Lisa/Tapa final INCLUIDA**  
**E/ Outside/Smooth Texture/End cap INCLUDED**  
**F/ À L'extérieur/Texture Lisse/Couvercle INCLUS**  
**P/ Exterior/Textura Lisa/Tampa final INCLUIDA**

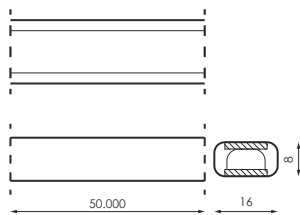

ESQUEMA INSTALACIÓN/  
INSTALLATION SCHEME/  
SCHEMA D'INSTALLATION/  
ESQUEMA DE INSTALAÇÃO



Producto/Product  
Produit/Produto

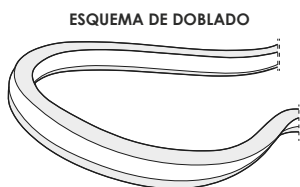

|          |           |
|----------|-----------|
|          | 1m        |
|          | 8x16mm    |
|          | 120       |
|          | 10W       |
| <b>W</b> | 500W      |
|          | Max. 50m  |
|          | Rollo 50m |

|        |  |  |
|--------|--|--|
|        |  |  |
| 599887 |  |  |

Accesorios (NO Incluidos) / Accessoires (NOT Included) / Accessories (NON Inclus) / Acessórios (NÃO Incluso)

+ INFO PAG. 292

|        |                                   |
|--------|-----------------------------------|
| 599894 | Controlador con mando a distancia |
|--------|-----------------------------------|

|        |                 |
|--------|-----------------|
| 600958 | Empalme 25x80mm |
|--------|-----------------|

|        |            |
|--------|------------|
| 600941 | Tapa final |
|--------|------------|

|          |                             |
|----------|-----------------------------|
| N 619752 | Extensión 15cm cable blanco |
|----------|-----------------------------|

[GRÁFICOS: Unidades en mm/ GRAPHICS: Units in mm/ GRAPHIQUES: Unités en mm/ GRÁFICOS: Unidades em mm]



# flexiLIGHT LED

## RGBWW



⚡ 230V dc

Hz 50-60Hz

□ CII

° IP65

△ 360°

🌡️ -20°C~+60 °C

⚖️/kg 8kg (N.W.)

⊗ NO INC.

⊗ NO INC.

🌀 Rollo 40m

Ñ/ Exterior/Textura lisa/Tapa final **INCLUIDA**.  
 E/ Outside/Smooth texture/ End cap **INCLUDED**.  
 F/ À L'extérieur/Texture lisse/ Couverture **INCLUS**.  
 P/ Exterior/Textura lisa/Tampa final **INCLUÍDA**.

|        |     |    |
|--------|-----|----|
|        | 💡   | ⊙  |
| 561273 | LED | 6W |

|     |           |
|-----|-----------|
| ✂️  | 1m        |
| ∅   | 13mm      |
| 💡   | 36        |
| W/% | 4,6W      |
| W   | 184W      |
| 🔗   | Max. 100m |
| 🌀   | Rollo 40m |

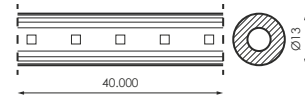

ESQUEMA INSTALACIÓN/  
 INSTALLATION SCHEME/  
 SCHEMA D'INSTALLATION/  
 ESQUEMA DE INSTALAÇÃO



### Aviso/Warning/Avertissement/Aviso

Ñ/ Los efectos de cambio de color solo funcionan con el controlador que es de **USO OBLIGATORIO**.

E/ The color change effects only work with the controller that is **OBLIGATORY**.

F/ Les effets de changement de couleur fonctionnent uniquement avec le contrôleur qui est **OBLIGATOIRE**.

P/ Os efeitos de mudança de cor funcionam apenas com o controlador que é **USO OBRIGATÓRIO**.

### Accesorios (NO Incluidos) / Accessoires (NOT Included) / Accessories (NON Inclus)/ Acessórios (NÃO Incluso)

+ INFO PAG. 292

Ñ/ Adaptador **NO INCLUIDO**.

E/ Adapter **NOT INCLUDED**.

F/ Adaptateur **NON INCLUS**.

P/ Adaptador **NÃO INCLUÍDO**.









|        |   |
|--------|---|
| 514514 | Controlador RGBWW con mando a distancia sin adaptador |
| 514491 | Controlador RGBWW pasarela DMX sin adaptador          |

|        |  |
|--------|--|
| 566520 | Controlador RGBWW sincronización GPS sin adaptador |
| 192453 | Adaptador blanco SMART-FLEXILIGHT                  |

|        |   |
|--------|---|
| 514507 | Controlador RGBWW sincronización Power line sin adaptador |
| 192477 | Adaptador negro SMART-FLEXILIGHT                          |

# flexiLIGHT LED

## RGB

|   |              |
|---|--------------|
|  | 230V dc      |
| <b>Hz</b>   | 50-60Hz      |
|  | CII          |
|  | IP65         |
|  | 360°         |
|  | -20°C~+60 °C |
|  | 8kg (N.W.)   |
|  | NO INC.      |
|  | NO INC.      |
|  | Rollo 40m    |



CC As Cancelas  
Santiago de Compostela

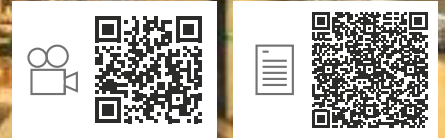



[GRÁFICOS: Unidades en mm/ GRÁFICOS: Units in mm/ GRAPHICS: Units in mm/ GRÁFICOS: Unidades em mm]

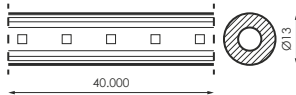



Ñ/ Exterior/Textura lisa/Tapa final **INCLUIDA**.  
E/ Outside/Smooth texture/ End cap **INCLUDED**.  
F/ À L'extérieur/Texture lisse/ Couvercle **INCLUS**.  
P/ Exterior/Textura lisa/Tampa final **INCLUIDA**.



ESQUEMA INSTALACIÓN/  
INSTALLATION SCHEME/  
SCHEMA D'INSTALLATION/  
ESQUEMA DE INSTALAÇÃO



|   |           |
|---|-----------|
|  | 1m        |
|  | 13mm      |
|  | 36        |
|  | 4,6W      |
| <b>W</b>  | 184W      |
|  | Max. 100m |
|  | Rollo 40m |

|   |   |   |
|---|---|---|
|  |  |  |
| 546676  |  |  |

### Aviso/Warning/Avertissement/Aviso

Ñ/ Los efectos de cambio de color solo funcionan con el controlador que es de **USO OBLIGATORIO**.

E/ The color change effects only work with the controller that is **OBLIGATORY**.

F/ Les effets de changement de couleur fonctionnent uniquement avec le contrôleur qui est **OBLIGATOIRE**.

P/ Os efeitos de mudança de cor funcionam apenas com o controlador que é **USO OBRIGATÓRIO**.

### Accesorios (NO Incluidos) / Accessoires (NOT Included) / Accessories (NON Inclus)/ Acessórios (NÃO Incluso)

+ INFO PAG. 292

Ñ/ Adaptador **NO INCLUIDO**.

E/ Adapter **NOT INCLUDED**.

F/ Adaptateur **NON INCLUS**.

P/ Adaptador **NÃO INCLuíDO**.

|        |   |
|--------|---|
| 571845 | Controlador RGB con mando a distancia sin adaptador |
| 486279 | Controlador RGB pasarela DMX sin adaptador          |

|        |   |
|--------|---|
| 600705 | Controlador RGB con mando a distancia sin adaptador |
| 192453 | Adaptador blanco SMART-FLEXILIGHT                   |

|        |  |
|--------|--|
| 454261 | Controlador RGB sincronización GPS sin adaptador |
| 192477 | Adaptador negro SMART-FLEXILIGHT                 |

|        |   |
|--------|---|
| 486262 | Controlador RGB sincronización Power line sin adaptador |
|--------|---|

# flexiLIGHT LED

CW-WW



⚡ 230V dc

Hz 50-60Hz

□ CII

° IP65

△ 360°

🌡️ -20°C~+60 °C

📊 8kg (N.W.)

✘<sub>C</sub> NO INC.

✘<sub>A</sub> NO INC.

🌀 Rollo 40m

Ñ/ Exterior/Textura lisa/Tapa final **INCLUIDA**.  
 E/ Outside/Smooth texture/ End cap **INCLUDED**.  
 F/ À L'extérieur/Texture lisse/ Couvercle **INCLUS**.  
 P/ Exterior/Textura lisa/Tampa final **INCLUÍDA**.



|        |  |  |
|--------|--|--|
|        |  |  |
| 486347 |  |  |

|     |           |
|-----|-----------|
|     | 1m        |
| ∅   | 13mm      |
|     | 36        |
| W/⊘ | 4,6W      |
| W   | 184W      |
|     | Max. 55m  |
|     | Rollo 40m |

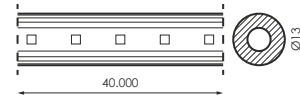

ESQUEMA INSTALACIÓN/  
 INSTALLATION SCHEME/  
 SCHEMA D'INSTALLATION/  
 ESQUEMA DE INSTALAÇÃO



Producto/Product  
 Produit/Produto

## Aviso/Warning/Avertissement/Aviso

Ñ/ Los efectos de cambio de color solo funcionan con el controlador que es de **USO OBLIGATORIO**.

E/ The color change effects only work with the controller that is **OBLIGATORY**.

F/ Les effets de changement de couleur fonctionnent uniquement avec le contrôleur qui est **OBLIGATOIRE**.

P/ Os efeitos de mudança de cor funcionam apenas com o controlador que é **USO OBRIGATÓRIO**.

## Accesorios (NO Incluidos) / Accessoires (NOT Included) / Accessories (NON Inclus)/ Acessórios (NÃO Incluso)

+ INFO PAG. 292

Ñ/ Adaptador **NO INCLUIDO**.

E/ Adapter **NOT INCLUDED**.

F/ Adaptateur **NON INCLUS**.

P/ Adaptador **NÃO INCLUÍDO**.

|        |   |
|--------|---|
| 486309 | Controlador CW-WW con mando a distancia sin adaptador |
| 486330 | Controlador CW-WW pasarela DMX sin adaptador          |

|        |  |
|--------|--|
| 486316 | Controlador CW-WW sincronización GPS sin adaptador |
| 192453 | Adaptador blanco SMART-FLEXILIGHT                  |

|        |   |
|--------|---|
| 486323 | Controlador CW-WW sincronización Power line sin adaptador |
| 192477 | Adaptador negro SMART-FLEXILIGHT                          |



# STRING **PLUS** 100

RGBWW

|           |              |
|-----------|--------------|
|           | 230V dc      |
| <b>Hz</b> | 50-60Hz      |
|           | CII          |
|           | 1 CANAL      |
|           | IP65         |
|           | -20°C~+60 °C |
|           | 1kg (N.W.)   |
|           | NO INC.      |
|           | 10ud         |

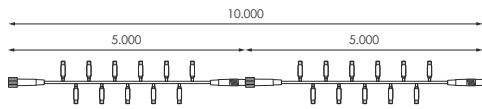

ESQUEMA INSTALACIÓN/  
INSTALLATION SCHEME/  
SCHEMA D'INSTALLATION/  
ESQUEMA DE INSTALAÇÃO



Producto/Product  
Produit/Produto

|          |                    |
|----------|--------------------|
|          | 10m<br>(5m x 2seg) |
|          | 5m                 |
|          | 100                |
|          | 50                 |
|          | 5,3W               |
| <b>W</b> | 10,6W              |
|          | 100m               |

|        |  |  |
|--------|--|--|
|        |  |  |
| 514477 |  |  |
| 514484 |  |  |

## Aviso/Warning/Avertissement/Aviso

**Ñ**/ Los efectos de cambio de color solo funcionan con el controlador que es de **USO OBLIGATORIO** y con 10m de String Plus RGBWW.

**E**/ The color change effects only work with the controller that is **OBLIGATORY** and with 10m of String Plus RGBWW.

**F**/ Les effets de changement de couleur fonctionnent uniquement avec le contrôleur qui est **OBLIGATOIRE** et avec 10m de String Plus RGBWW.

**P**/ Os efeitos de mudança de cor funcionam apenas com o controlador que é **USO OBLIGATORIO** e com 10m de String Plus RGBWW.

## Accesorios (NO Incluidos) / Accessoires (NOT Included) / Accessories (NON Inclus)/ Acessórios (NÃO Incluso)

+ INFO PAG. 292

**Ñ**/ Compatible con todos los accesorios **SMART LINK**

**E**/ Compatible with all **SMART LINK** accessories

514514

Controlador RGBWW con mando a distancia.

514507

Controlador RGBWW sincronización Power line.

566520

Controlador RGBWW sincronización GPS. Máx.100m/línea

514491

Controlador RGBWW pasarela DMX.

**F**/ Compatible avec tous les accessoires **SMART LINK**

**P**/ Compatível com todos os acessórios **SMART LINK**

# STRING **PLUS** 100

## RGB



⚡ 230V dc

Hz 50-60Hz

□ CII

⊙ 1 CANAL

⊙ IP65

🌡️ -20°C~+60 °C

📊 1kg (N.W.)

⊗ NO INC.

📦 10ud

|        |  |  |
|--------|--|--|
|        |  |  |
| 571814 |  |  |
| 571821 |  |  |

|   |                    |
|---|--------------------|
| ↔ | 10m<br>(5m x 2seg) |
| ⏏ | 5m                 |
| 💡 | 100                |
| 💡 | 50                 |
| ⏏ | 4,6W               |
| W | 9,2W               |
| 🔗 | 100m               |

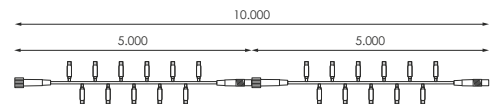

ESQUEMA INSTALACIÓN/  
INSTALLATION SCHEME/  
SCHEMA D'INSTALLATION/  
ESQUEMA DE INSTALAÇÃO



+ Producto/Product  
Produit/Produto

### Aviso/Warning/Avertissement/Aviso

Ñ/ Los efectos de cambio de color solo funcionan con el controlador que es de **USO OBLIGATORIO** y con 10m de String Plus RGB.

E/ The color change effects only work with the controller that is **OBLIGATORY** and with 10m of String Plus RGB.

F/ Les effets de changement de couleur fonctionnent uniquement avec le contrôleur qui est **OBLIGATOIRE** et avec 10m de String Plus RGB.

P/ Os efeitos de mudança de cor funcionam apenas com o controlador que é **USO OBRIGATÓRIO** e com 10m de String Plus RGB.

### Accesorios (NO Incluidos) / Accessoires (NOT Included) / Accessories (NON Inclus)/ Acessórios (NÃO Incluso)

+ INFO PAG. 292

Ñ/ Compatible con todos los accesorios **SMART LINK**

E/ Compatible with all **SMART LINK** accessories

F/ Compatible avec tous les accessoires **SMART LINK**

P/ Compatível com todos os acessórios **SMART LINK**

571845

Controlador RGB con mando a distancia sin adaptador

486279

Controlador RGB pasarela DMX sin adaptador

600705

Controlador RGB con mando a distancia sin adaptador

454261

Controlador RGB sincronización GPs sin adaptador

486262

Controlador RGB sincronización Power line sin adaptador

# STRING **PLUS** 100

CW-WW

|           |              |
|-----------|--------------|
|           | 230V dc      |
| <b>Hz</b> | 50-60Hz      |
|           | CII          |
|           | 1 CANAL      |
|           | IP65         |
|           | -20°C~+60 °C |
|           | 1kg (N.W.)   |
|           | NO INC.      |
|           | 10ud         |



San Andres y Sauces  
Las Palmas

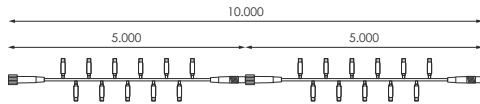
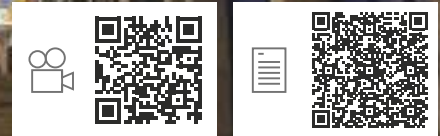

ESQUEMA INSTALACIÓN/  
INSTALLATION SCHEME/  
SCHEMA D'INSTALLATION/  
ESQUEMA DE INSTALAÇÃO



Producto/Product  
Produit/Produto

|          |                    |
|----------|--------------------|
|          | 10m<br>(5m x 2seg) |
|          | 5m                 |
|          | 100                |
|          | 50                 |
|          | 5,3W               |
| <b>W</b> | 10,6W              |
|          | 100m               |

|        |  |  |
|--------|--|--|
|        |  |  |
| 486286 |  |  |
| 486293 |  |  |

## Aviso/Warning/Avertissement/Aviso

**Ñ/** Los efectos de cambio de color solo funcionan con el controlador que es de **USO OBLIGATORIO** y con 10m de String Plus CW/WW.

**E/** The color change effects only work with the controller that is **OBLIGATORY** and with 10m of String Plus CW/WW.

**F/** Les effets de changement de couleur fonctionnent uniquement avec le contrôleur qui est **OBLIGATOIRE** et avec 10m de String Plus CW/WW.

**P/** Os efeitos de mudança de cor funcionam apenas com o controlador que é **USO OBLIGATÓRIO** e com 10m de String Plus CW/WW.

## Accesorios (NO Incluidos) / Accessoires (NOT Included) / Accessories (NON Inclus)/ Acessórios (NÃO Incluso)

+ INFO PAG. 292

**Ñ/** Compatible con todos los accesorios **SMART LINK**

**E/** Compatible with all **SMART LINK** accessories

**F/** Compatible avec tous les accessoires **SMART LINK**

**P/** Compatível com todos os acessórios **SMART LINK**

486309

Controlador CW-WW con mando a distancia. (486293)

486330

Controlador CW-WW pasarela DMX.

N 628389

Controlador CW-WW con mando a distancia. (486286)

486316

Controlador CW-WW sincronización GPS.

486323

Controlador CW-WW sincronización Power line.



# SCREENLIGHT 400

RGBWW



SMART LINK 

 230V dc

Hz 50-60Hz

 CII

 1 CANAL

 IP65

 -20°C~+60 °C

 1,6kg (N.W.)





 NO INC.

 5ud



Arucas  
Canarias

|   |   |   |
|---|---|---|
|  |  |  |
| 588850  |  |  |

|   |                           |
|---|---------------------------|
|  | 2x2m                      |
|  | 20<br>(2 tiras = 1 serie) |
|  | 400                       |
|  | 20                        |
| W   | 46W                       |
|  | 7sets                     |

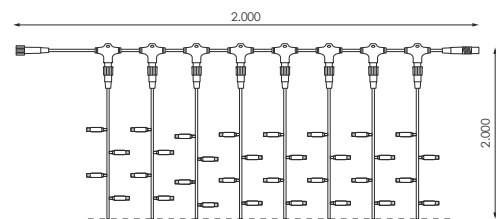

ESQUEMA INSTALACIÓN/  
INSTALLATION SCHEME/  
SCHEMA D'INSTALLATION/  
ESQUEMA DE INSTALAÇÃO



+ Producto/Product  
Produit/Produto

## Aviso/Warning/Avertissement/Aviso

**Ñ/** Los efectos de cambio de color solo funcionan con el controlador que es de **USO OBLIGATORIO**.

**E/** The color change effects only work with the controller that is **OBLIGATORY**.

**F/** Les effets de changement de couleur fonctionnent uniquement avec le contrôleur qui est **OBLIGATOIRE**.

**P/** Os efeitos de mudança de cor funcionam apenas com o controlador que é **USO OBRIGATÓRIO**.

## Accesorios (NO Incluidos) / Accessoires (NOT Included) / Accessories (NON Inclus)/ Acessórios (NÃO Incluso)

+ INFO PAG. 292

**Ñ/** Compatible con todos los accesorios **SMART LINK**

**E/** Compatible with all **SMART LINK** accessories

**F/** Compatible avec tous les accessoires **SMART LINK**

**P/** Compatível com todos os acessórios **SMART LINK**

514514

Controlador RGBWW con mando a distancia.

566520

Controlador RGBWW sincronización GPS.

514507

Controlador RGBWW sincronización Power line.

514491

Controlador RGBWW pasarela DMX.

# ICICLE 174

RGBWW

|           |               |
|-----------|---------------|
|           | 230V dc       |
| <b>Hz</b> | 50-60Hz       |
|           | CII           |
|           | 1 CANAL       |
|           | IP65          |
|           | -20°C~+60 °C  |
|           | 1,75kg (N.W.) |
|           | NO INC.       |
|           | 10ud          |



SMART LINK



[GRÁFICOS: Unidades en mm/GRÁFICOS: Units in mm/GRAPHICS: Units in mm/GRÁFICOS: Unidades em mm]

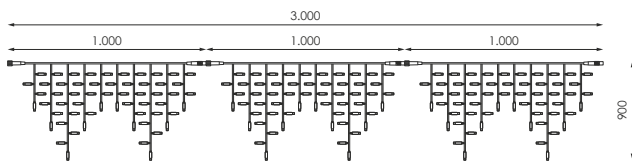

ESQUEMA INSTALACIÓN/  
INSTALLATION SCHEME/  
SCHEMA D'INSTALLATION/  
ESQUEMA DE  
INSTALAÇÃO



Producto/Product  
Produit/Produto

|          |                       |
|----------|-----------------------|
|          | 3x0,9m<br>(1m x 3seg) |
|          | 3                     |
|          | 174                   |
|          | 58                    |
| <b>W</b> | 13,8W                 |
|          | 15sets                |

|        |  |  |
|--------|--|--|
|        |  |  |
| 561464 |  |  |

Aviso/Warning/Avertissement/Aviso

Ñ/ Los efectos de cambio de color solo funcionan con el controlador que es de **USO OBLIGATORIO**.

E/ The color change effects only work with the controller that is **OBLIGATORY**.

F/ Les effets de changement de couleur fonctionnent uniquement avec le contrôleur qui est **OBLIGATOIRE**.

P/ Os efeitos de mudança de cor funcionam apenas com o controlador que é **USO OBRIGATÓRIO**.

Accesorios (NO Incluidos) / Accessoires (NOT Included) / Accessories (NON Inclus)/ Acessórios (NÃO Incluso)

+ INFO PAG. 292

Ñ/ Compatible con todos los accesorios **SMART LINK**

E/ Compatible with all **SMART LINK** accessories

F/ Compatible avec tous les accessoires **SMART LINK**

P/ Compatível com todos os acessórios **SMART LINK**

514514

Controlador RGBWW con mando a distancia.

566520

Controlador RGBWW sincronización GPS.

514507

Controlador RGBWW sincronización Power line.

514491

Controlador RGBWW pasarela DMX.

# CONTROLADORES

## RGBWW/RGB/CW-WW

### CONTROLADOR

Sincronización con mando a distancia

514514 - RGBWW  
571845/600705 - RGB  
486309/628389 - CW/WW



### CONTROLADOR

Sincronización mediante satélite GPS.  
Cambio secuencial cada 15segundos.  
SOLO uso exterior.

566520 - RGBWW  
454261 - RGB  
486316 - CW/WW



### CONTROLADOR

Sincronización con línea eléctrica.  
Cambio secuencial cada 15segundos

514507 - RGBWW  
486262 - RGB  
486323 - CW/WW

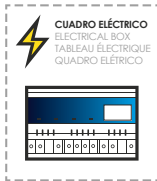

### CONTROLADOR/PASARELA DMX

Stand-Alone  
Cambio secuencial cada 15segundos  
si no recibe señal DMX

514491 - RGBWW  
486279 - RGB  
486330 - CW/WW

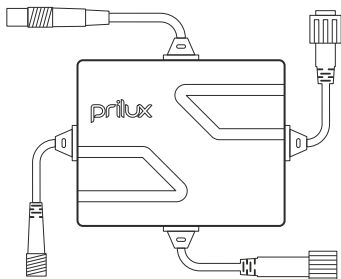

Controladores RGBWW / Controlador RGB (600705):

Serie: Máx. 3.600leds

Paralelo: Máx. 4.000leds

Controladores RGB / CW-WW:

Máx. 2.000leds

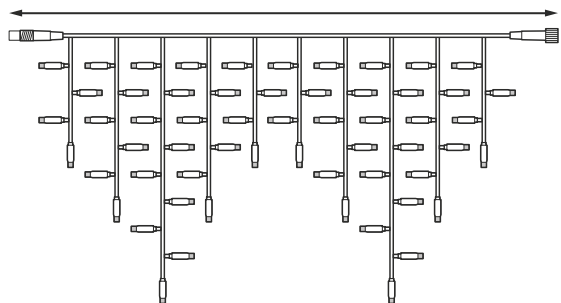
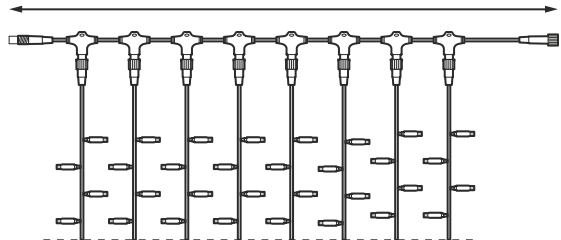
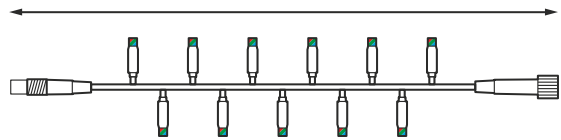
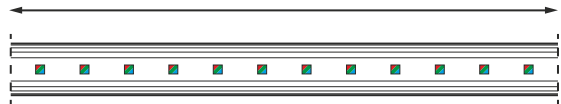



# CONTROLADORES

486279/486330/514491

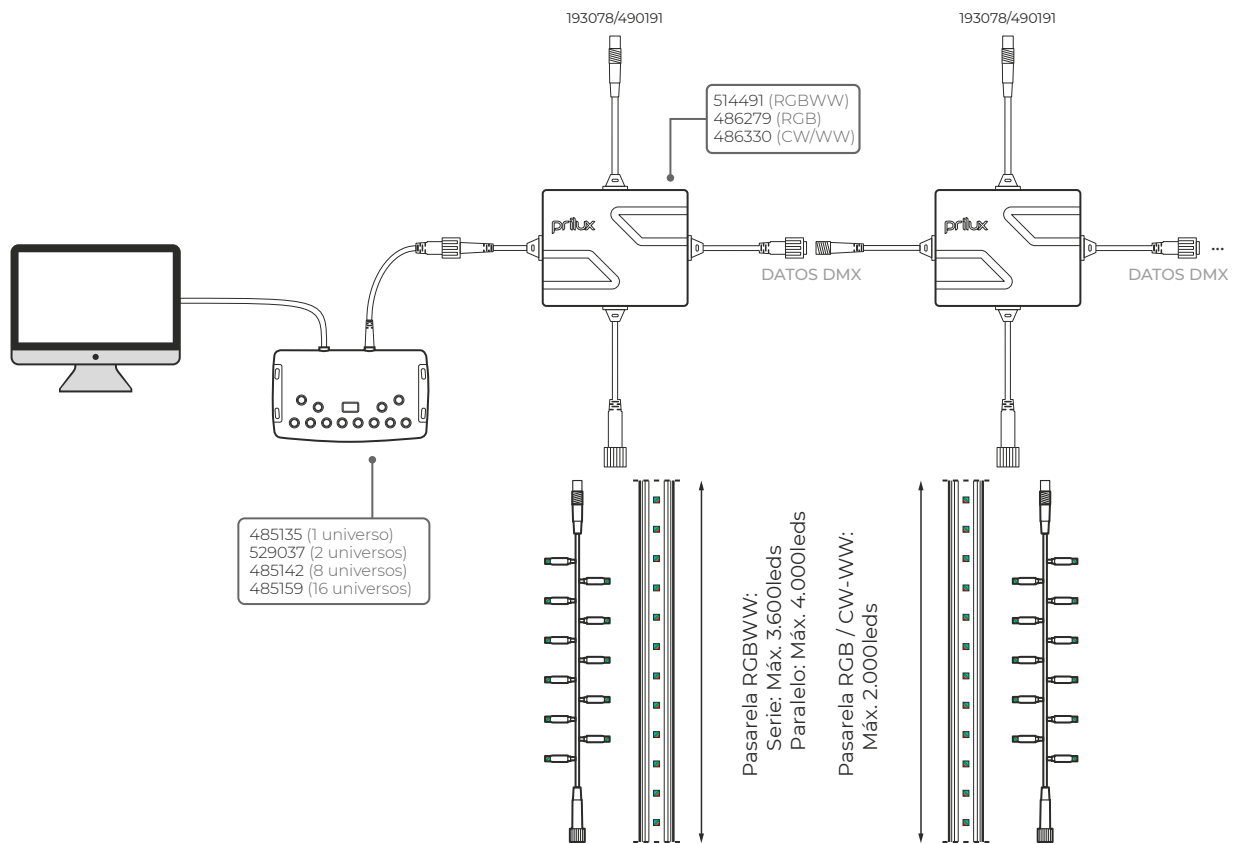

| CÓDIGO CONTROLADOR DMX | UNIVERSOS    | MÁX. CONTROLADORES A EMPALMAR |
|------------------------|--------------|-------------------------------|
| 485135                 | 1 universo   | 512 controladores             |
| 485142                 | 8 universos  | 4.096 controladores           |
| 485159                 | 16 universos | 8.192 controladores           |

Accesorios (NO Incluidos) / Accessoires (NOT Included) / Accessories (NON Inclus) / Acessórios (NÃO Incluso)

+ INFO PAG. 292

**N/** Accesorios y cable de alimentación **NO INCLUIDOS** para utilizar entre pasarelas si hay distancia entre ellas.

**E/** Accessories and power cable **NOT INCLUDED** to be used between walkways if there is distance between them.

**F/** Accessoires et câble d'alimentation **NON INCLUS** à utiliser entre passerelles s'il existe une distance suffisante entre elles.

**P/** Acessórios e cabo de alimentação **NÃO INCLuíDO** para ser usado entre passarelas se houver distância entre eles.

| 490207 | Extensión DMX 1m                  |
|--------|-----------------------------------|
| 490214 | Extensión DMX 3m                  |
| 490221 | Extensión DMX 5m                  |
| 490245 | Direccionador caja DMX            |
| 193078 | Cable alimentación con shuko 1,5m |
| 490191 | Cable alimentación sin shuko 1m   |

# STRING **PLUS** 100 24V

Transformador



|           |              |
|-----------|--------------|
|           | 24V dc       |
| <b>Hz</b> | 50-60Hz      |
|           | CIII         |
|           | 1 CANAL      |
|           | IP44         |
|           | -20°C~+60 °C |
|           | 0,8kg (N.W.) |
|           | NO INC.      |
|           | NO INC.      |
|           | NO INC.      |
|           | 10ud         |



|        |  |  |
|--------|--|--|
|        |  |  |
| 486378 |  |  |
|        |  |  |

|          |                    |
|----------|--------------------|
|          | 10m<br>(5m x 2seg) |
|          | 5m                 |
|          | 100                |
|          | 50                 |
|          | 3,6W               |
| <b>W</b> | 7,2W               |
|          | 40m                |

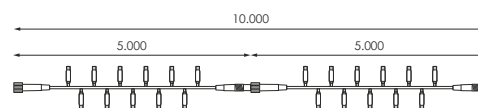

ESQUEMA INSTALACIÓN/  
 INSTALLATION SCHEME/  
 SCHEMA D'INSTALLATION/  
 ESQUEMA DE INSTALAÇÃO

+ + + Producto/Product  
Produit/Produto

# STRING **PLUS** 100 24V

## Transformador

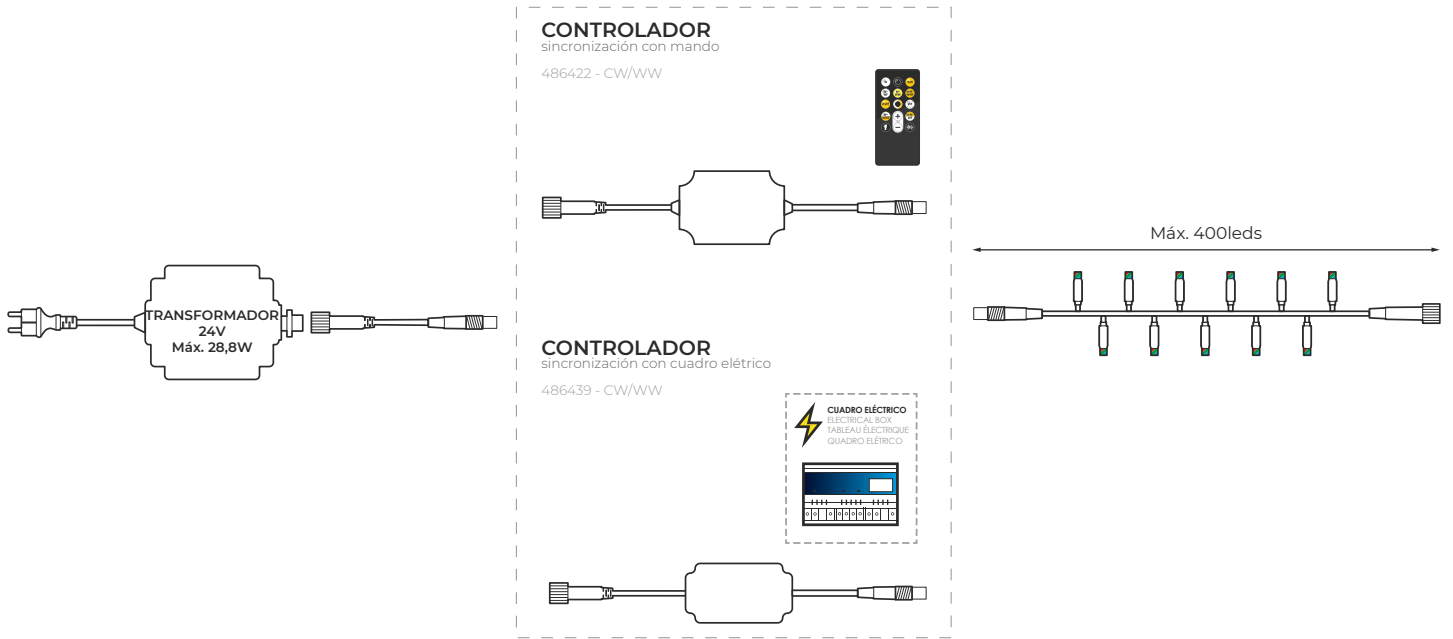

[GRÁFICOS: Unidades en mm/GRÁFICOS: Units in mm/GRAPHIQUES: Unités en mm/GRÁFICOS: Unidades em mm]

**Ñ/** Los efectos de cambio de color solo funcionan con el controlador que es de **USO OBLIGATORIO**.

**E/** The color change effects only work with the controller that is **OBLIGATORY**.

**F/** Les effets de changement de couleur fonctionnent uniquement avec le contrôleur qui est **OBLIGATOIRE**.

**P/** Os efeitos de mudança de cor funcionam apenas com o controlador que é **USO OBRIGATÓRIO**.

Aviso/Warning/Avertissement/Aviso

Accesorios (NO Incluidos) / Accessoires (NOT Included) / Accessories (NON Inclus) / Acessórios (NÃO Incluso)  
+ INFO PAG. 292

**Ñ/**Compatible con todos los accesorios **24V**

**E/** Compatible with all **24V** accessories

**F/** Compatible avec tous les accessoires **24V**

**P/** Compatível com todos os acessórios **24V**

486422

Controlador CW-WW con mando a distancia. Máx. 400leds.  
Transformador

486439

Controlador CW-WW sincronización Power line. Máx. 400leds.  
Transformador

149198

Transformador 28,8W



# STRING **PLUS** 100 24V

## Fuente alimentación



Gavá  
Barcelona

⚡ 24V dc

Hz 50-60Hz

◇ CIII

☺ 1 CANAL

°° IP44

🌡 -20°C~+60 °C

⚖/kg 0,8kg (N.W.)

⊗ NO INC.

⊗ NO INC.

📏 10ud



|          |  |  |
|----------|--|--|
|          |  |  |
| 588867   |  |  |
| 486385 * |  |  |

|   |                    |
|---|--------------------|
| ↔ | 10m<br>(5m x 2seg) |
| ⏟ | 5m                 |
| 💡 | 100                |
| ☀ | 50                 |
| ⏟ | 3,6W               |
| W | 7,2W               |
| ⚙ | 40m                |

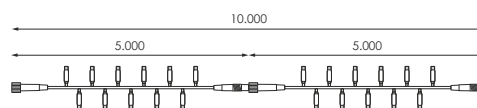

ESQUEMA INSTALACIÓN/  
INSTALLATION SCHEME/  
SCHEMA D'INSTALLATION/  
ESQUEMA DE INSTALAÇÃO

⊗ PS + ⊗ C

Producto/Product  
Produit/Produto

\*Hasta fin de existencias/\* Until end of stock/\* Jusqu'à épuisement des stocks/\* Enquanto os estoques durarem

# STRING **PLUS** 100 24V

## Fuente alimentación

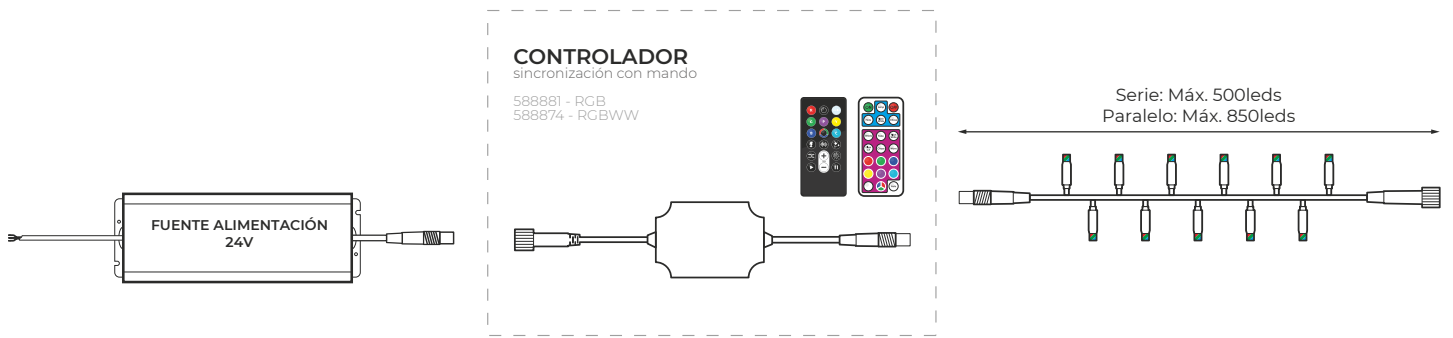

### Aviso/Warning/Avertissement/Aviso

Ñ/ Los efectos de cambio de color solo funcionan con el controlador que es de **USO OBLIGATORIO**.

E/ The color change effects only work with the controller that is **OBLIGATORY**.

F/ Les effets de changement de couleur fonctionnent uniquement avec le contrôleur qui est **OBLIGATOIRE**.

P/ Os efeitos de mudança de cor funcionam apenas com o controlador que é **USO OBRIGATÓRIO**.

### Accesorios (NO Incluidos) / Accessoires (NOT Included) / Accessories (NON Inclus)/ Acessórios (NÃO Incluso)

+ INFO PAG. 292

Ñ/Compatible con todos los accesorios **24V**

E/ Compatible with all **24V** accessories

F/ Compatible avec tous les accessoires **24V**

P/ Compatível com todos os acessórios **24V**

588881

Controlador RGB con mando a distancia. Fuente

588874

Controlador RGBWW con mando a distancia. Fuente

488440

Fuente alimentación 30W 24V

488457

Fuente alimentación 60W 24V

488464

Fuente alimentación 100W 24V

481687

Fuente alimentación 150W 24V

571968

Fuente alimentación 200W 24V

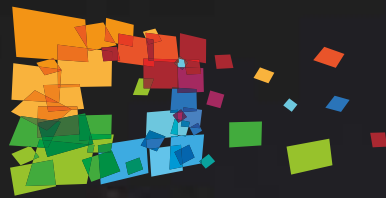

# PIXELMAX

## Control pixel a pixel

Con la gama de productos Pixelmax es posible ofrecer efectos dinámicos realmente diferenciadores. Gracias a la tecnología Pixelmax disponemos de control individual de cada LED, tanto de color como de flujo emitido, desde un puesto de control centralizado lo que permite que convirtamos nuestra instalación en una pantalla de efectos de luz a medida. Con nuestra gama de controladores es posible cubrir las necesidades que exija cada proyecto, desde efectos dinámicos en pequeños motivos hasta convertir la fachada de un edificio en una pantalla RGB/RGBW sobre la que reproducir vídeos.

## Pixel to pixel control

With the Pixelmax product range it is possible to offer truly differentiating dynamic effects. Thanks to Pixelmax technology we have individual control of each LED, both color and flow emitted, from a centralized control post, which allows us to turn our installation into a custom light effects screen. With our range of controllers it is possible to meet the needs of each project, from dynamic effects in small motifs to converting the facade of a building into an RGB/RGBW screen on which to play videos.

## Contrôle pixel à pixel

La gamme de produits Pixelmax permet d'offrir des effets dynamiques véritablement différenciants. Grâce à la technologie Pixelmax, nous avons un contrôle individuel de chaque LED, à la fois en couleur et en flux émis, depuis un poste de contrôle centralisé, ce qui nous permet de transformer notre installation en un écran à effets de lumière personnalisé. Avec notre gamme de contrôleurs, il est possible de répondre aux besoins de chaque projet, des effets dynamiques dans les petits motifs à la conversion de la façade d'un bâtiment en un écran RGB/RGBW sur lequel lire des vidéos.

## Controle de pixel para pixel

Com a gama de produtos Pixelmax, é possível oferecer efeitos dinâmicos verdadeiramente diferenciadores. Graças à tecnologia Pixelmax, temos um controle individual de cada LED, tanto em cores quanto em fluxo, a partir de um posto de controle centralizado, o que nos permite transformar nossa instalação em uma tela de efeitos de luz personalizada. Com a nossa gama de controladores, é possível atender às necessidades de cada projeto, desde efeitos dinâmicos em pequenos motivos até a conversão da fachada de um edifício em uma tela RGB/RGBW na qual reproduzir vídeos.





FACHADA AYTO.



CONO



# STRING PIXELMAX RGB

12V

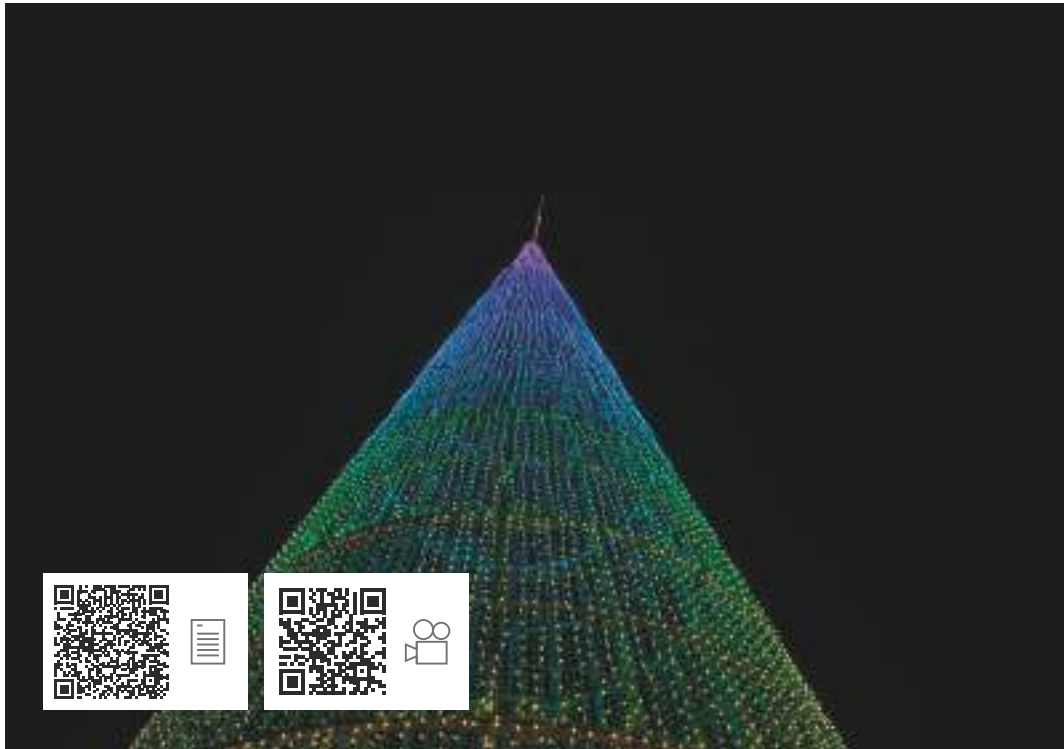

⚡ 12V dc

Hz 50-60Hz

◇ CIII

° IP68

🌡️ -20°C~+60 °C

📊 1,2kg (N.W.)

⊗ NO INC.

⊗ NO INC.

📦 20ud

Ñ/ Tapa final **NO INCLUIDA.**  
 E/ End cap **NOT INCLUDED.**  
 F/ Couvercle **NON INCLUS.**  
 P/ Tampa final **NAO INCLUÍ-DA.**

484275

↔ 2m

💡 20

W 12W

🔌 Según Controlador

2.000

ESQUEMA INSTALACIÓN/  
 INSTALLATION SCHEME/  
 SCHEMA D'INSTALLATION/  
 ESQUEMA DE INSTALAÇÃO

⊗ PS + ⊗ C + Producto/Product  
 Produit/Produto

594745

↔ 4m

💡 40

W 24W

🔌 Según Controlador

4.000

ESQUEMA INSTALACIÓN/  
 INSTALLATION SCHEME/  
 SCHEMA D'INSTALLATION/  
 ESQUEMA DE INSTALAÇÃO

⊗ PS + ⊗ C + Producto/Product  
 Produit/Produto

563734

↔ 4,8m

💡 50

W 30W

🔌 Según Controlador

4.800

ESQUEMA INSTALACIÓN/  
 INSTALLATION SCHEME/  
 SCHEMA D'INSTALLATION/  
 ESQUEMA DE INSTALAÇÃO

⊗ PS + ⊗ C + Producto/Product  
 Produit/Produto

484268

↔ 5m

💡 50

W 30W

🔌 Según Controlador

5.000

ESQUEMA INSTALACIÓN/  
 INSTALLATION SCHEME/  
 SCHEMA D'INSTALLATION/  
 ESQUEMA DE INSTALAÇÃO

⊗ PS + ⊗ C + Producto/Product  
 Produit/Produto

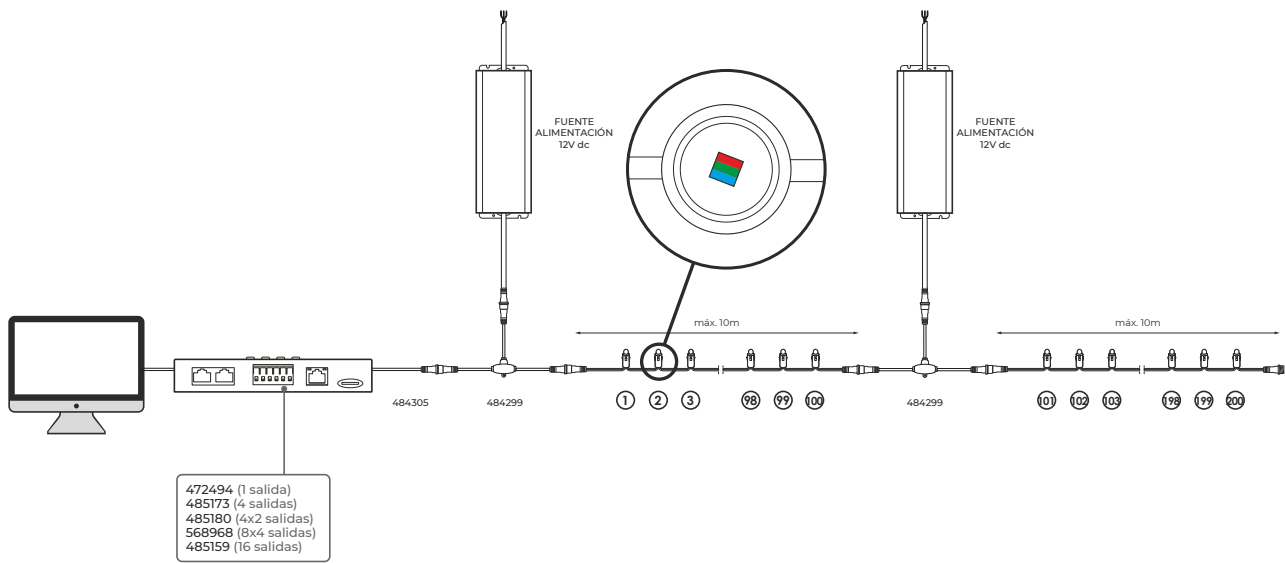

Accesorios (NO Incluidos) / Accessoires (NOT Included) / Accessories (NON Inclus)/ Acessórios (NÃO Incluso)  
+ INFO PAG. 292

|   |  |   |  |
|---|--|---|--|
| 472494                                      | 485173   | 485180                                    | 568968                                       |
| Controlador DMX-SPI<br>1 salida             | Controlador Master SPI<br>4 salidas                      | Controlador Master SPI<br>4x2 salidas     | Controlador Master DMX512-SPI<br>8x4 salidas |
| 485159                                      | 485135   | 529037                                    | 485142                                       |
| Controlador Master DMX512-SPI<br>16 salidas | Controlador Master DMX512<br>1 universo                  | Controlador Master DMX512<br>2 universos  | Controlador Master DMX512<br>8 universos     |
| 485166                                      | 484305   | 484299                                    | 484343                                       |
| Amplificador señal DMX 3 salidas            | Conector a fuente alimentación                           | Conector T SPI<br>(2 entradas/1 salida)   | Conector T SPI<br>(1 entrada/2 salidas)      |
| 484350                                      | 484367   | 484312                                    | 518154                                       |
| Conector 3 SPI<br>(1 entrada/4 salidas)     | Conector 5 SPI<br>(1 entrada/6 salidas)                  | Extensión 25cm SPI                        | Extensión 50cm SPI                           |
| 484329                                      | 484336   | 518161                                    | 518178                                       |
| Extensión 1m SPI                            | Extensión 3m SPI   | Extensión 5m SPI                          | Extensión 10m SPI                            |
| 594738                                      | 580335   | 580342                                    | 580359                                       |
| Tapa final                                  | Conector macho-hembra power<br>stopper 15cm cable blanco | Conector macho-macho 15cm cable<br>blanco | Conector hembra-hembra 15cm<br>cable blanco  |
| 484282                                      | 563161   |   |  |
| Fuente alimentación 60W 12V IP66            | Fuente alimentación 250W 12V IP66                        |   |  |



# STRING PIXELMAX RGB

12V

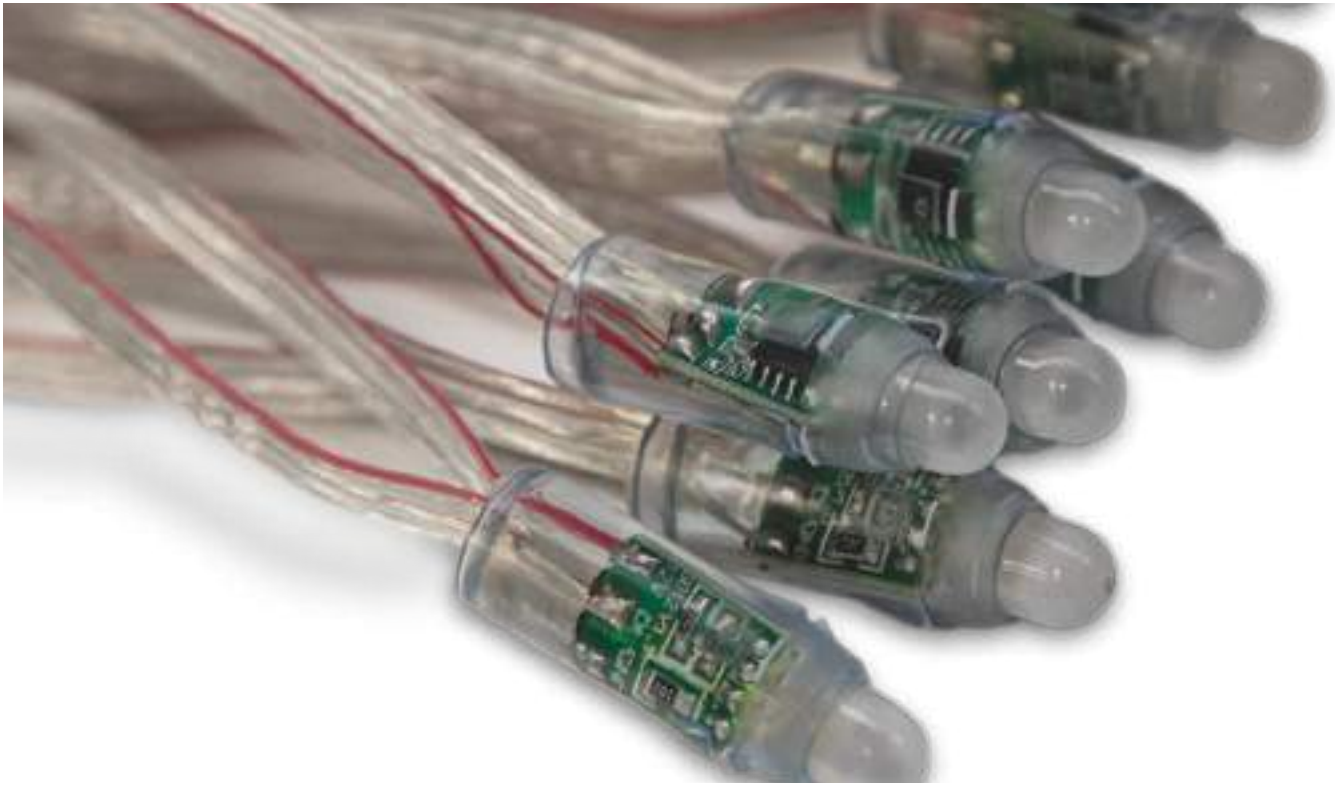

## CONEXIÓN EN PARALELO ESQUEMA INSTALACIÓN 1 SALIDA

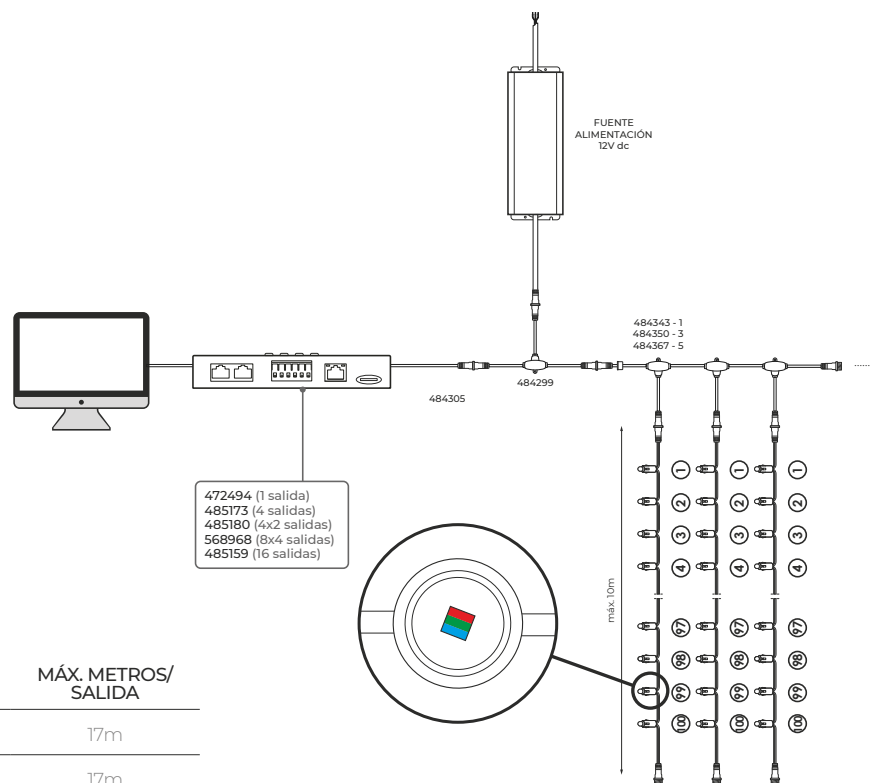

- 472494 (1 salida)
- 485173 (4 salidas)
- 485180 (4x2 salidas)
- 568968 (8x4 salidas)
- 485159 (16 salidas)

| CÓDIGO CONTROLADOR | Nº SALIDAS  | MÁX. PÍXELES   | MÁX. METROS/SALIDA |
|--------------------|-------------|----------------|--------------------|
| 472494             | 1 salida    | 170 píxeles    | 17m                |
| 485173             | 4 salidas   | 680 píxeles    | 17m                |
| 485180             | 4x2 salidas | 1.360 píxeles  | 34m                |
| 568968             | 8x4 salidas | 5.440 píxeles  | 68m                |
| 485159             | 16 salidas  | 21.760 píxeles | 136m               |

# Diseñamos tus Espacios

desde el proyecto  
hasta la realización



## Diseñamos tus Espacios

En el Departamento de Proyectos de Grupo Prilux realizamos proyectos de decoración, sin compromiso, donde se planifican y proyectan las mejores soluciones para cubrir espacios y elementos arquitectónicos, convirtiéndolos en ambientes donde vivir una auténtica experiencia lumínica.

## We design your Spaces

In the Prilux Group Projects Department we carry out decoration projects, without obligation, where the best solutions are planned and projected to cover spaces and architectural elements, turning them into environments where you can live an authentic lighting experience.

## Nous concevons vos espaces

Dans le département Projets du Groupe Prilux, nous réalisons des projets de décoration, sans engagement, où les meilleures solutions sont planifiées et projetées pour couvrir les espaces et les éléments architecturaux, en les transformant en environnements où vous pouvez vivre une expérience d'éclairage authentique.

## Nós projetamos seus espaços

No Departamento de Projetos do Grupo Prilux realizamos projetos de decoração, sem compromisso, onde as melhores soluções são planejadas e projetadas para cobrir espaços e elementos arquitetônicos, transformando-os em ambientes onde pode viver uma autêntica experiência de iluminação.

# DOT DMX PIXELMAX RGBW

24V



|  |              |
|--|--------------|
|  | 24V dc       |
|  | 50-60Hz      |
|  | CIII         |
|  | IP65         |
|  | -20°C~+60 °C |
|  | 1,2kg (N.W.) |
|  | NO INC.      |
|  | NO INC.      |
|  | 10ud         |

|        |  |  |
|--------|--|--|
|        |  |  |
| 484886 |  |  |

|          |                   |
|----------|-------------------|
|          | 1m                |
|          | 10                |
| <b>W</b> | 20W               |
|          | Según Controlador |

1.000

ESQUEMA INSTALACIÓN/  
INSTALLATION SCHEME/  
SCHEMA D'INSTALLATION/  
ESQUEMA DE INSTALAÇÃO

+ +

Producto/Product  
Produit/Produto

|        |  |  |
|--------|--|--|
|        |  |  |
| 484879 |  |  |

|          |                   |
|----------|-------------------|
|          | 5m                |
|          | 50                |
| <b>W</b> | 92W               |
|          | Según Controlador |

5.000

ESQUEMA INSTALACIÓN/  
INSTALLATION SCHEME/  
SCHEMA D'INSTALLATION/  
ESQUEMA DE INSTALAÇÃO

+ +

Producto/Product  
Produit/Produto

## Accesorios (NO Incluidos) / Accessoires (NOT Included) / Accessories (NON Inclus)/ Acessórios (NÃO Incluso)

+ INFO PAG. 292

|        |   |
|--------|---|
| 485135 | Controlador Master DMX512<br>1 universo |
| 488457 | Fuente alimentación 60W 24V             |
| 485197 | Conector a fuente alimentación          |
| 484978 | Conector 5 DMX<br>(1 entrada/6 salidas) |
| 485166 | Amplificador señal DMX 3 salidas        |

|        |  |
|--------|--|
| 529037 | Controlador Master DMX512<br>2 universos |
| 488464 | Fuente alimentación 100W 24V             |
| 484916 | Conector T DMX<br>(2 entradas/1 salida)  |
| 484923 | Extensión 25cm DMX                       |

|        |  |
|--------|--|
| 485142 | Controlador Master DMX512<br>8 universos |
| 481687 | Fuente alimentación 150W 24V             |
| 484954 | Conector T DMX<br>(1 entrada/2 salidas)  |
| 484930 | Extensión 1m DMX                         |

|        |   |
|--------|---|
| 485159 | Controlador Master DMX512<br>16 universos |
| 571968 | Fuente alimentación 200W 24V              |
| 484961 | Conector 3 DMX<br>(1 entrada/4 salidas)   |
| 484947 | Extensión 3m DMX                          |



## CONEXIÓN EN SERIE ESQUEMA INSTALACIÓN 1 UNIVERSO

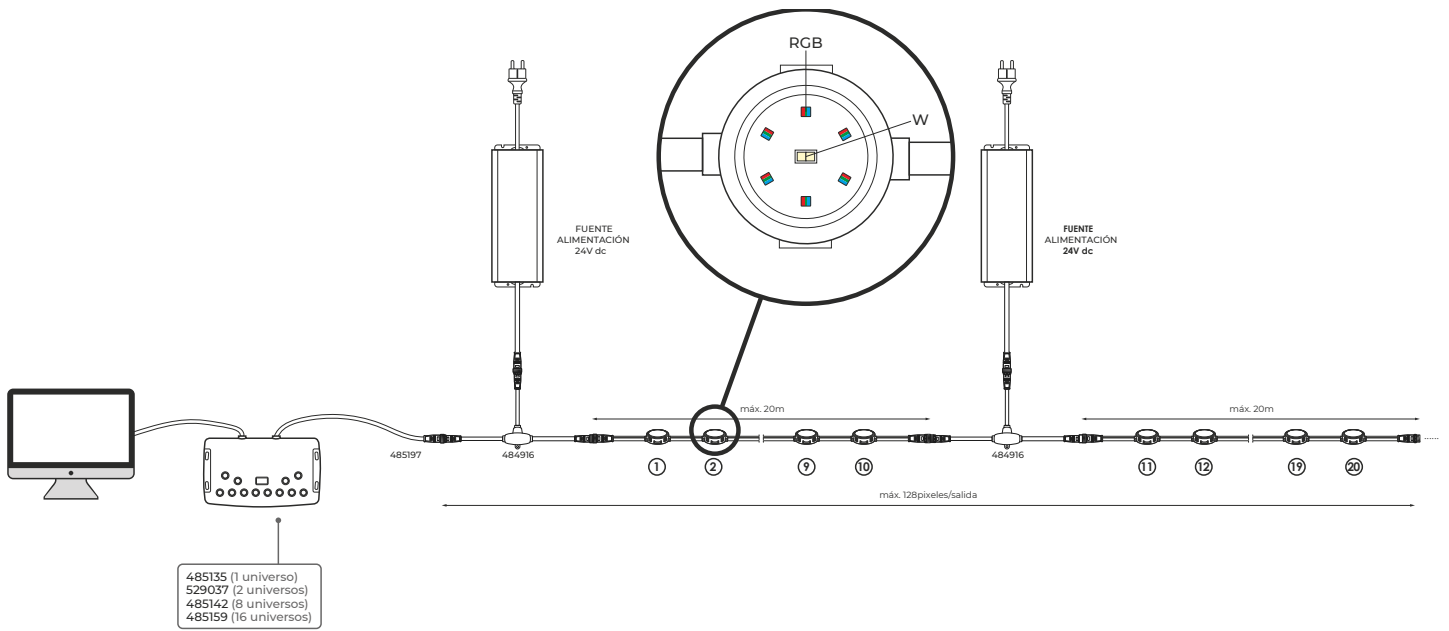

## CONEXIÓN EN PARALELO ESQUEMA INSTALACIÓN 1 UNIVERSO

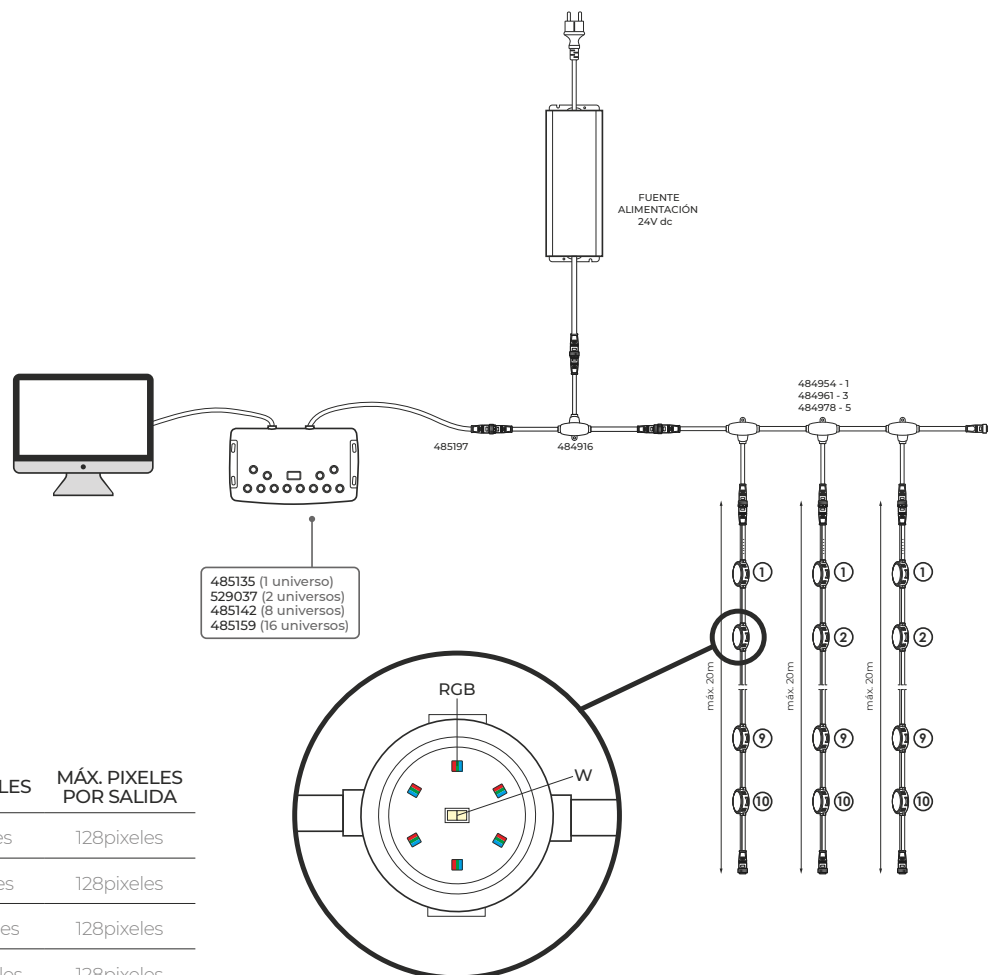

| CÓDIGO CONTROLADOR | UNIVERSOS/SALIDAS | MÁX. PÍXELES  | MÁX. PÍXELES POR SALIDA |
|--------------------|-------------------|---------------|-------------------------|
| 485135             | 1 universo        | 128 píxeles   | 128 píxeles             |
| 529037             | 2 universos       | 256 píxeles   | 128 píxeles             |
| 485142             | 8 universos       | 1.024 píxeles | 128 píxeles             |
| 485159             | 16 universos      | 2.048 píxeles | 128 píxeles             |

# SCREEN PIXELMAX RGB

4x2m

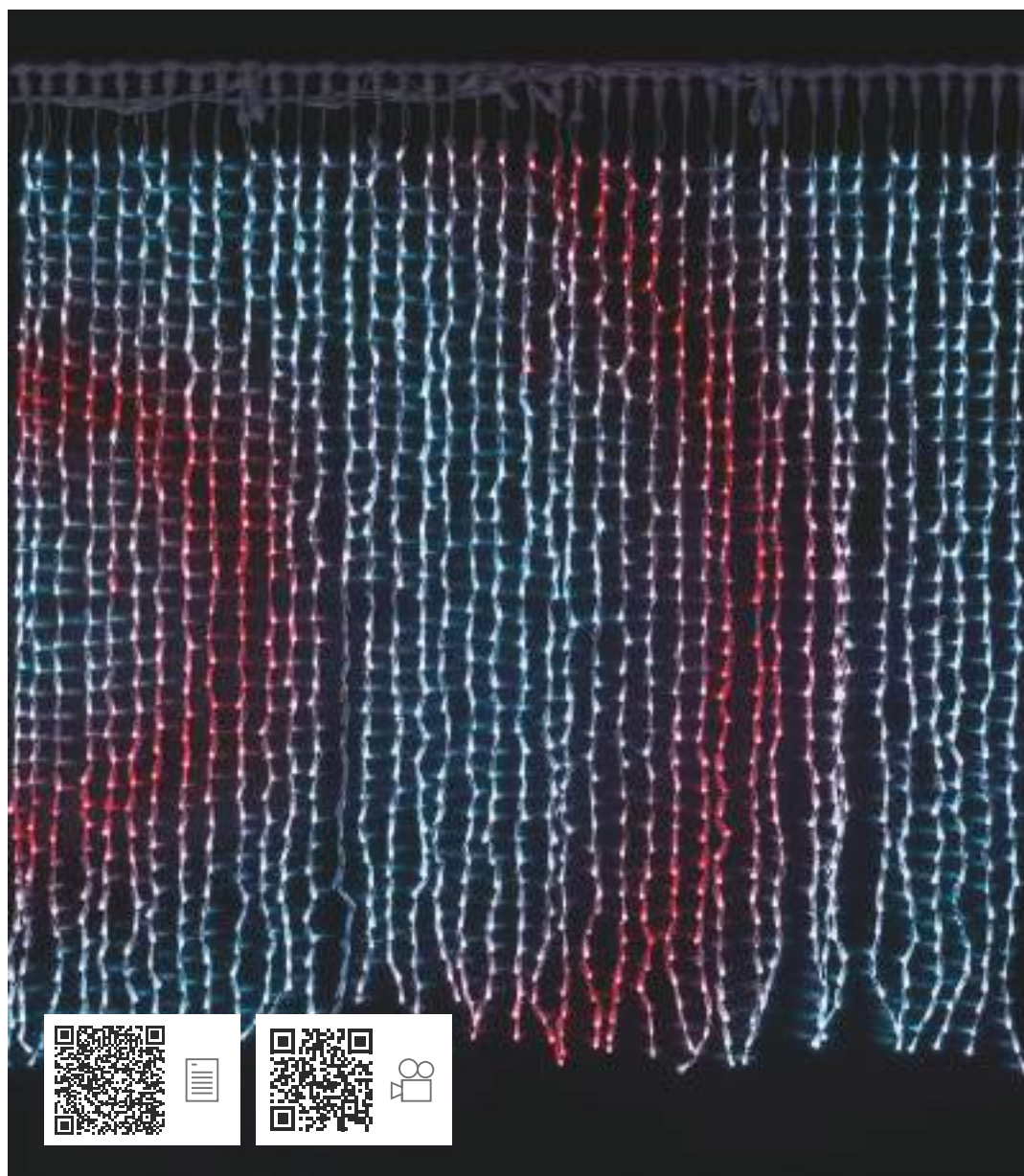

⚡ 66V dc

Hz 50-60Hz

☐ CII

⊙ IP44

⚡ x8 PF-BOX

☐ Controlador esclavo

☐ Controlador master

⊙ 10ud

Ñ/ Cables de alimentación y caja estanca **INCLUIDOS**  
 E/ Power supply cables and watertight box **INCLUDED**  
 F/ Câbles d'alimentation et boîtier étanche **INCLUS**  
 P/ Cabos de alimentação e caixa à prova d'água **INCLUÍDO**

|        |  |  |
|--------|--|--|
|        |  |  |
| 496780 |  |  |

|   |      |
|---|------|
|   | 4x2m |
|   | 80   |
|   | 3200 |
|   | 40   |
| W | 528W |

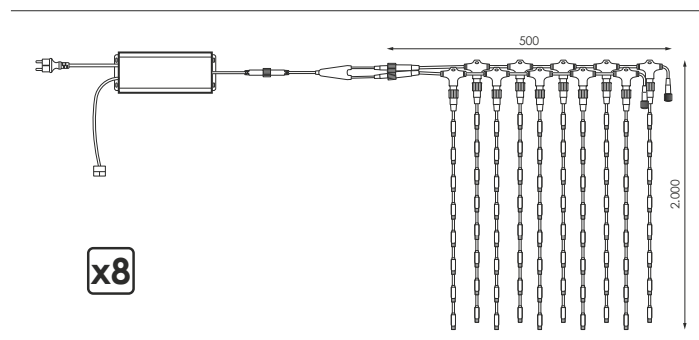

## Información/Information/Information/Informações

Ñ/ Se sirve con animación standard preprogramada.

E/ It is served with pre-programmed standard animation.

F/ Il est servi avec une animation standard préprogrammée.

P/ É servido com animação padrão pré-programada.

Conexión de un tramo 0,5m y PF BOX a controlador esclavo

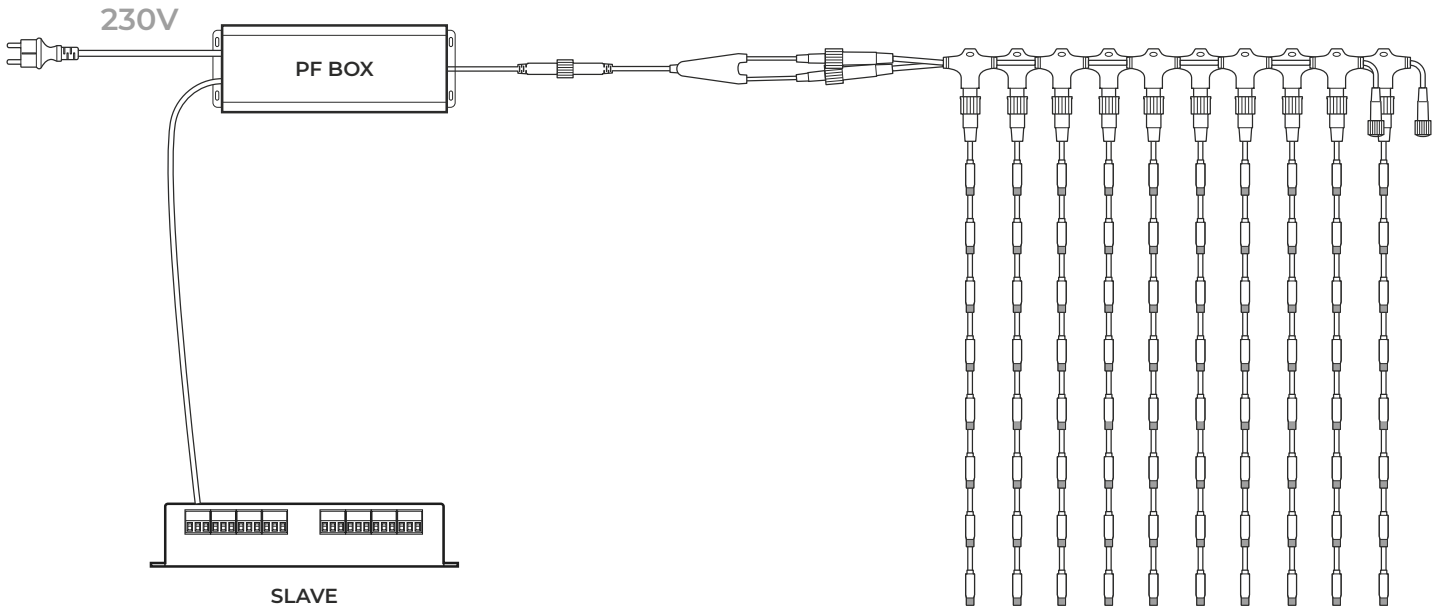

Tramo 4x2m

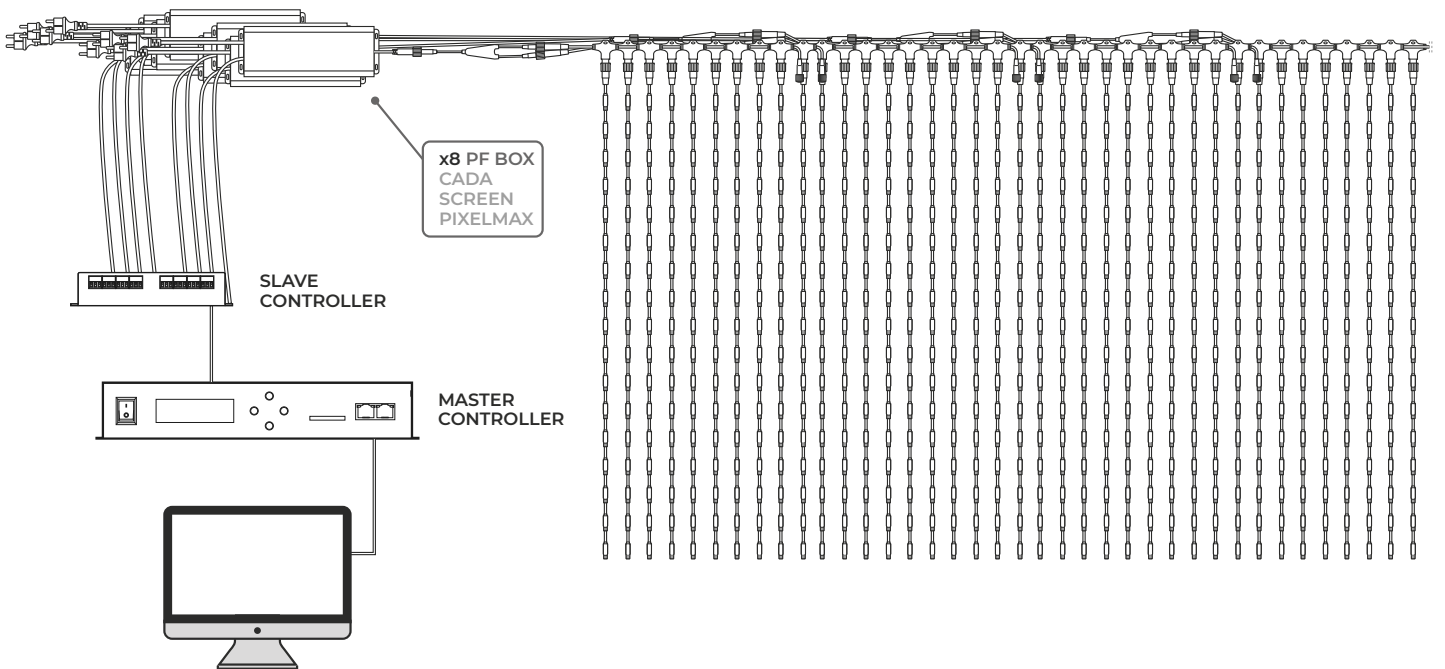

Aviso/Warning/Avertissement/Aviso

Ñ/ Esquema de instalación para Screen PIXELMAX de 4x2m (incluye controlador master y controlador esclavo). **Para ampliación de dimensiones (8x2m, 4x4m,...), consultar bajo pedido con el departamento de sistemas de control.**

E/ Installation diagram for Screen PIXELMAX 4x2m (includes master controller and slave controller). **To enlarge the measurements (8x2m, 4x4m, ...), check on request with the control systems department.**

F/ Écran de veille pour écran PIXELMAX de 4x2m (comprend le contrôleur maître et le contrôleur esclave). **Pour agrandir les mesures (8x2m, 4x4m, ...), vérifiez sur demande auprès du service des systèmes de contrôle.**

P/ Esquema de instalação para tela PIXELMAX de 4x2m (inclui controlador mestre e controlador esclavo). **Para ampliação de dimensões (8x2m, 4x4m, ...), verifique a pedido com o departamento de sistemas de controle.**



# MESH PIXELMAX RGBW

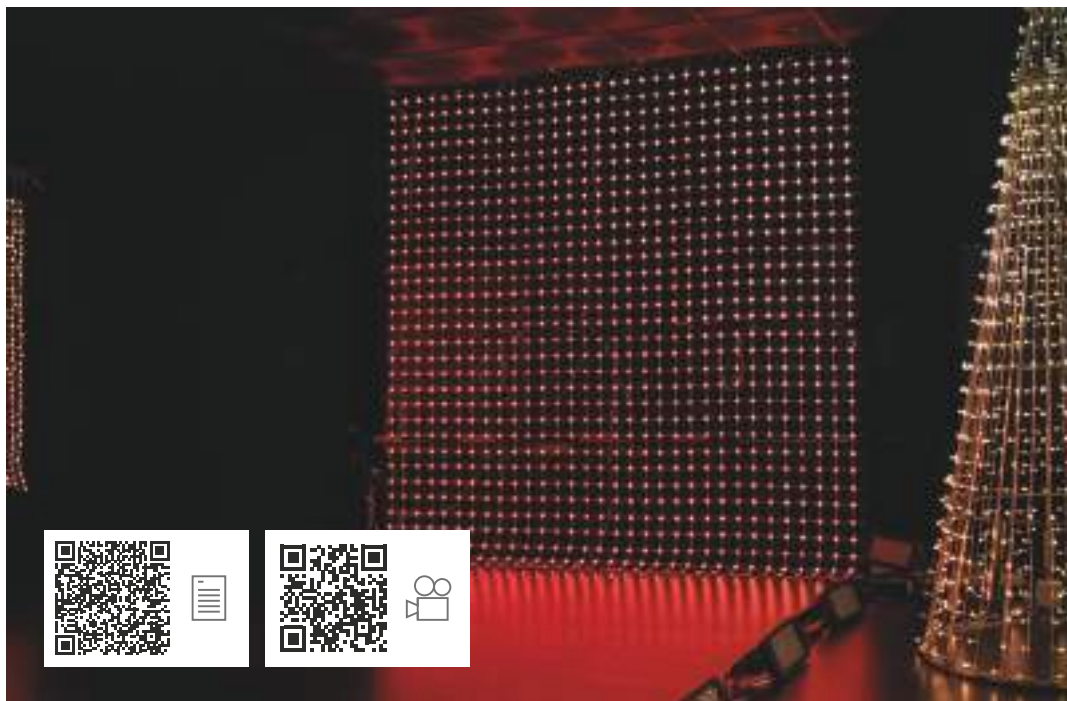

⚡ 24V dc

Hz 50-60Hz

◇ CIII

⊙ IP65

🌡 -20°C~+60 °C

⊗ NO INC.

⊗ NO INC.

⊞ 1ud



566896

|   |          |
|---|----------|
| ↕ | 80x160cm |
| ⊞ | 8        |
| 💡 | 128      |
| ⊞ | 16       |
| W | 192W     |

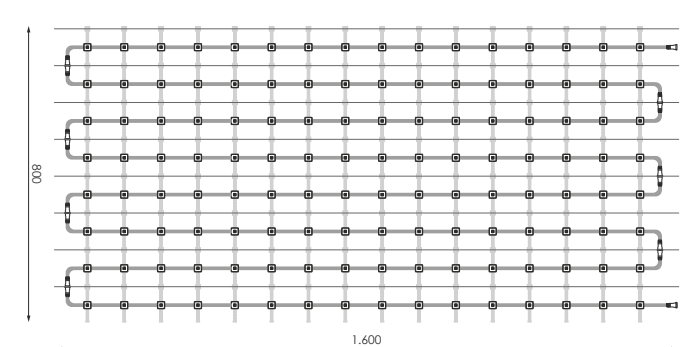

ESQUEMA INSTALACIÓN/  
INSTALLATION SCHEME/  
SCHEMA D'INSTALLATION/  
ESQUEMA DE INSTALAÇÃO



Producto/Product  
Produit/Produto

## Accesorios (NO Incluidos) / Accessoires (NOT Included) / Accessories (NON Inclus) / Acessórios (NÃO Incluso)

+ INFO PAG. 292

|        |   |
|--------|---|
| 485173 | Controlador Master SPI<br>4 salidas/4 universos |
| 571968 | Fuente alimentación 200W 24V                    |
| 570350 | Extensión 1m SPI                                |

|        |   |
|--------|---|
| 485180 | Controlador Master SPI<br>4x2 salidas/8 universos |
| 568982 | Conector a controlador                            |
| 570367 | Extensión 3m SPI                                  |

|        |   |
|--------|---|
| 568968 | Controlador Slave SPI<br>8x4 salidas/32 universos |
| 569996 | Cierre M4 para cable de acero                     |
| 570374 | Extensión 5m SPI                                  |

|        |   |
|--------|---|
| 567992 | Conector T SPI<br>(2 entradas/1 salida) |
| 569989 | Tensor para cable de acero              |
| 570381 | Extensión 10m SPI                       |

## Información/Information/Information/Informações

**Ñ/** Se sirve con animación standard preprogramada.

**E/** It is served with pre-programmed standard animation.

**F/** Il est servi avec une animation standard préprogrammée.

**P/** É servido com animação padrão pré-programada.

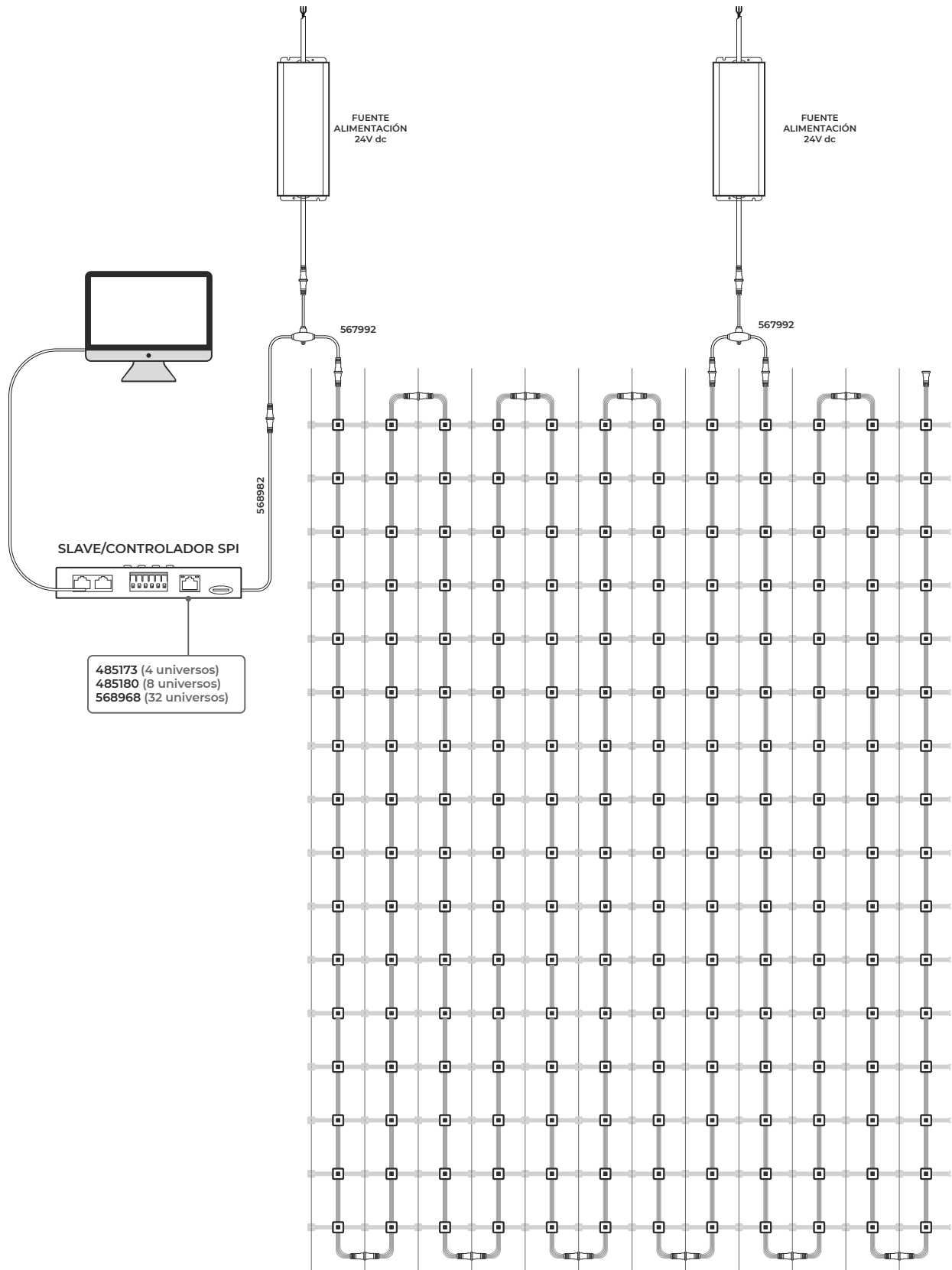

[GRÁFICOS: Unidades en mm/ GRAPHSICS: Units in mm/GRAPHIQUES: Unités en mm/GRÁFICOS: Unidades em mm]

Ñ/ Esquema de instalación para Mesh PIXELMAX. **Para ampliación de dimensiones, consultar bajo pedido con el departamento de sistemas de control.**

E/ Installation diagram for Mesh PIXELMAX. **To enlarge the dimensions, check on request with the control systems department.**

F/ Écran de veille pour Mesh PIXELMAX. **Para ampliación de dimensiones, vérifier sur demande auprès du service des systèmes de contrôle.**

P/ Esquema de instalação para Mesh PIXELMAX. **Para ampliação de dimensões, verifique a pedido com o departamento de sistemas de controle.**

Aviso/Warning/Avertissement/Aviso

# CONTROLADOR

## para productos estáticos

Una manera sencilla de añadir dinamismo a todos nuestros productos estáticos (230V) y crear espacios divertidos y con movimiento.

### CONTROLLER

for static products

A simple way to add dynamism to all our static products (230V) and create fun and moving spaces.

### CONTRÔLEUR

pour les produits statiques

Un moyen simple d'ajouter du dynamisme à tous nos produits statiques (230V) et de créer des espaces amusants et émouvants.

### CONTROLADOR

para produtos estáticos

Uma maneira simples de adicionar dinamismo a todos os nossos produtos estáticos (230V) e criar espaços divertidos e móveis.

### CONTROLADOR

2 canales DMX-TRIAC

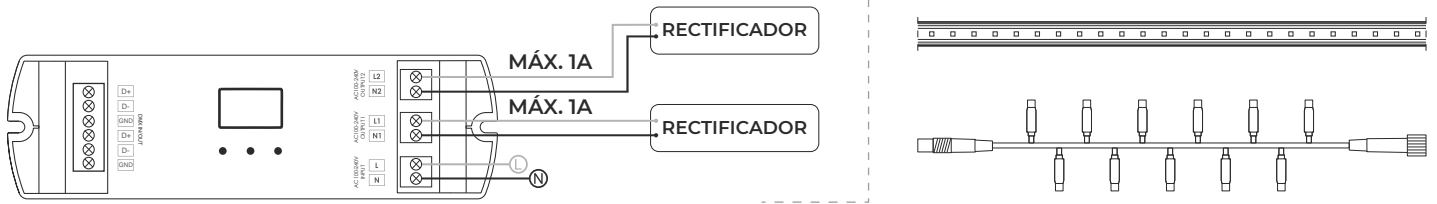

Accesorios (NO Incluidos) / Accessoires (NOT Included) / Accessories (NON Inclus) / Acessórios (NÃO Incluso)

+ INFO PAG. 292

**N** 608633

Controlador DMX-TRIAC 12-36V  
32 programas IP67

529037

Controlador Master DMX512  
2 universos

**N** 614900

Box control DMX-TRIAC 110-240V  
32 programas IP67

485166

Amplificador señal DMX

**N** 608640

Controlador DMX-TRIAC 110-240V  
32 programas IP67

485142

Controlador Master DMX512  
8 universos

490641

Box control 2 salidas

496902

Caja estanca controlador DMX

451154

Controlador DMX-TRIAC (2 canales)

485159

Controlador Master DMX512-SPI  
16 universos

490658

Box control 6 salidas

485135

Controlador Master DMX512  
1 universo

493338

Fuente alimentación 12V 15W

490665

Box control 10 salidas

### Aviso/Warning/Avertissement/Aviso

**N/** Estos productos son IP20 (excepto los box de control) y para instalaciones en exterior es necesaria una caja estanca.

**E/** These products are IP20 (except the control boxes) and for outdoor installations a watertight box is necessary.



**F/** Ces produits sont IP20 (sauf pour les boîtiers de commande) et pour les installations extérieures, un boîtier étanche est requis.

**P/** Esses produtos são IP20 (exceto para caixas de controle) e para instalações externas é necessária uma caixa estanque.





MOTIVO



Calle Alfonso I -  
ZARAGOZA



CALLE







# Accesorios (NO Incluidos)

Accessoires (NOT Included)

Accessories (NON Inclus)

Acessórios (NÃO Incluso)

|  |  | flexiLIGHT<br>Maxibrillo RGB | flexiLIGHT<br>Neon RGB | flexiLIGHT<br>RGBWW | flexiLIGHT<br>RGB | flexiLIGHT<br>CW-WWW | STRING PLUS 100<br>RGBWW | STRING PLUS 100<br>RGB | STRING PLUS 100<br>CW-WWW | SCREENLIGHT<br>RGBWW | ICICLE<br>RGBWW | STRING PLUS 100<br>RGBWW 24V | STRING PLUS 100<br>RGB 24V (Fuente) | STRING PLUS 100<br>CW-WWW 24V | STRING<br>PIXELMAX | DOT DMX<br>PIXELMAX | SCREEN<br>PIXELMAX | MESH<br>PIXELMAX | PRODUCTOS<br>ESTÁTICOS<br>230V |
|--|---|------------------------------|------------------------|---------------------|-------------------|----------------------|--------------------------|------------------------|---------------------------|----------------------|-----------------|------------------------------|-------------------------------------|-------------------------------|--------------------|---------------------|--------------------|------------------|--------------------------------|
|  | 149198  |                              |                        |                     |                   |                      |                          |                        |                           |                      |                 |                              |                                     | •                             |                    |                     |                    |                  |                                |
|  | 193061  |                              |                        |                     |                   |                      |                          |                        |                           |                      |                 |                              |                                     |                               |                    |                     |                    |                  |                                |
|  | 193078  |                              |                        |                     |                   |                      |                          |                        |                           |                      |                 |                              |                                     |                               |                    |                     |                    |                  |                                |
|  | 481687  |                              |                        |                     |                   |                      |                          |                        |                           |                      |                 | •                            | •                                   |                               |                    | •                   |                    |                  |                                |
|  | 484282  |                              |                        |                     |                   |                      |                          |                        |                           |                      |                 |                              |                                     |                               | •                  |                     |                    |                  |                                |
|  | 488440  |                              |                        |                     |                   |                      |                          |                        |                           |                      |                 | •                            | •                                   |                               |                    |                     |                    |                  |                                |
|  | 488457  |                              |                        |                     |                   |                      |                          |                        |                           |                      |                 | •                            | •                                   |                               |                    |                     |                    |                  |                                |
|  | 488464  |                              |                        |                     |                   |                      |                          |                        |                           |                      |                 | •                            | •                                   |                               |                    |                     |                    |                  |                                |
|  | 493338  |                              |                        |                     |                   |                      |                          |                        |                           |                      |                 |                              |                                     |                               |                    |                     |                    |                  | •                              |
|  | 563161  |                              |                        |                     |                   |                      |                          |                        |                           |                      |                 |                              |                                     |                               | •                  |                     |                    |                  |                                |
|  | 571968  |                              |                        |                     |                   |                      |                          |                        |                           |                      |                 | •                            | •                                   |                               |                    | •                   |                    | •                |                                |
|  | 451154  |                              |                        |                     |                   |                      |                          |                        |                           |                      |                 |                              |                                     |                               |                    |                     |                    |                  | •                              |
|  | 454261  |                              |                        |                     | •                 |                      |                          | •                      |                           |                      |                 |                              |                                     |                               |                    |                     |                    |                  |                                |
|  | 472494  |                              |                        |                     |                   |                      |                          |                        |                           |                      |                 |                              |                                     |                               | •                  |                     |                    |                  |                                |
|  | 485135  |                              |                        |                     |                   |                      |                          |                        | •                         |                      |                 |                              | •                                   |                               |                    |                     |                    |                  |                                |
|  | 485142  |                              |                        |                     |                   |                      |                          |                        | •                         |                      |                 |                              | •                                   |                               |                    |                     |                    |                  |                                |
|  | 485159  |                              |                        |                     |                   |                      |                          |                        |                           |                      |                 |                              |                                     |                               | •                  |                     |                    |                  |                                |
|  | 485166  |                              |                        |                     |                   |                      |                          |                        | •                         |                      |                 |                              | •                                   | •                             | •                  | •                   |                    |                  |                                |
|  | 485173  |                              |                        |                     |                   |                      |                          |                        |                           |                      |                 |                              |                                     |                               | •                  |                     |                    | •                |                                |
|  | 485180  |                              |                        |                     |                   |                      |                          |                        |                           |                      |                 |                              |                                     |                               | •                  |                     |                    | •                |                                |
|  | 486262  |                              |                        | •                   |                   |                      |                          | •                      |                           |                      |                 |                              |                                     |                               |                    |                     |                    |                  |                                |
|  | 486279  |                              |                        | •                   |                   |                      |                          | •                      |                           |                      |                 |                              |                                     |                               |                    |                     |                    |                  |                                |
|  | 486309  |                              |                        |                     |                   | •                    |                          |                        | •                         |                      |                 |                              |                                     |                               |                    |                     |                    |                  |                                |
|  | 486316  |                              |                        |                     |                   | •                    |                          |                        | •                         |                      |                 |                              |                                     |                               |                    |                     |                    |                  |                                |
|  | 486323  |                              |                        |                     |                   | •                    |                          |                        | •                         |                      |                 |                              |                                     |                               |                    |                     |                    |                  |                                |
|  | 486330  |                              |                        |                     |                   | •                    |                          |                        | •                         |                      |                 |                              |                                     |                               |                    |                     |                    |                  |                                |
|  | 486422  |                              |                        |                     |                   |                      |                          |                        |                           |                      |                 |                              | •                                   |                               |                    |                     |                    |                  |                                |
|  | 486439  |                              |                        |                     |                   |                      |                          |                        |                           |                      |                 |                              | •                                   |                               |                    |                     |                    |                  |                                |
|  | 486460  |                              |                        |                     |                   |                      |                          |                        |                           |                      |                 |                              |                                     |                               |                    |                     | •                  |                  |                                |
|  | 490191  |                              |                        |                     |                   |                      |                          |                        |                           |                      |                 |                              |                                     |                               |                    |                     |                    |                  |                                |
|  | 490245  |                              |                        |                     |                   |                      |                          |                        |                           |                      |                 |                              |                                     |                               |                    |                     |                    |                  |                                |
|  | 490641  |                              |                        |                     |                   |                      |                          |                        |                           |                      |                 |                              |                                     |                               |                    |                     |                    |                  | •                              |
|  | 490658  |                              |                        |                     |                   |                      |                          |                        |                           |                      |                 |                              |                                     |                               |                    |                     |                    |                  | •                              |
|  | 490665  |                              |                        |                     |                   |                      |                          |                        |                           |                      |                 |                              |                                     |                               |                    |                     |                    |                  | •                              |
|  | 496445  |                              |                        |                     |                   |                      |                          |                        |                           |                      |                 |                              |                                     |                               | •                  |                     |                    |                  |                                |
|  | 496902  |                              |                        |                     | •                 | •                    |                          |                        |                           |                      |                 |                              |                                     |                               |                    |                     |                    |                  | •                              |
|  | 514491  |                              | •                      |                     |                   |                      | •                        |                        |                           | •                    | •               |                              |                                     |                               |                    |                     |                    |                  | •                              |
|  | 514507  |                              | •                      |                     |                   |                      | •                        |                        |                           | •                    | •               |                              |                                     |                               |                    |                     |                    |                  | •                              |
|  | 514514  |                              | •                      |                     |                   |                      | •                        |                        |                           | •                    | •               |                              |                                     |                               |                    |                     |                    |                  | •                              |
|  | 529037  |                              |                        |                     |                   |                      |                          |                        |                           |                      |                 |                              |                                     |                               |                    | •                   |                    |                  | •                              |
|  | 571845  |                              |                        |                     | •                 |                      |                          | •                      |                           |                      |                 |                              |                                     |                               |                    |                     |                    |                  |                                |
|  | 566520  |                              | •                      |                     |                   |                      | •                        |                        |                           | •                    | •               |                              |                                     |                               |                    |                     |                    |                  |                                |

|  |  | flexiLIGHT<br>Maxibrillo RGB | flexiLIGHT<br>Neon RGB | flexiLIGHT<br>RGBWW | flexiLIGHT<br>RGB | flexiLIGHT<br>CW-WW | STRING [PLUS] 100<br>RGBWW | STRING [PLUS] 100<br>RGB | STRING [PLUS] 100<br>CW-WW | SCREENLIGHT<br>RGBWW | ICICLE#<br>RGBWW | STRING [PLUS] 100<br>RGBWW 24V | STRING [PLUS] 100<br>RGB 24V (Fuente) | STRING [PLUS] 100<br>CW-WW 24V | STRING<br>PIXELMAX | DOT DMX<br>PIXELMAX | SCREEN<br>PIXELMAX | MESH<br>PIXELMAX | PRODUCTOS<br>ESTÁTICOS<br>230V |
|--|---|------------------------------|------------------------|---------------------|-------------------|---------------------|----------------------------|--------------------------|----------------------------|----------------------|------------------|--------------------------------|---------------------------------------|--------------------------------|--------------------|---------------------|--------------------|------------------|--------------------------------|
|  | 567992  |                              |                        |                     |                   |                     |                            |                          |                            |                      |                  |                                |                                       |                                |                    |                     |                    |                  |                                |
|  | 568968  |                              |                        |                     |                   |                     |                            |                          |                            |                      |                  |                                |                                       |                                |                    |                     |                    |                  |                                |
|  | 588874  |                              |                        |                     |                   |                     |                            |                          |                            |                      |                  |                                |                                       |                                |                    |                     |                    |                  |                                |
|  | 588881  |                              |                        |                     |                   |                     |                            |                          |                            |                      |                  |                                |                                       |                                |                    |                     |                    |                  |                                |
|  | 599894  |                              |                        |                     |                   |                     |                            |                          |                            |                      |                  |                                |                                       |                                |                    |                     |                    |                  |                                |
|    | 599917  |                              |                        |                     |                   |                     |                            |                          |                            |                      |                  |                                |                                       |                                |                    |                     |                    |                  |                                |
|  | 600705  |                              |                        |                     |                   |                     |                            |                          |                            |                      |                  |                                |                                       |                                |                    |                     |                    |                  |                                |
|  | 608633  |                              |                        |                     |                   |                     |                            |                          |                            |                      |                  |                                |                                       |                                |                    |                     |                    |                  |                                |
|  | 608640  |                              |                        |                     |                   |                     |                            |                          |                            |                      |                  |                                |                                       |                                |                    |                     |                    |                  |                                |
|  | 614900  |                              |                        |                     |                   |                     |                            |                          |                            |                      |                  |                                |                                       |                                |                    |                     |                    |                  |                                |
|  | 628389  |                              |                        |                     |                   |                     |                            |                          |                            |                      |                  |                                |                                       |                                |                    |                     |                    |                  |                                |
|  | 192323  |                              |                        |                     |                   |                     |                            |                          |                            |                      |                  |                                |                                       |                                |                    |                     |                    |                  |                                |
|  | 192347  |                              |                        |                     |                   |                     |                            |                          |                            |                      |                  |                                |                                       |                                |                    |                     |                    |                  |                                |
|  | 192354  |                              |                        |                     |                   |                     |                            |                          |                            |                      |                  |                                |                                       |                                |                    |                     |                    |                  |                                |
|  | 192361  |                              |                        |                     |                   |                     |                            |                          |                            |                      |                  |                                |                                       |                                |                    |                     |                    |                  |                                |
|  | 192378  |                              |                        |                     |                   |                     |                            |                          |                            |                      |                  |                                |                                       |                                |                    |                     |                    |                  |                                |
|  | 192385  |                              |                        |                     |                   |                     |                            |                          |                            |                      |                  |                                |                                       |                                |                    |                     |                    |                  |                                |
|  | 192392  |                              |                        |                     |                   |                     |                            |                          |                            |                      |                  |                                |                                       |                                |                    |                     |                    |                  |                                |
|  | 192408  |                              |                        |                     |                   |                     |                            |                          |                            |                      |                  |                                |                                       |                                |                    |                     |                    |                  |                                |
|  | 192415  |                              |                        |                     |                   |                     |                            |                          |                            |                      |                  |                                |                                       |                                |                    |                     |                    |                  |                                |
|  | 192422  |                              |                        |                     |                   |                     |                            |                          |                            |                      |                  |                                |                                       |                                |                    |                     |                    |                  |                                |
|  | 192439  |                              |                        |                     |                   |                     |                            |                          |                            |                      |                  |                                |                                       |                                |                    |                     |                    |                  |                                |
|  | 192446  |                              |                        |                     |                   |                     |                            |                          |                            |                      |                  |                                |                                       |                                |                    |                     |                    |                  |                                |
|  | 192453  |                              |                        |                     |                   |                     |                            |                          |                            |                      |                  |                                |                                       |                                |                    |                     |                    |                  |                                |
|  | 192477  |                              |                        |                     |                   |                     |                            |                          |                            |                      |                  |                                |                                       |                                |                    |                     |                    |                  |                                |
|  | 192484  |                              |                        |                     |                   |                     |                            |                          |                            |                      |                  |                                |                                       |                                |                    |                     |                    |                  |                                |
|  | 192491  |                              |                        |                     |                   |                     |                            |                          |                            |                      |                  |                                |                                       |                                |                    |                     |                    |                  |                                |
|  | 388368  |                              |                        |                     |                   |                     |                            |                          |                            |                      |                  |                                |                                       |                                |                    |                     |                    |                  |                                |
|  | 388375  |                              |                        |                     |                   |                     |                            |                          |                            |                      |                  |                                |                                       |                                |                    |                     |                    |                  |                                |
|  | 388382  |                              |                        |                     |                   |                     |                            |                          |                            |                      |                  |                                |                                       |                                |                    |                     |                    |                  |                                |
|  | 388399  |                              |                        |                     |                   |                     |                            |                          |                            |                      |                  |                                |                                       |                                |                    |                     |                    |                  |                                |
|  | 388498  |                              |                        |                     |                   |                     |                            |                          |                            |                      |                  |                                |                                       |                                |                    |                     |                    |                  |                                |
|  | 388504  |                              |                        |                     |                   |                     |                            |                          |                            |                      |                  |                                |                                       |                                |                    |                     |                    |                  |                                |
|  | 391498  |                              |                        |                     |                   |                     |                            |                          |                            |                      |                  |                                |                                       |                                |                    |                     |                    |                  |                                |
|  | 391504  |                              |                        |                     |                   |                     |                            |                          |                            |                      |                  |                                |                                       |                                |                    |                     |                    |                  |                                |
|  | 391535  |                              |                        |                     |                   |                     |                            |                          |                            |                      |                  |                                |                                       |                                |                    |                     |                    |                  |                                |
|  | 481700  |                              |                        |                     |                   |                     |                            |                          |                            |                      |                  |                                |                                       |                                |                    |                     |                    |                  |                                |
|  | 481717  |                              |                        |                     |                   |                     |                            |                          |                            |                      |                  |                                |                                       |                                |                    |                     |                    |                  |                                |
|  | 481724  |                              |                        |                     |                   |                     |                            |                          |                            |                      |                  |                                |                                       |                                |                    |                     |                    |                  |                                |
|  | 484299  |                              |                        |                     |                   |                     |                            |                          |                            |                      |                  |                                |                                       |                                |                    |                     |                    |                  |                                |
|  | 484305  |                              |                        |                     |                   |                     |                            |                          |                            |                      |                  |                                |                                       |                                |                    |                     |                    |                  |                                |
|  | 484312  |                              |                        |                     |                   |                     |                            |                          |                            |                      |                  |                                |                                       |                                |                    |                     |                    |                  |                                |
|  | 484312  |                              |                        |                     |                   |                     |                            |                          |                            |                      |                  |                                |                                       |                                |                    |                     |                    |                  |                                |
|  | 484329  |                              |                        |                     |                   |                     |                            |                          |                            |                      |                  |                                |                                       |                                |                    |                     |                    |                  |                                |
|  | 484336  |                              |                        |                     |                   |                     |                            |                          |                            |                      |                  |                                |                                       |                                |                    |                     |                    |                  |                                |
|  | 484343  |                              |                        |                     |                   |                     |                            |                          |                            |                      |                  |                                |                                       |                                |                    |                     |                    |                  |                                |
|  | 484350  |                              |                        |                     |                   |                     |                            |                          |                            |                      |                  |                                |                                       |                                |                    |                     |                    |                  |                                |
|  | 484367  |                              |                        |                     |                   |                     |                            |                          |                            |                      |                  |                                |                                       |                                |                    |                     |                    |                  |                                |
|  | 484916  |                              |                        |                     |                   |                     |                            |                          |                            |                      |                  |                                |                                       |                                |                    |                     |                    |                  |                                |
|  | 484923  |                              |                        |                     |                   |                     |                            |                          |                            |                      |                  |                                |                                       |                                |                    |                     |                    |                  |                                |
|  | 484930  |                              |                        |                     |                   |                     |                            |                          |                            |                      |                  |                                |                                       |                                |                    |                     |                    |                  |                                |
|  | 484947  |                              |                        |                     |                   |                     |                            |                          |                            |                      |                  |                                |                                       |                                |                    |                     |                    |                  |                                |
|  | 484954  |                              |                        |                     |                   |                     |                            |                          |                            |                      |                  |                                |                                       |                                |                    |                     |                    |                  |                                |
|  | 484961  |                              |                        |                     |                   |                     |                            |                          |                            |                      |                  |                                |                                       |                                |                    |                     |                    |                  |                                |
|  | 484978  |                              |                        |                     |                   |                     |                            |                          |                            |                      |                  |                                |                                       |                                |                    |                     |                    |                  |                                |



|   | flexiLIGHT<br>Maxibrillo RGB | flexiLIGHT<br>Neon RGB | flexiLIGHT<br>RGBWW | flexiLIGHT<br>RGB | flexiLIGHT<br>CW-WWW | STRING [PLUS] 100<br>RGBWW | STRING [PLUS] 100<br>RGB | STRING [PLUS] 100<br>CW-WWW | SCREENLIGHT<br>RGBWW | ICICLE#<br>RGBWW | STRING [PLUS] 100<br>RGBWW 24V | STRING [PLUS] 100<br>RGB 24V (Fuente) | STRING [PLUS] 100<br>CW-WWW 24V | STRING<br>PIXELMAX | DOT DMX<br>PIXELMAX | SCREEN<br>PIXELMAX | MESH<br>PIXELMAX | PRODUCTOS<br>ESTÁTICOS<br>230V |
|---|------------------------------|------------------------|---------------------|-------------------|----------------------|----------------------------|--------------------------|-----------------------------|----------------------|------------------|--------------------------------|---------------------------------------|---------------------------------|--------------------|---------------------|--------------------|------------------|--------------------------------|
|   | 485197                       |                        |                     |                   |                      |                            |                          |                             |                      |                  |                                |                                       |                                 |                    |                     |                    |                  |                                |
|   | 490207                       |                        |                     |                   |                      |                            |                          |                             |                      |                  |                                |                                       |                                 |                    |                     |                    |                  |                                |
|   | 490214                       |                        |                     |                   |                      |                            |                          |                             |                      |                  |                                |                                       |                                 |                    |                     |                    |                  |                                |
|   | 490221                       |                        |                     |                   |                      |                            |                          |                             |                      |                  |                                |                                       |                                 |                    |                     |                    |                  |                                |
|   | 490740                       |                        |                     |                   |                      |                            |                          | •                           |                      |                  |                                | •                                     | •                               | •                  | •                   | •                  |                  | •                              |
|   | 496735                       |                        |                     |                   |                      |                            |                          |                             |                      |                  |                                |                                       |                                 | •                  | •                   |                    |                  |                                |
|   | 518154                       |                        |                     |                   |                      |                            |                          |                             |                      |                  |                                |                                       |                                 | •                  | •                   |                    |                  |                                |
|   | 518161                       |                        |                     |                   |                      |                            |                          |                             |                      |                  |                                |                                       |                                 | •                  | •                   |                    |                  |                                |
|   | 518178                       |                        |                     |                   |                      |                            |                          |                             |                      |                  |                                |                                       |                                 | •                  | •                   |                    |                  |                                |
|   | 551779                       |                        |                     |                   |                      |                            |                          | •                           |                      |                  |                                | •                                     | •                               | •                  | •                   |                    |                  |                                |
|   | 567992                       |                        |                     |                   |                      |                            |                          |                             |                      |                  |                                | •                                     | •                               | •                  | •                   |                    |                  |                                |
|   | 568982                       |                        |                     |                   |                      |                            |                          |                             |                      |                  |                                |                                       |                                 |                    |                     |                    | •                | •                              |
| Ⓒ | 569989                       |                        |                     |                   |                      |                            |                          |                             |                      |                  |                                |                                       |                                 |                    |                     |                    | •                | •                              |
|   | 569996                       |                        |                     |                   |                      |                            |                          |                             |                      |                  |                                |                                       |                                 |                    |                     |                    | •                | •                              |
|   | 580335                       |                        |                     |                   |                      |                            |                          |                             |                      |                  |                                |                                       |                                 | •                  | •                   |                    |                  |                                |
|   | 580342                       |                        |                     |                   |                      |                            |                          |                             |                      |                  |                                |                                       |                                 | •                  | •                   |                    |                  |                                |
|   | 580359                       |                        |                     |                   |                      |                            |                          |                             |                      |                  |                                |                                       |                                 | •                  | •                   |                    |                  |                                |
|   | 600958                       |                        | •                   |                   |                      |                            |                          |                             |                      |                  |                                |                                       |                                 |                    |                     |                    |                  |                                |
|   | 600972                       | •                      |                     |                   |                      |                            |                          |                             |                      |                  |                                |                                       |                                 |                    |                     |                    |                  |                                |
|   | 619752                       |                        | •                   |                   |                      |                            |                          |                             |                      |                  |                                |                                       |                                 |                    |                     |                    |                  |                                |
|   | 619769                       | •                      |                     |                   |                      |                            |                          |                             |                      |                  |                                |                                       |                                 |                    |                     |                    |                  |                                |
|   | 971140                       |                        |                     |                   |                      |                            |                          |                             |                      |                  |                                | •                                     |                                 |                    |                     |                    |                  |                                |
|   | 971188                       |                        |                     |                   |                      |                            |                          |                             |                      |                  |                                | •                                     |                                 |                    |                     |                    |                  |                                |
|   | 971195                       |                        |                     |                   |                      |                            |                          |                             |                      |                  |                                | •                                     |                                 |                    |                     |                    |                  |                                |
|   | 971201                       |                        |                     |                   |                      |                            |                          |                             |                      |                  |                                | •                                     |                                 |                    |                     |                    |                  |                                |
|   | 971218                       |                        |                     |                   |                      |                            |                          |                             |                      |                  |                                | •                                     |                                 |                    |                     |                    |                  |                                |
| ⊗ | 600941                       |                        | •                   |                   |                      |                            |                          |                             |                      |                  |                                |                                       |                                 |                    |                     |                    |                  |                                |
|   | 600965                       | •                      |                     |                   |                      |                            |                          |                             |                      |                  |                                |                                       |                                 |                    |                     |                    |                  |                                |

### CONTROLADOR FLEXILIGHT MAXIBRILLO RGB CON MANDO

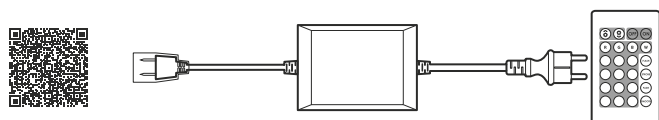

W

599917

230V

IP44

Máx. 50m en línea

### EXTENSIÓN FLEXILIGHT MAXIBRILLO RGB

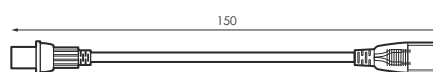

N 619769

15Cm



### EMPALME ESTANCO MAXIBRILLO

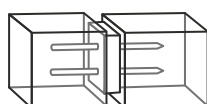

600972



Transparente

### TAPA FINAL MAXIBRILLO

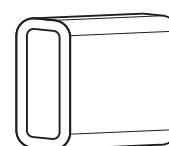

600965



Transparente

CONTROLADOR FLEXILIGHT DOUBLE NEON RGB CON MANDO

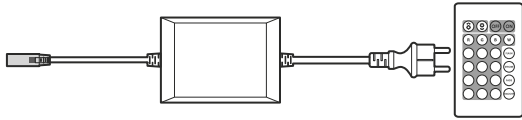

|        |      |      |                   |
|--------|------|------|-------------------|
|        |      |      | <b>W</b>          |
| 599894 | 230V | IP44 | Máx. 50m en línea |

EXTENSIÓN FLEXILIGHT DOUBLE NEON RGB

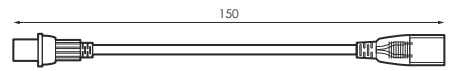

|                 |      |  |
|-----------------|------|--|
| <b>N 619752</b> | 15Cm |  |
|-----------------|------|--|

EMPALME DOUBLE NEON

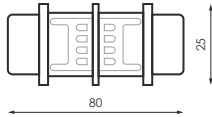

|        |           |        |
|--------|-----------|--------|
| 600958 | <b>Bl</b> | Blanco |
|--------|-----------|--------|

TAPA FINAL DOUBLE NEON

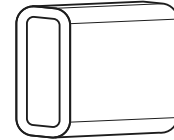

|        |          |              |
|--------|----------|--------------|
| 600941 | <b>T</b> | Transparente |
|--------|----------|--------------|

CONTROLADOR RGBWW CON MANDO

FLEXILIGHT-STRING PLUS-SCREENLIGHT-ICICLE

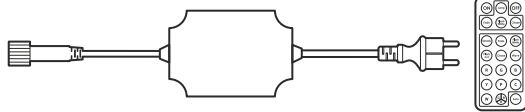

|        |      |      |   |
|--------|------|------|---|
|        |      |      | <b>W</b>  |
| 514514 | 230V | IP55 | Paralelo: Máx. 4.000leds<br>Serie: Máx. 3.600leds |

Efecto memoria  
Memory effect  
Effet mémoire  
Efeito de memória

CONTROLADOR POWER LINE RGBWW

FLEXILIGHT-STRING PLUS-SCREENLIGHT-ICICLE

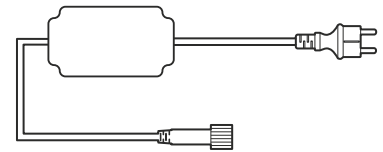

|        |      |      |   |
|--------|------|------|---|
|        |      |      | <b>W</b>  |
| 514507 | 230V | IP55 | Paralelo: Máx. 4.000leds<br>Serie: Máx. 3.600leds |

Sincronización coordinada mediante una línea eléctrica.Cambio secuencial cada 15seg.  
Coordinated synchronization through an electrical panel. Sequential change every 15sec.  
Synchronisation coordonnée via un tableau électrique.Changement séquentiel toutes les 15s.  
Sincronização coordenada através de um painel elétrico. Mudança sequencial a cada 15seg.

CONTROLADOR/PASARELA DMX RGBWW

FLEXILIGHT-STRING PLUS-SCREENLIGHT-ICICLE

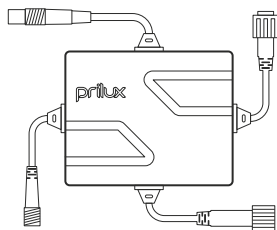

|        |      |      |   |
|--------|------|------|---|
|        |      |      | <b>W</b>  |
| 514491 | 230V | IP55 | Paralelo: Máx. 4.000leds<br>Serie: Máx. 3.600leds |

Cambio secuencial cada 15seg. si no recibe señal DMX.  
Sequential change every 15sec. if you do not receive DMX signal.  
Changement séquentiel toutes les 15 secondes. si vous ne recevez pas de signal DMX.  
Mudança sequencial a cada 15 seg. se você não receber sinal DMX.

SINCRONIZADOR GPS RGBWW

FLEXILIGHT-STRING PLUS-SCREENLIGHT-ICICLE

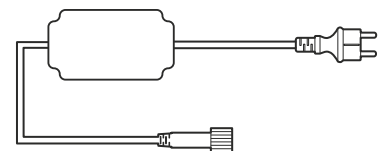

|        |      |      |  |
|--------|------|------|--|
|        |      |      | <b>W</b>   |
| 566520 | 230V | IP55 | Paralelo: Máx. 4.000leds<br>Serie: Máx. 3.600leds<br>Max. 100m/línea |

Sincronización mediante satélite GPS. Solo uso exterior. Cambio secuencial cada 15seg.  
GPS satellite synchronization. Only outside use. Sequential change every 15sec.  
Synchronisation satellite GPS. Seulement utilisation à l'extérieur. Changement séquentiel toutes les 15s.  
Sincronização por satélite GPS. Apenas fora de uso. Mudança sequencial a cada 15seg.

[GRÁFICOS: Unidades en mm/ GRAPHSICS: Units in mm/ GRÁFICOS: Unidades em mm/GRÁFICOS: Unidades em mm]

CONTROLADOR RGB CON MANDO

FLEXILIGHT-STRING PLUS

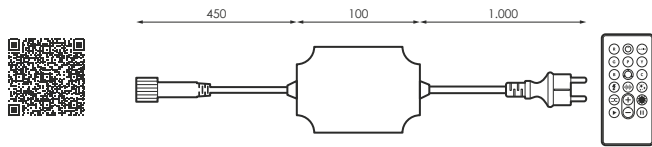

571845



230V



IP55

W

Máx. 2.000leds

Efecto memoria  
Memory effect  
Effet mémoire  
Efeito de memória

CONTROLADOR RGB CON MANDO

FLEXILIGHT-STRING PLUS

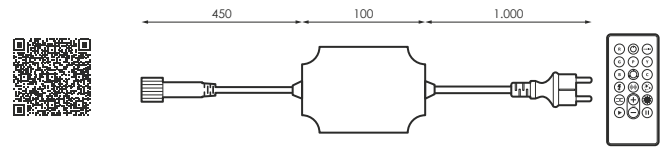

600705



230V



IP55

W

Paralelo: Máx. 4.000leds  
Serie: Máx. 3.600leds

Efecto memoria  
Memory effect  
Effet mémoire  
Efeito de memória

CONTROLADOR POWER LINE RGB

FLEXILIGHT-STRING PLUS

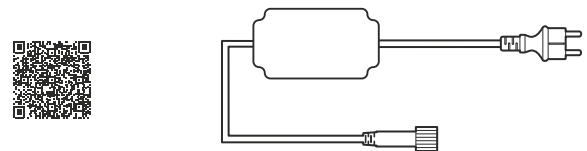

486262



230V



IP55

W

Max. 2.000leds

Sincronización coordinada mediante una línea eléctrica. Cambio secuencial cada 15seg.  
Coordinated synchronization through an electrical panel. Sequential change every 15sec.  
Synchronisation coordonnée via un tableau électrique. Changement séquentiel toutes les 15s.  
Sincronização coordenada através de um painel elétrico. Mudança sequencial a cada 15seg.

CONTROLADOR/PASARELA DMX RGB

FLEXILIGHT-STRING PLUS

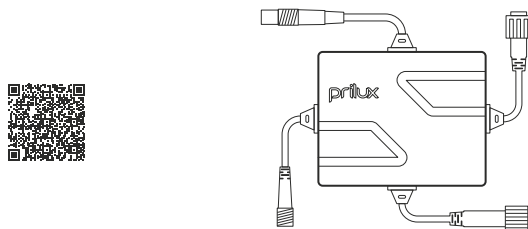

486279



230V



IP55

W

Max. 2.000leds

Cambio secuencial cada 15seg. si no recibe señal DMX.  
Sequential change every 15sec. if you do not receive DMX signal.  
Changement séquentiel toutes les 15 secondes. si vous ne recevez pas de signal DMX.  
Mudança sequencial a cada 15 seg. se você não receber sinal DMX.

SINCRONIZADOR GPS RGB

FLEXILIGHT-STRING PLUS

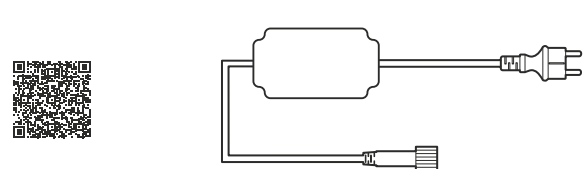

454261



230V



IP55

W

Max. 2.000leds

Sincronización mediante satélite GPS. Solo uso exterior. Cambio secuencial cada 15seg.  
GPS satellite synchronization. Only outside use. Sequential change every 15sec.  
Synchronisation satellite GPS. Seulement utilisation à l'extérieur. Changement séquentiel toutes les 15s.  
Sincronização por satélite GPS. Apenas fora de uso. Mudança sequencial a cada 15seg.



CONTROLADOR CW-WW CON MANDO

FLEXILIGHT-STRING PLUS

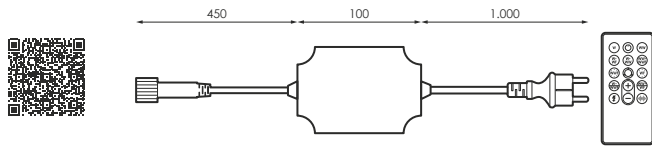

486309



230V



IP55

W

Max. 2.000leds

Efecto memoria  
Memory effect  
Effet mémoire  
Efeito de memória

CONTROLADOR CW-WW CON MANDO

STRING PLUS

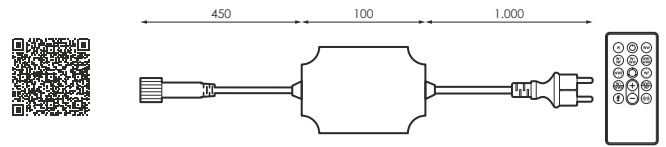

N 628389



230V



IP55

W

Max. 2.000leds

Efecto memoria  
Memory effect  
Effet mémoire  
Efeito de memória

CONTROLADOR POWER LINE CW-WW

FLEXILIGHT-STRING PLUS

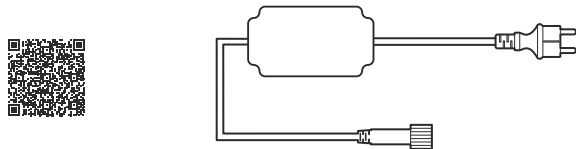

486323



230V



IP55

W

Max. 2.000leds

Sincronización coordinada mediante una línea eléctrica. Cambio secuencial cada 15seg.  
Coordinated synchronization through an electrical panel. Sequential change every 15sec.  
Synchronisation coordonnée via un tableau électrique. Changement séquentiel toutes les 15s.  
Sincronização coordenada através de um painel elétrico. Mudança sequencial a cada 15seg.

SINCRONIZADOR GPS CW-WW

FLEXILIGHT-STRING PLUS

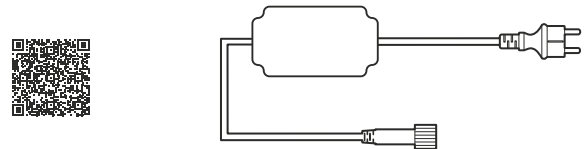

486316



230V



IP55

W

Max. 2.000leds

Sincronización mediante satélite GPS. Solo uso exterior. Cambio secuencial cada 15seg.  
GPS satellite synchronization. Only outside use. Sequential change every 15sec.  
Synchronisation satellite GPS. Seulement utilisation à l'extérieur. Changement séquentiel toutes les 15s.  
Sincronização por satélite GPS. Apenas fora de uso. Mudança sequencial a cada 15seg.

CONTROLADOR/PASARELA DMX CW-WW

FLEXILIGHT-STRING PLUS

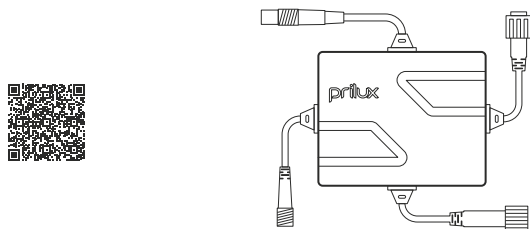

486330



230V



IP55

W

Max. 2.000leds

Cambio secuencial cada 15seg. si no recibe señal DMX.  
Sequential change every 15sec. if you do not receive DMX signal.  
Changement séquentiel toutes les 15 secondes. si vous ne recevez pas de signal DMX.  
Mudança sequencial a cada 15 seg. se você não receber sinal DMX.

CONTROLADOR RGB 24V CON MANDO

STRING PLUS

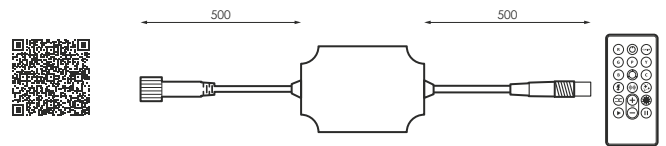

588881



24V



IP55

W

Paralelo: Máx. 850leds  
Serie: Máx. 500leds

Efecto memoria  
Memory effect  
Effet mémoire  
Efeito de memória

CONTROLADOR CW-WW 24V CON MANDO

STRING PLUS

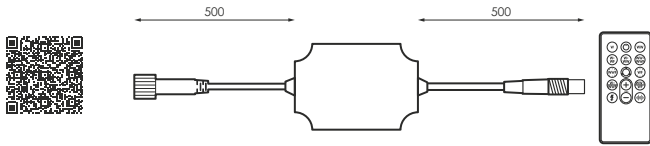

|        |     |      |              |
|--------|-----|------|--------------|
|        |     |      | <b>W</b>     |
| 486422 | 24V | IP55 | Max. 400leds |

Efecto memoria  
Memory effect  
Effet mémoire  
Efeito de memória

CONTROLADOR POWER LINE CW-WW 24V

STRING PLUS

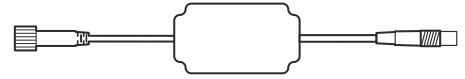

|        |     |      |              |
|--------|-----|------|--------------|
|        |     |      | <b>W</b>     |
| 486439 | 24V | IP55 | Max. 400leds |

Sincronización coordinada mediante una línea eléctrica. Cambio secuencial cada 15seg.  
Coordinated synchronization through an electrical panel. Sequential change every 15sec.  
Synchronisation coordonnée via un tableau électrique. Change-ment séquentiel toutes les 15s.  
Sincronização coordenada através de um painel elétrico. Mudança sequencial a cada 15seg.

CONTROLADOR RGBWW 24V CON MANDO

STRING PLUS

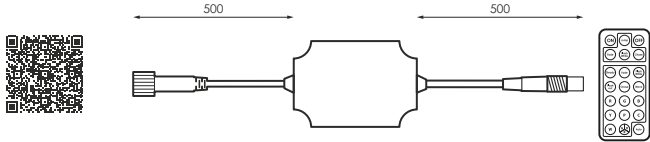

|        |     |      |   |
|--------|-----|------|---|
|        |     |      | <b>W</b>                                      |
| 588874 | 24V | IP55 | Paralelo: Máx. 850leds<br>Serie: Máx. 500leds |

Efecto memoria  
Memory effect  
Effet mémoire  
Efeito de memória

FUENTE ALIMENTACIÓN 12V

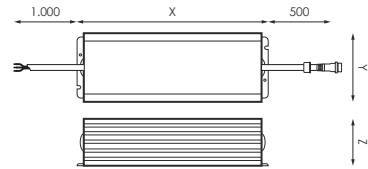

|  |  |  |          |  |
|--|--|--|----------|--|
|  |  |  | <b>W</b> |  |
|--|--|--|----------|--|

|        |     |      |      |                 |           |
|--------|-----|------|------|-----------------|-----------|
| 484282 | 12V | IP66 | 60W  | 195 x 46 x 32mm | 1 salida  |
| 563161 | 12V | IP66 | 250W | 273 x 73 x 44mm | 4 salidas |

FUENTE ALIMENTACIÓN 24V

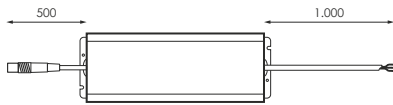

|  |  |  |          |  |  |
|--|--|--|----------|--|--|
|  |  |  | <b>W</b> |  |  |
|--|--|--|----------|--|--|

|        |          |     |      |                 |                 |           |
|--------|----------|-----|------|-----------------|-----------------|-----------|
| 488440 | 170-240V | 24V | 30W  | IP66/ IP44 Plug | 202 x 34 x 36mm | 1 salida  |
| 488457 | 170-240V | 24V | 60W  | IP66/ IP44 Plug | 197 x 45 x 32mm | 1 salida  |
| 488464 | 170-240V | 24V | 100W | IP66/ IP44 Plug | 248 x 45 x 32mm | 1 salida  |
| 481687 | 100-240V | 24V | 150W | IP66/ IP44 Plug | 230 x 63 x 39mm | 1 salida  |
| 571968 | 100-240V | 24V | 200W | IP66/ IP44 Plug | 260 x 73 x 45mm | 2 salidas |

EXTENSIÓN

STRING PIXELMAX

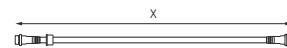

|  |  |  |  |
|--|--|--|--|
|  |  |  |  |
|--|--|--|--|

|        |       |  |      |
|--------|-------|--|------|
| 484312 | 0,25m |  | IP65 |
| 518154 | 0,50m |  | IP65 |
| 484329 | 1m    |  | IP65 |
| 484336 | 3m    |  | IP65 |
| 518161 | 5m    |  | IP65 |
| 518178 | 10m   |  | IP65 |

### CONECTOR-FUENTE ALIMENTACIÓN

STRING PIXELMAX

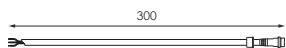

|        |  |     |      |
|--------|--|-----|------|
|        |  |     |      |
| 484305 |  | CII | IP66 |

### CONECTOR MACHO-HEMбра POWER STOPPER

STRING PIXELMAX

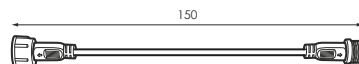

|                 |      |  |      |
|-----------------|------|--|------|
|                 |      |  |      |
| <b>N</b> 580335 | 15cm |  | IP65 |

### CONECTOR MACHO-MACHO

STRING PIXELMAX

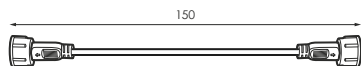

|                 |      |  |      |
|-----------------|------|--|------|
|                 |      |  |      |
| <b>N</b> 580342 | 15cm |  | IP65 |

### CONECTOR HEMBРА-HEMбра

STRING PIXELMAX

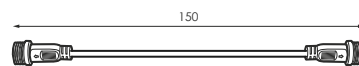

|                 |      |  |      |
|-----------------|------|--|------|
|                 |      |  |      |
| <b>N</b> 580359 | 15cm |  | IP65 |

### CONECTOR T ENTRADA

STRING PIXELMAX

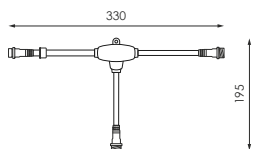

|        |  |      |
|--------|--|------|
|        |  |      |
| 484299 |  | IP65 |

### CONECTOR T

STRING PIXELMAX

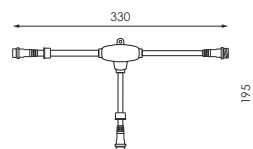

|        |  |      |
|--------|--|------|
|        |  |      |
| 484343 |  | IP65 |

### CONECTOR 3

STRING PIXELMAX

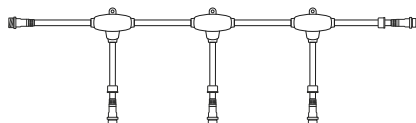

|        |  |      |
|--------|--|------|
|        |  |      |
| 484350 |  | IP65 |

### CONECTOR 5

STRING PIXELMAX

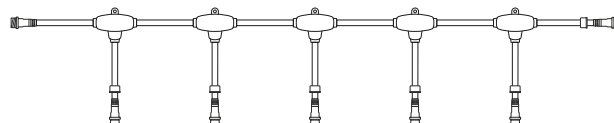

|        |  |      |
|--------|--|------|
|        |  |      |
| 484367 |  | IP65 |

### TAPA FINAL

STRING PIXELMAX



|        |  |
|--------|--|
|        |  |
| 594738 |  |

### CONECTOR-FUENTE ALIMENTACIÓN

DOT DMX PIXELMAX

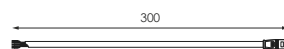

|        |  |     |      |
|--------|--|-----|------|
|        |  |     |      |
| 485197 |  | CII | IP66 |



### EXTENSIÓN

DOT DMX PIXELMAX

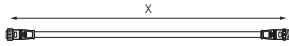

| Barcode | Length | Icon | IP Rating |
|---------|--------|------|-----------|
| 484923  | 0,25m  |      | IP65      |
| 484930  | 1m     |      | IP65      |
| 484947  | 3m     |      | IP65      |

### CONECTOR T ENTRADA

DOT DMX PIXELMAX

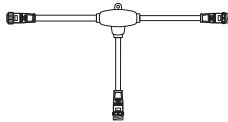

| Barcode | Icon | IP Rating |
|---------|------|-----------|
| 484916  |      | IP65      |

### CONECTOR 3

DOT DMX PIXELMAX/MESH PIXELMAX

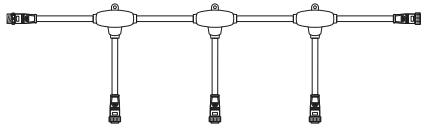

| Barcode | Icon | IP Rating |
|---------|------|-----------|
| 484961  |      | IP65      |

### TENSOR

MESH PIXELMAX

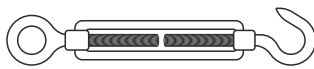

| Barcode | Icon | Material |
|---------|------|----------|
| 569989  |      | Acero    |

### EXTENSIÓN

MESH PIXELMAX

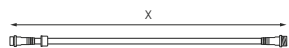

| Barcode | Length | Icon | IP Rating |
|---------|--------|------|-----------|
| 570350  | 1m     |      | IP65      |
| 570367  | 3m     |      | IP65      |
| 570374  | 5m     |      | IP65      |
| 570381  | 10m    |      | IP65      |

### CONECTOR 5

DOT DMX PIXELMAX

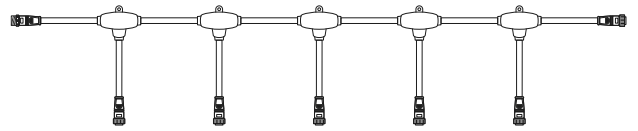

| Barcode | Icon | IP Rating |
|---------|------|-----------|
| 484978  |      | IP65      |

### CONECTOR T

DOT DMX PIXELMAX

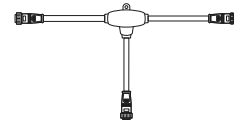

| Barcode | Icon | IP Rating |
|---------|------|-----------|
| 484954  |      | IP65      |

### CONECTOR T ENTRADA

MESH PIXELMAX

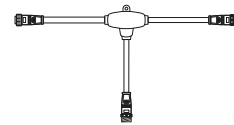

| Barcode | Icon | IP Rating |
|---------|------|-----------|
| 567992  |      | IP65      |

### CIERRE M4

MESH PIXELMAX

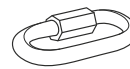

| Barcode | Icon | Material |
|---------|------|----------|
| 569996  |      | Acero    |

### ANILLO M3

MESH PIXELMAX



| Barcode | Icon | Material |
|---------|------|----------|
| 575560  |      | Acero    |

### CONECTOR A CONTROLADOR

MESH PIXELMAX

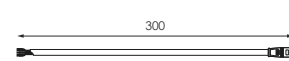

| Barcode | Icon |
|---------|------|
| 568982  |      |

CONTROLADOR SPI

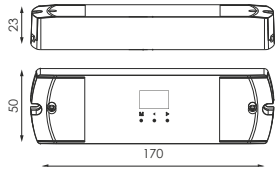

|        |          |      |                 |  |
|--------|----------|------|-----------------|--|
|        |          |      |                 |  |
| 472494 | 100-240V | IP20 | 170 x 50 x 23mm |  |

CONTROLADOR DMX-TRIAC

4 SALIDAS/32PROGRAMAS

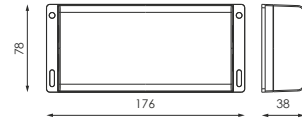

|          |           |             |      |      |  |
|----------|-----------|-------------|------|------|--|
|          |           |             |      |      |  |
| N 608633 | 12~36V dc | 4x(60-180)W | IP67 | 4x5A |  |

CONTROLADOR DMX-TRIAC

4 SALIDAS/32PROGRAMAS

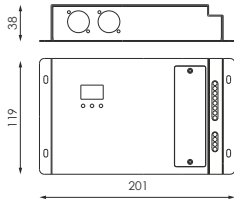

|          |             |              |      |      |  |
|----------|-------------|--------------|------|------|--|
|          |             |              |      |      |  |
| N 608640 | 110~240V dc | 4x(220-480)W | IP67 | 4x2A |  |

CONTROLADOR DMX

2 CANALES

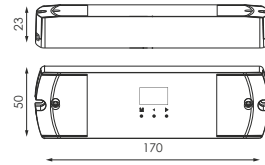

|        |          |          |     |      |      |
|--------|----------|----------|-----|------|------|
|        |          |          |     |      |      |
| 451154 | 100-240V | Max 220W | CII | IP20 | 2x1A |

FUNCIONES/FUNCTIONS/FONCTIONS/FUNÇÕES

Modo de regulación 2 canales automático.  
Modo dinámico automático.  
Modo decodificación DMX.

Automatic 2 channel regulation.  
Mode automatic dynamic.  
DMX decoding mode.

Mode de régulation automatique à 2 canaux.  
Mode dynamique automatique.  
Mode de décodage DMX.

Modo de regulação automática de 2 canais.  
Modo dinâmico automático.  
Modo de decodificação DMX.

CONTROLADOR/SLAVE SPI

8 SALIDAS/32 UNIVERSOS

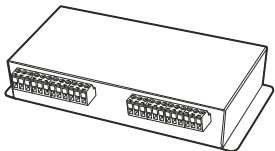

|        |          |      |                   |  |
|--------|----------|------|-------------------|--|
|        |          |      |                   |  |
| 568968 | 5~24V dc | IP20 | Max. 5.440 pixels |  |

CONTROLADOR SPI-DMX

16 SALIDAS/UNIVERSOS

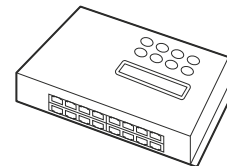

|        |        |      |   |  |
|--------|--------|------|---|--|
|        |        |      |   |  |
| 485159 | 12V dc | IP20 | SPI - Max. 21.760 pixels<br>DMX - Max. 2.048 pixels |  |

CONTROLADOR SPI

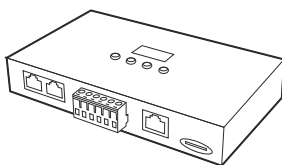

|        |          |      |                                   |  |
|--------|----------|------|-----------------------------------|--|
|        |          |      |                                   |  |
| 485173 | 5~24V dc | IP20 | 4 Salidas/<br>Max. 680 pixels     |  |
| 485180 | 5~24V dc | IP20 | 4x2 Salidas/<br>Max. 1.360 pixels |  |

CONTROLADOR DMX

8 UNIVERSOS

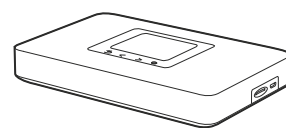

|        |       |      |                   |  |
|--------|-------|------|-------------------|--|
|        |       |      |                   |  |
| 485142 | 5V dc | IP20 | Max. 1.024 pixels |  |

CONTROLADOR DMX

2 UNIVERSOS

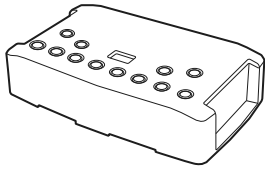

529037



9~36V dc



IP20



Max. 256 pixeles

CONTROLADOR DMX

1 UNIVERSO

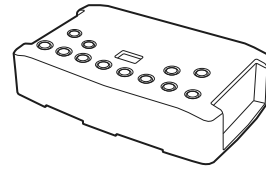

485135



9~36V dc



IP20



Max. 128 pixeles

AMPLIFICADOR DMX

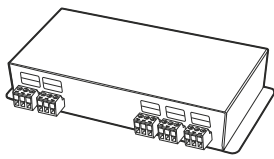

485166



12V dc



IP20

DIRECCIONADOR DMX

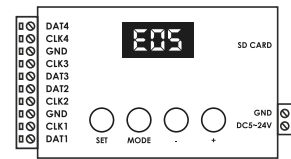

490245



IP20

CONTROLADOR SLAVE

SCREEN PIXELMAX

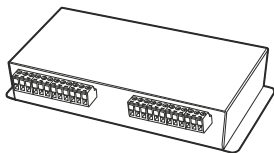

486460



66V



IP20



Max. 3200 pixeles

PF BOX

SCREEN PIXELMAX

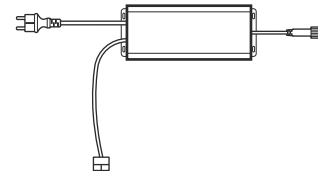

486477



66V



66W

CAJA ESTANCA

CON CONTROLADOR DMX1 UNIVERSO

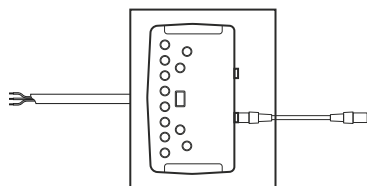

496902



IP65

BOX MASTER SPI

4 SALIDAS

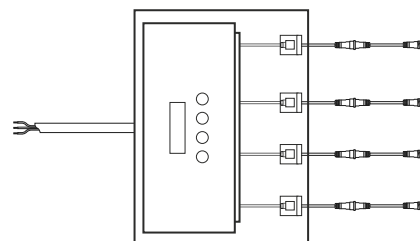

519236



IP65

BOX MASTER SPI

4x2 SALIDAS

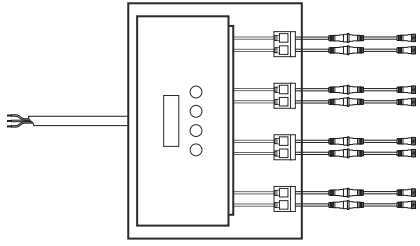

568562



IP65

BOX MASTER SPI

16 SALIDAS

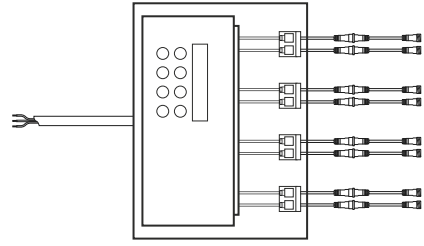

496445



IP65

BOX CONTROL DMX-TRIAC

4 SALIDAS/32 PROGRAMAS

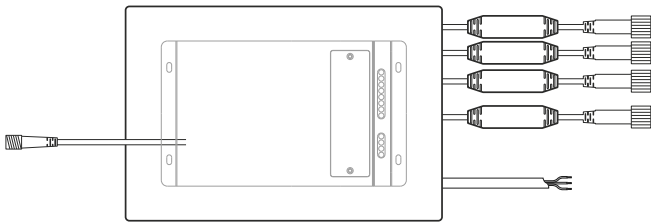

N 614900



IP66

BOX CONTROL PARA PRODUCTOS ESTÁTICOS

2 SALIDAS

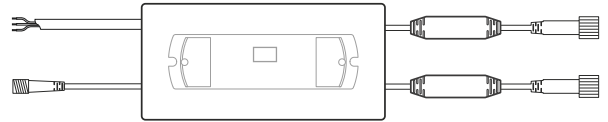

490641



IP65

BOX CONTROL PARA PRODUCTOS ESTÁTICOS

6 SALIDAS

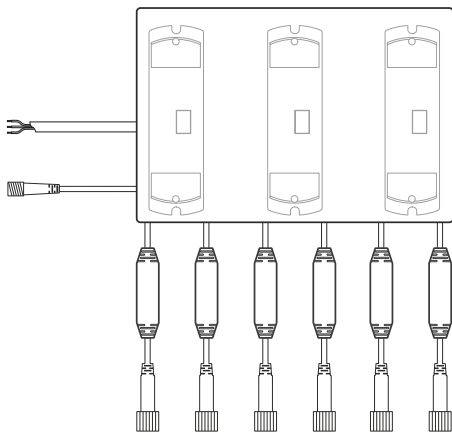

490658



IP65

BOX CONTROL PARA PRODUCTOS ESTÁTICOS

10 SALIDAS

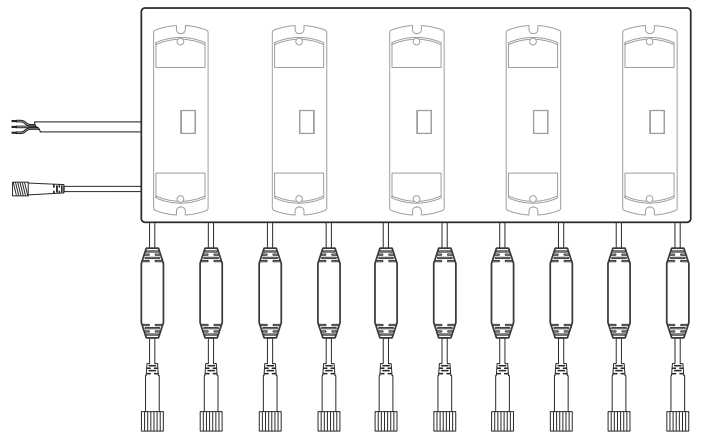

490665



IP65

[GRÁFICOS: Unidades en mm/ GRAPHICS: Units in mm/ GRAPHIQUES: Unités en mm/ GRÁFICOS: Unidades em mm]



MANGUERA DMX

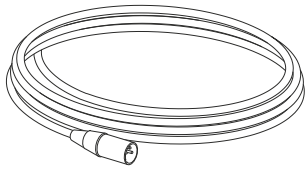

551779



rollo 100m

CABLE ETHERNET CON ADAPTADOR RJ4

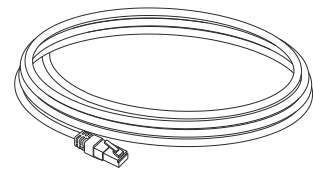

496735



25cm

CABLE ETHERNET

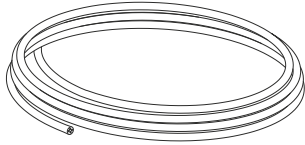

490740



1m

CABLE ALIMENTACIÓN

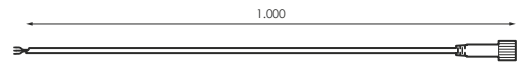

490191



1m



EXTENSIÓN DMX

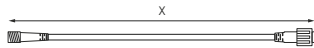

490207



1m



IP44

490214

3m



IP44

490221

5m



IP44

ADAPTADOR SMART LINK

SMART-FLEXILIGHT

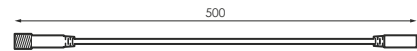

192477



IP65

192453



IP65

Termoretractil y conector macho **NO INCLUIDOS**  
 Heat-shrinkable and male connector **NOT INCLUDED**  
 Thermorétractable et connecteur mâle **NON INCLUS**  
 Tubo de contração térmica e conector macho **NÃO INCLUÍDO**



Mercat de Sants  
Barcelona





Flexilight

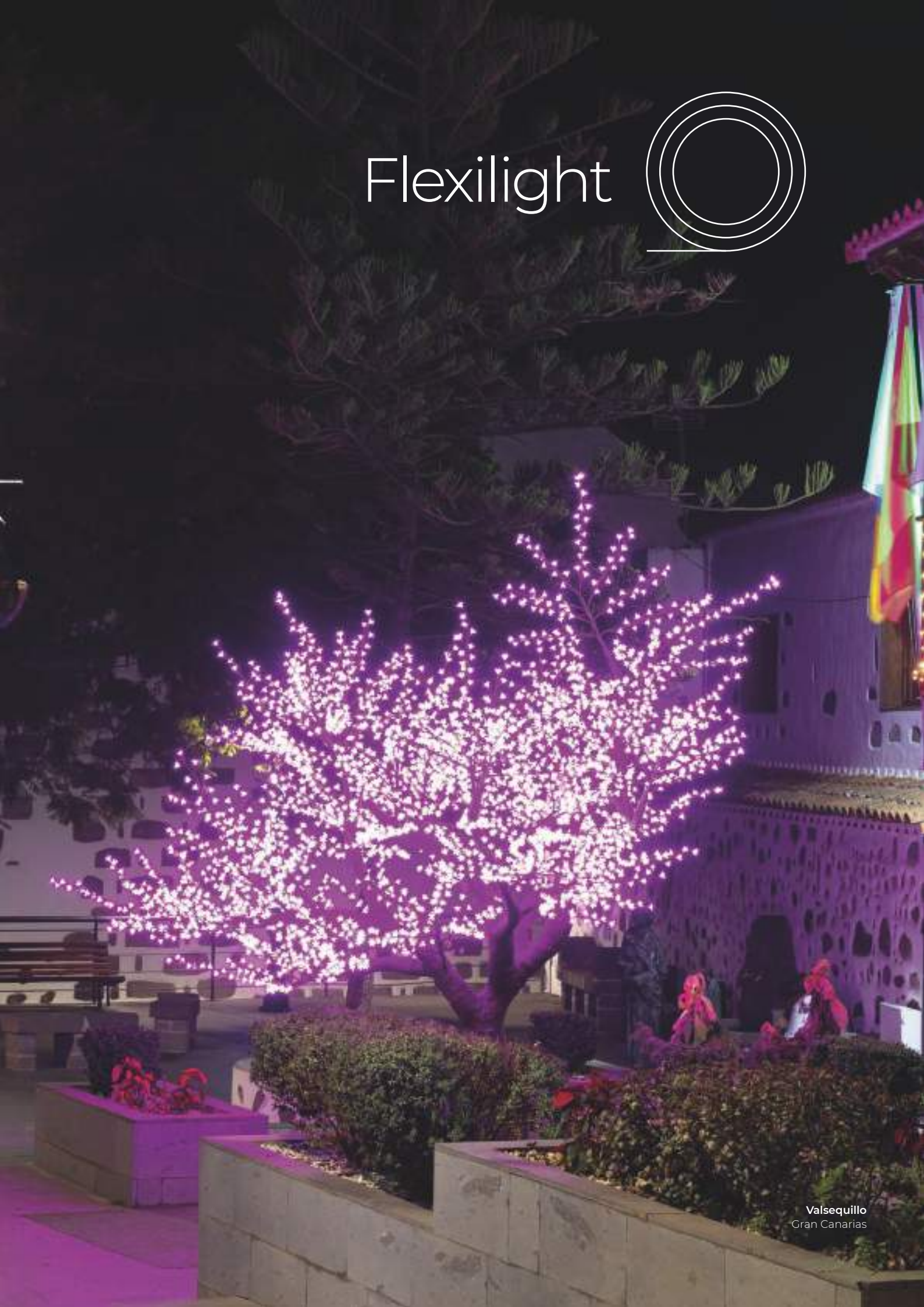



# flexiLIGHT Led

24V



Rota  
Cádiz

⚡ 24V dc

Hz 50-60Hz

⏏ CIII

⦿ IP44 PLUG

IP54

△ 360°

🌡 -20°C~+60 °C

📊 5,5kg (N.W.)

⊗ PS NO INC.

⊗ A NO INC.

🌀 Rollo 30m

Ñ/ Exterior/Textura Lisa/Tapa final **INCLUIDA**  
E/ Outside/Smooth Texture/End cap **INCLUDED**  
F/ A L'exterieur/Texture Lisse/Couvercle **INCLUS**  
P/ Exterior/Textura Lisa/Tampa final **INCLUIDA**

|        |     |     |
|--------|-----|-----|
|        | 💡   | ⦿   |
| 149167 | LED | PVC |
| 146432 | LED | PVC |
| 191876 | LED | PVC |
| 191883 | LED | PVC |
| 191906 | LED | PVC |
| 191913 | LED | PVC |

|    |           |
|----|-----------|
| ✂  | 16,6cm    |
| ∅  | 13mm      |
| 💡  | 36        |
| W% | 0,25W     |
| W  | 45W       |
| 🔗  | Max. 30m  |
| 🌀  | Rollo 30m |

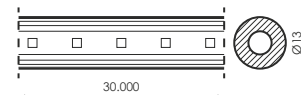

ESQUEMA INSTALACIÓN/  
INSTALLATION SCHEME/  
SCHEMA D'INSTALLATION/  
ESQUEMA DE  
INSTALACÃO



Producto/Product  
Produit/Produto

## Aviso/Warning/Avertissement/Aviso

Ñ/ Uso **OBLIGATORIO** de fuente de alimentació y adaptador.

E/ You **MUST USE** the power supply and adapter.

F/ L'utilisation **OBLIGATOIRE** du alimentation et adaptateur.

P/ Uso **OBRIGATÓRIO** de fonte de alimentação e adaptador.

## Accesorios (NO Incluidos) / Accessoires (NOT Included) / Accessories (NON Inclus)/ Acessórios (NÃO Incluso)

+ INFO PAG. 328

Ñ/ Fuente de alimentación y adaptador **NO INCLUIDA**

E/ Power supply and adapter **NOT INCLUDED**

F/ Alimentation et adaptateur **NON INCLUSE**

P/ Fonte de alimentação e adaptador **NÃO INCLUIDO**

488440

Fuente alimentación 30W 24V

488464

Fuente alimentación 100W 24V

571968

Fuente alimentación 200W 24V

488457

Fuente alimentación 60W 24V

481687

Fuente alimentación 150W 24V

194556

Adaptador

# flexiLIGHT Led

## 24V Flashing

|           |              |
|-----------|--------------|
|           | 24V dc       |
| <b>Hz</b> | 50-60Hz      |
|           | CIII         |
|           | IP44 PLUG    |
|           | IP54         |
|           | 360°         |
|           | -20°C~+60 °C |
|           | 5,5kg (N.W.) |
|           | NO INC.      |
|           | NO INC.      |
|           | Rollo 30m    |



Cuidad de Braga 2020  
by AM Illumination  
Producto Prilux



Ñ/ Exterior/Textura Lisa/Tapa final **INCLUIDA**  
E/ Outside/Smooth Texture/End cap **INCLUDED**  
F/ À L'exterieur/Texture Lisse/Couvercle **INCLUS**  
P/ Exterior/Textura Lisa/Tampa final **INCLUÍDA**

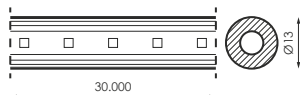

ESQUEMA INSTALACIÓN/  
INSTALLATION SCHEME/  
SCHEMA D'INSTALLATION/  
ESQUEMA DE  
INSTALAÇÃO



|          |                  |
|----------|------------------|
|          | 16,6cm           |
|          | 13mm             |
|          | 30+6<br>flashing |
|          | 0,25W            |
| <b>W</b> | 45W              |
|          | Max. 30m         |
|          | Rollo 30m        |

|        |  |  |
|--------|--|--|
|        |  |  |
| 545761 |  |  |
| 545778 |  |  |

### Aviso/Warning/Avertissement/Aviso

Ñ/ Uso **OBLIGATORIO** de fuente de alimentació y adaptador.

E/ You **MUST USE** the power supply and adapter.

F/ L'utilisation **OBLIGATOIRE** du alimentation et adaptateur.

P/ Uso **OBRIGATÓRIO** de fonte de alimentação e adaptador.

### Accesorios (NO Incluidos) / Accessoires (NOT Included) / Accessories (NON Inclus)/ Acessórios (NÃO Incluso)

+ INFO PAG. 328

Ñ/ Fuente de alimentación y adaptador **NO INCLUIDA**

E/ Power supply and adapter **NOT INCLUDED**

F/ Alimentation et adaptateur **NON INCLUSE**

P/ Fonte de alimentação e adaptador **NÃO INCLUÍDO**

|        |                              |
|--------|------------------------------|
| 488440 | Fuente alimentación 30W 24V  |
| 488464 | Fuente alimentación 100W 24V |
| 571968 | Fuente alimentación 200W 24V |

|        |                              |
|--------|------------------------------|
| 488457 | Fuente alimentación 60W 24V  |
| 481687 | Fuente alimentación 150W 24V |
| 194556 | Adaptador                    |

# flexiLIGHT Led

## Bombilla Horizontal



Casa Seat  
Barcelona

⚡ 230V ac

Hz 50-60Hz

□ CII

☺ 1 Canal/ 2 Vías

⊙ IP44 PLUG

⊙ IP65

△ 360°

🌡 -20°C~+60 °C

📊 7,8kg (N.W.)

🔌 INC.

🌀 Rollo 45m

Ñ/ Exterior/Textura Lisa/Tapa final **INCLUIDA**  
E/ Outside/Smooth Texture/End cap **INCLUDED**  
F/ A L'exterior/Texture Lisse/Couvercle **INCLUS**  
P/ Exterior/Textura Lisa/Tampa final **INCLUIDA**

|        |     |     |
|--------|-----|-----|
|        | 💡   | ⊙   |
| 952750 | LED | PVC |
| 995078 | 💎   | PVC |
| 995085 | LED | PVC |
| 952767 | LED | PVC |
| 952781 | LED | PVC |
| 952774 | LED | PVC |
| 952798 | LED | PVC |
| 191814 | LED | PVC |
| 191807 | LED | PVC |
| 952811 | LED | PVC |
| 961158 | LED | PVC |
| 150316 | LED | PVC |

|     |           |
|-----|-----------|
| ✂   | 1m        |
| ∅   | 13mm      |
| 💡   | 36        |
| W/⊕ | 3W        |
| W   | 135W      |
| +   | Max. 90m  |
| 🌀   | Rollo 45m |

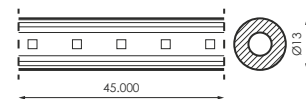

Accesorios (NO Incluidos) / Accessoires (NOT Included) / Accessories (NON Inclus) / Acessórios (NÃO Incluso)

+ INFO PAG. 328

952828

Cable alimentación Negro

150330

Cable alimentación Blanco



# flexiLIGHT Led

## Flashing

|           |                 |
|-----------|-----------------|
|           | 230V ac         |
| <b>Hz</b> | 50-60Hz         |
|           | CII             |
|           | 1 Canal/ 2 Vías |
|           | IP44 PLUG       |
|           | IP65            |
|           | 360°            |
|           | -20°C~+60 °C    |
|           | 7,9kg (N.W.)    |
|           | INC.            |
|           | Rollo 45m       |



Hotel Claris Grand Luxe  
Barcelona

Ñ/ Exterior/Textura Lisa/Tapa final **INCLUIDA**  
 E/ Outside/Smooth Texture/End cap **INCLUDED**  
 F/ À L'exterieur/Texture Lisse/Couvercle **INCLUS**  
 P/ Exterior/Textura Lisa/Tampa final **INCLUÍDA**

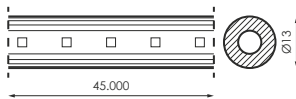

|          |               |         |  |  |
|----------|---------------|---------|--|--|
|          | 1,5m          |         |  |  |
|          | 13mm          | 484190  |  |  |
|          | 30+6 flashing | 970853  |  |  |
|          | 3,5W *4,2W    | 953368  |  |  |
| <b>W</b> | 105W *125W    | 386944  |  |  |
|          | Max. 90m      | 386951  |  |  |
|          | Rollo 45m     | 386968* |  |  |
|          |               | 386975* |  |  |
|          |               | 386982  |  |  |
|          |               | 386999  |  |  |

Accesorios (NO Incluidos) / Accessoires (NOT Included) / Accessories (NON Inclus) / Acessórios (NÃO Incluso)  
 + INFO PAG. 328

952828

Cable alimentación Negro

150330

Cable alimentación Blanco



# flexiLIGHT Led

## Bombilla Vertical



Arucas  
Gran Canarias

⚡ 230V ac

Hz 50-60Hz

□ CII

☺ 1 Canal/ 2 Vías

⊙ IP44 PLUG

IP65

∠ 120°

🌡 -20°C~+60 °C

📊 8kg (N.W.)

🍷 INC.

📦 Rollo 45m

Ñ/ Exterior/Textura Lisa/Tapa final **INCLUIDA**  
 E/ Outside/Smooth Texture/End cap **INCLUDED**  
 F/ A L'extérieur/Texture Lisse/Couvercle **INCLUS**  
 P/ Exterior/Textura Lisa/Tampa final **INCLUIDA**



|        |     |     |
|--------|-----|-----|
|        | 💡   | ⊙   |
| 163347 | LED | BYC |
| 163392 | LED | BYC |
| 163354 | LED | BYC |
| 163378 | LED | BYC |
| 163385 | LED | BYC |
| 163361 | LED | BYC |

|     |           |
|-----|-----------|
| ✂   | 1,5m      |
| ∅   | 13mm      |
| 💡   | 36        |
| W/⊕ | 3,5W      |
| W   | 105W      |
| 🔌   | Max. 90m  |
| 🌀   | Rollo 45m |

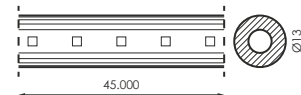

Accesorios (NO Incluidos) / Accessoires (NOT Included) / Accessories (NON Inclus) / Acessórios (NÃO Incluso)

+ INFO PAG. 328

952828

Cable alimentación Negro

150330

Cable alimentación Blanco

# flexiLIGHT Led

## Dual

|  |              |
|--|--------------|
|  | 230V ac      |
|  | 50-60Hz      |
|  | CII          |
|  | IP44 PLUG    |
|  | IP54         |
|  | 360°         |
|  | -20°C~+60 °C |
|  | 8kg (N.W.)   |
|  | INC.         |
|  | Rollo 45m    |



El Pozo  
Alama de Murcia

[GRÁFICOS: Unidades en mm/ GRÁFICOS: Units in mm/ GRAPHICS: Units in mm/ GRÁFICOS: Unidades em mm]

Ñ/ Exterior/Textura Lisa/Tapa final **INCLUIDA**  
 E/ Outside/Smooth Texture/End cap **INCLUDED**  
 F/ À L'exterieur/Texture Lisse/ Couvercle **INCLUS**  
 P/ Exterior/Textura Lisa/Tampa final **INCLUIDA**

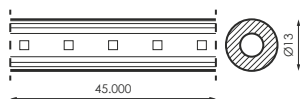

|          |            |        |  |  |
|----------|------------|--------|--|--|
|          | 1m         |        |  |  |
|          | 13mm       | 191821 |  |  |
|          | 36         |        |  |  |
|          | 3W         |        |  |  |
| <b>W</b> | 135W       |        |  |  |
|          | Ver acces. |        |  |  |
|          | Rollo 45m  |        |  |  |

### Aviso/Warning/Avertissement/Aviso

Ñ/Los efectos de cambio de color solo funcionan con el controlador que es de **USO OBLIGATORIO**.

E/ The color change effects only work with the controller that is **OBLIGATORY**.

F/ Les effets de changement de couleur fonctionnent uniquement avec le contrôleur qui est **OBLIGATOIRE**.

P/ Os efeitos de mudança de cor funcionam apenas com o controlador que é **USO OBRIGATÓRIO**.

### Accesorios (NO Incluidos) / Accessoires (NOT Included) / Accessories (NON Inclus) / Acessórios (NÃO Incluso)

+ INFO PAG. 328

Ñ/La máxima longitud por alimentación, dependerá del controlador a utilizar.

E/ Maximum length for power, will depend on the driver to use.

F/ Longueur maximale pour le pouvoir, dépendra le pilote à utiliser.

P/ Comprimento máximo para o poder, vai depender do driver para uso.

391559

Controlador dual 8 Funciones (Necesita adaptador)

194556

Adaptador 24V a Flexilight

971072

Controlador dual 4 Funciones (Necesita adaptador)

# flexiLIGHT Led Avant

IP67



⚡ 230V ac

Hz 50-60Hz

□ CII

⊙ 1 Canal/ 2 Vías

⊙ IP44 PLUG

⊙ IP67

∠ 360°

🌡️ -20°C~+60 °C

📊 8,3kg (N.W.)

🍷 INC.

📦 Rollo 45m

Ñ/ Exterior/Textura Lisa/Tapa final **INCLUIDA**  
 E/ Outside/Smooth Texture/End cap **INCLUDED**  
 F/ A L'extérieur/Texture Lisse/ **Couvercle INCLUS**  
 P/ Exterior/Textura Lisa/Tampa final **INCLUIDA**



Plaza Lagos  
Ecuador

|        |     |     |
|--------|-----|-----|
|        | 💡   | ⊙   |
| 488655 | LED | PVC |
| 488662 | LED | PVC |
| 488679 | LED | PVC |
| 488686 | LED | PVC |
| 488693 | LED | PVC |

|    |           |
|----|-----------|
| ✂️ | 1m        |
| ∅  | 13mm      |
| ☀️ | 36        |
| W% | 3W        |
| W  | 135W      |
| 🔗  | Max. 90m  |
| ⊙  | Rollo 45m |

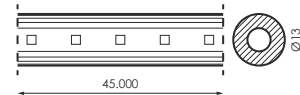

## Aviso/Warning/Avertissement/Aviso

Ñ/ Para que la conexión a la línea eléctrica sea IP67, la alimentación deberá ir en caja estanca. Perdida de IP al cortar el producto.

E/ In order for the connection to the powerline to be IP67, the power supply must be in a sealed box. Loss of IP when cutting the product.

F/ Pour que la connexion à la ligne électrique soit IP67, l'alimentation doit être dans un boîtier scellé. Perte de propriété intellectuelle lors de la découpe du produit.

P/ Para que a conexão à linha de energia seja IP67, a fonte de alimentação deve estar em uma caixa selada. Perda de IP ao cortar o produto.

Accesorios (NO Incluidos) / Accessoires (NOT Included) / Accessories (NON Inclus) / Acessórios (NÃO Incluso)

+ INFO PAG. 328

487184  
Cable alimentación Negro

487191  
Cable alimentación Blanco





Zaragoza



# flexiLIGHT Led Chasing

24V

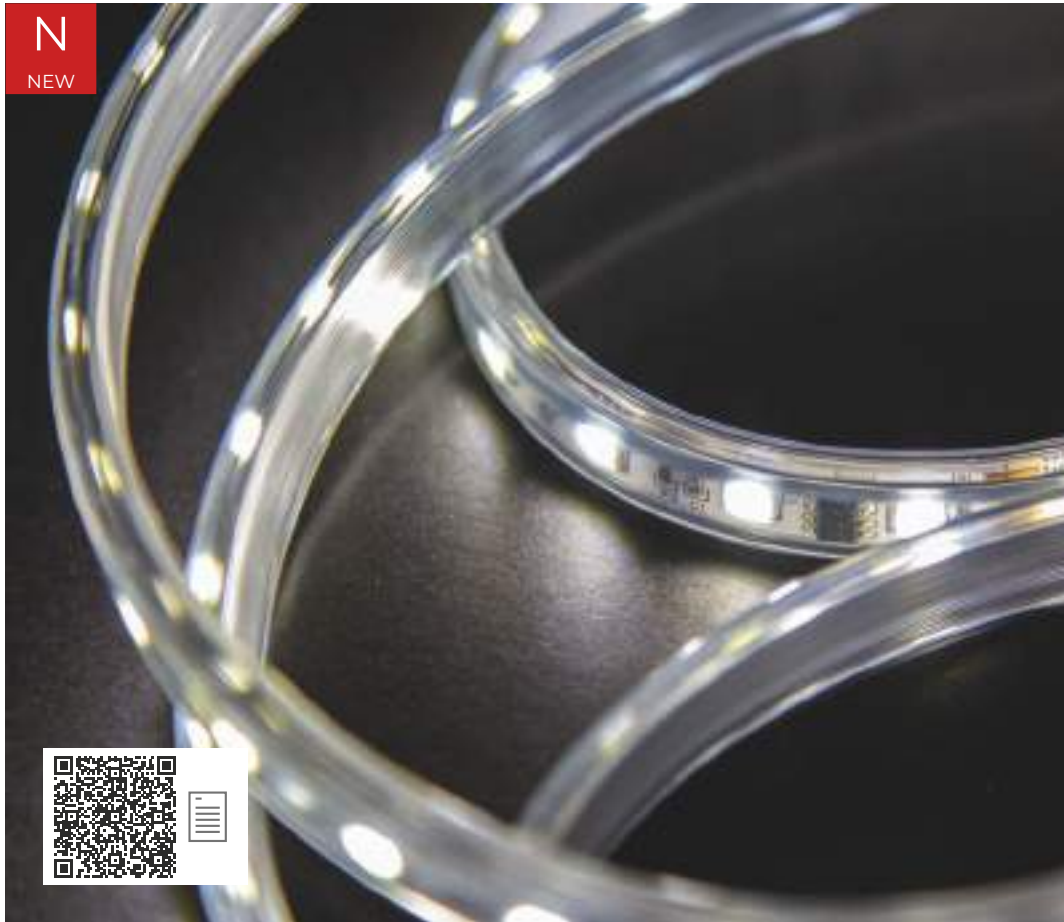

⚡ 24V

Hz 50-60Hz

◇ CIII

IP44 PLUG

IP65

△ 120°

Ⓚ/kg 4kg (N.W.)

ⓧ<sub>PS</sub> NO INC.

ⓧ<sub>C</sub> NO INC.

Ⓜ Rollo 15m

**N/ Exterior/Tapa final INCLUIDA**  
**E/ Outside/End cap INCLUDED**  
**F/ À L'extérieur/Couvercle INCLUS**  
**P/ Exterior/Tampa final INCLUIDA**

|        |  |  |
|--------|--|--|
|        |  |  |
| 633598 |  |  |
| 633604 |  |  |

|     |  |
|-----|--|
|     | 10cm   |
| ∅   | 5,5x13,6mm                                   |
|     | 60   |
| W/m | 7W   |
| W   | 105W   |
|     | Max. 15m en línea<br>Max. 30m po controlador |
|     | Rollo 15m                                    |

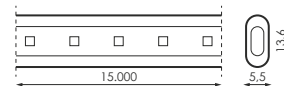

ESQUEMA INSTALACIÓN/  
 INSTALLATION SCHEME/  
 SCHEMA D'INSTALLATION/  
 ESQUEMA DE INSTALAÇÃO

ⓧ<sub>PS</sub> + ⓧ<sub>C</sub>

Producto/Product  
 Produit/Produto

## Accesorios (NO Incluidos) / Accessoires (NOT Included) / Accessories (NON Inclus)/ Acessórios (NÃO Incluso)

+ INFO PAG. 328

|        |                                    |
|--------|------------------------------------|
| 633611 | Controlador con mando              |
| 633666 | Adaptador 24V a Flexilight Chasing |
| 481687 | Fuente alimentación 150W 24V       |

|        |                              |
|--------|------------------------------|
| 633628 | Conector T                   |
| 488440 | Fuente alimentación 30W 24V  |
| 571968 | Fuente alimentación 200W 24V |

|        |                             |
|--------|-----------------------------|
| 633635 | Conector 5                  |
| 488457 | Fuente alimentación 60W 24V |

|        |                              |
|--------|------------------------------|
| 633642 | Tapa final                   |
| 488464 | Fuente alimentación 100W 24V |



# flexiLIGHT Led

## Neon



Hasta 5 años de garantía.  
Ver condiciones de uso  
**Up to 5 years of warranty**  
See terms of use  
**Jusqu'à 5 ans de garantie**  
Voir condition d'utilisation  
**Até 5 anos de garantia**  
Ver condições de uso



⚡ 230V ac

Hz 50-60Hz

□ CII

☉ 1 Canal/ 2 Vías

⊙ IP44 PLUG

⊙ IP66

∠ 120°

🌡️ -25°C~+60 °C

📊 10,2kg (N.W.)

🔌 INC. (x2)

🌀 Rollo 50m

**N/** ideal para instalaciones fijas de exterior  
**E/** ideal for outside installations  
**F/** ideal pour services a l'exterieur fixes  
**P/** deal para instalações exteriores fixa

|        |  |  |
|--------|--|--|
|        |  |  |
| 445603 |  |  |
| 445610 |  |  |

|    |           |
|----|-----------|
|    | 50cm      |
| ∅  | 13,5x25mm |
|    | 120       |
| W% | 5W        |
| W  | 500W      |
|    | Max. 50m  |
| 🌀  | Rollo 50m |

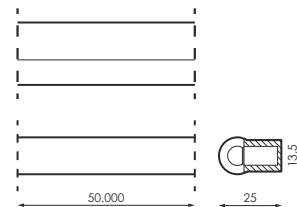

### Aviso/Warning/Avertissement/Aviso

**N/** Cada rollo se sirve con dos cables de alimentación y tapa final.  
Regulable con TRIAC que realice el corte a principio y fin de fase indistintamente.

**E/** Each roll is served with two power cords and End cap.  
Adjustable with TRIAC that performs the cut at the beginning and end of the phase interchangeably.

**F/** Chaque rouleau est servi avec deux cordons d'alimentation et couvercle.  
Réglable avec TRIAC qui effectue la coupe au début et à la fin de la phase de manière interchangeable.

**P/** Cada rolo é servido com dois cabos de alimentação e tampa final.  
Ajustável com TRIAC que executa o corte no início e no final da fase de maneira intercambiável.

### Accesorios (NO Incluidos) / Accessoires (NOT Included) / Accessories (NON Inclus) / Acessórios (NÃO Incluso)

+ INFO PAG. 328

|                           |
|---------------------------|
| 445627                    |
| Cable alimentación Blanco |
| 445641                    |
| Empalme L                 |









|                |
|----------------|
| 445634         |
| Empalme simple |
| 445665         |
| Canaleta 1m    |

|            |
|------------|
| 445658     |
| Tapa final |
| 445689     |
| Pegamento  |

|                |
|----------------|
| 445672         |
| Clip sujección |

# flexiLIGHT Led









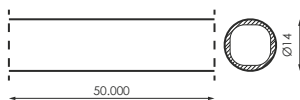



Neon 360°

|   |                 |
|---|-----------------|
|  | 230V ac         |
| <b>Hz</b>   | 50-60Hz         |
|  | CII             |
|  | 1 Canal/ 2 Vías |
|  | IP44 PLUG       |
|   | IP65            |
|  | 360°            |
|  | -20°C~+60 °C    |
|  | 10kg (N.W.)     |
|  | INC.            |
|  | Rollo 50m       |



**Ñ/ Exterior/Textura Lisa/Tapa final INCLUIDA**  
**E/ Outside/Smooth Texture/End cap INCLUDED**  
**F/ À L'exterieur/Texture Lisse/Couvercle INCLUS**  
**P/ Exterior/Textura Lisa/Tampa final INCLUÍDA**



|   |           |   |   |   |
|---|-----------|---|---|---|
|  | 1m        |  |  |  |
|  | 14mm      | 546317  |  |  |
|  | 240       | 546324  |  |  |
|  | 9,5W      |   |   |   |
| <b>W</b>  | 475W      |   |   |   |
|  | Max. 50m  |   |   |   |
|  | Rollo 50m |   |   |   |

Accesorios (NO Incluidos) / Accessoires (NOT Included) / Accessories (NON Inclus)/ Acessórios (NÃO Incluso)

+ INFO PAG. 328

546393  
Cable alimentación Blanco

546409  
Empalme simple

546416  
Tapa final

546423  
Clip sujección



# flexiLIGHT Led

## Mini Neon Slim



⚡ 230V ac

Hz 50-60Hz

□ CII

⊙ 1 Canal/ 2 Vías

⊙ IP44 PLUG

⊙ IP65

∠ 360°

🌡 -20°C~+60 °C

📊 10,2kg (N.W.)

🔌 INC.

📦 Rollo 50m

Ñ/ Exterior/Textura Lisa/Tapa final **INCLUIDA**  
 E/ Outside/Smooth Texture/End cap **INCLUDED**  
 F/ A L'exterieur/Texture Lisse/Couvercle **INCLUS**  
 P/ Exterior/Textura Lisa/Tampa final **INCLUIDA**



|        |  |  |
|--------|--|--|
|        |  |  |
| 546355 |  |  |
| 546362 |  |  |

|     |           |
|-----|-----------|
|     | 1m        |
| ∅   | 15x14mm   |
|     | 120       |
| W/⊕ | 9W        |
| W   | 450W      |
|     | Max. 50m  |
| ⊙   | Rollo 50m |

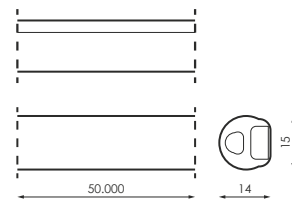

ESQUEMA DE DOBLADO

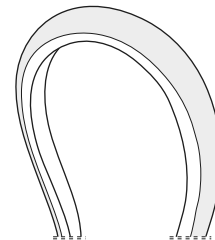

Accesorios (NO Incluidos) / Accessoires (NOT Included) / Accessories (NON Inclus)/ Acessórios (NÃO Incluso)

+ INFO PAG. 328

546478  
Cable alimentación Blanco

546485  
Empalme simple

546492  
Tapa final

546508  
Clip sujección

# flexiLIGHT Led

## Mini Neon

|           |                 |
|-----------|-----------------|
|           | 230V ac         |
| <b>Hz</b> | 50-60Hz         |
|           | CII             |
|           | 1 Canal/ 2 Vías |
|           | IP44 PLUG       |
|           | IP65            |
|           | 360°            |
|           | -20°C~+60 °C    |
|           | 9,4kg (N.W.)    |
|           | INC.            |
|           | Rollo 50m       |

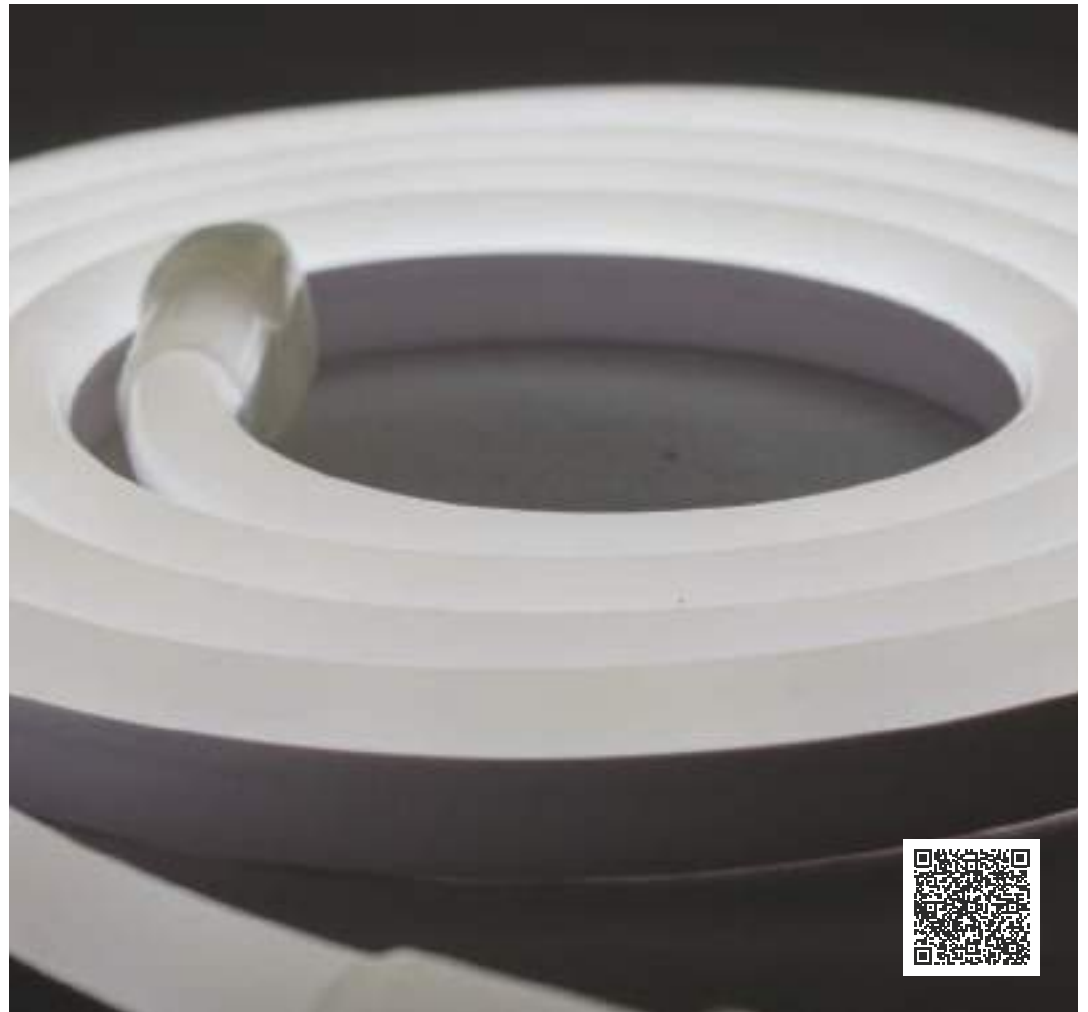

**N**/ Exterior/Textura Lisa/**Tapa final INCLUIDA**  
**E**/ Outside/Smooth Texture/**End cap INCLUDED**  
**F**/ À L'exterieur/Texture Lisse/**Couvercle INCLUS**  
**P**/ Exterior/Textura Lisa/**Tampa final INCLUÍDA**

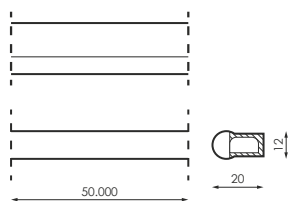

ESQUEMA DE DOBLADO



|          |           |        |  |  |
|----------|-----------|--------|--|--|
|          | 1m        |        |  |  |
|          | 12x20mm   | 546331 |  |  |
|          | 120       | 546348 |  |  |
|          | 9W        |        |  |  |
| <b>W</b> | 450W      |        |  |  |
|          | Max. 50m  |        |  |  |
|          | Rollo 50m |        |  |  |

Accesorios (NO Incluidos) / Accessoires (NOT Included) / Accessories (NON Inclus)/ Acessórios (NÃO Incluso)  
 + INFO PAG. 328

|        |                           |
|--------|---------------------------|
| 546430 | Cable alimentación Blanco |
|--------|---------------------------|

|        |                |
|--------|----------------|
| 546447 | Empalme simple |
|--------|----------------|

|        |            |
|--------|------------|
| 546454 | Tapa final |
|--------|------------|

|        |               |
|--------|---------------|
| 546461 | Clip sujeción |
|--------|---------------|

# flexiLIGHT Led

## Double Neon



⚡ 230V ac

Hz 50-60Hz

□ CII

⊙ 1 Canal/ 2 Vías

⊙ IP44 PLUG

⊙ IP65

△ 360°

🌡️ -20°C~+60 °C

📊 8kg (N.W.)

🔌 INC.

🌀 Rollo 50m

Ñ/ Exterior/Textura Lisa/Tapa final **INCLUIDA**  
 E/ Outside/Smooth Texture/End cap **INCLUDED**  
 F/ A L'exterieur/Texture Lisse/Couvercle **INCLUS**  
 P/ Exterior/Textura Lisa/Tampa final **INCLUIDA**



|        |  |  |
|--------|--|--|
|        |  |  |
| 546379 |  |  |
| 546386 |  |  |
| 481588 |  |  |
| 481571 |  |  |
| 481564 |  |  |
| 481595 |  |  |

|  |           |
|--|-----------|
|  | 1m        |
|  | 9x16mm    |
|  | 120       |
|  | 9W        |
|  | 450W      |
|  | Max. 50m  |
|  | Rollo 50m |

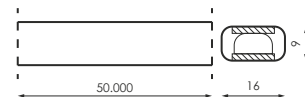

ESQUEMA DE DOBLADO

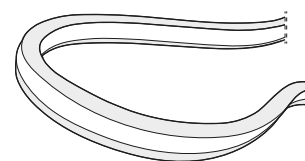

### Accesorios (NO Incluidos) / Accessoires (NOT Included) / Accessories (NON Inclus)/ Acessórios (NÃO Incluso)

+ INFO PAG. 328

|        |   |
|--------|---|
| 546515 | Cable alimentación Blanco                     |
| 518635 | Adaptador Smart Link a Flexilight Double Neon |
| 523622 | Extensión 50cm blanco                         |











|        |   |
|--------|---|
| 546522 | Empalme simple                                |
| 523615 | Adaptador Flexilight Double Neon a Smart Link |
| 566377 | Extensión 1m Blanco                           |

|        |                |
|--------|----------------|
| 546539 | Tapa final     |
| 518611 | Conector macho |

|        |                  |
|--------|------------------|
| 546546 | Clip sujección   |
| 523639 | Empalme sencillo |

# flexiLIGHT Led

## Double Neon 24V

|   |                 |
|---|-----------------|
|  | 24V             |
| <b>Hz</b>   | 50-60Hz         |
|   | CIII            |
|   | 1 Canal/ 2 Vías |
|   | IP65            |
|   | 360°            |
|   | -20°C~+60 °C    |
|   | 5,5kg (N.W.)    |
|   | NO INC.         |
|   | NO INC.         |
|   | Rollo 20m       |



Ñ/ Exterior/Textura Lisa/Tapa final **INCLUIDA**  
 E/ Outside/Smooth Texture/End cap **INCLUDED**  
 F/ À L'extérieur/Texture Lisse/Couvercle **INCLUS**  
 P/ Exterior/Textura Lisa/Tampa final **INCLUÍDA**

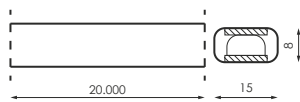







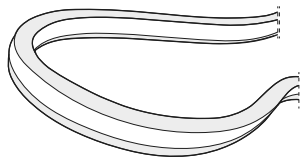





ESQUEMA INSTALACIÓN/  
 INSTALLATION SCHEME/  
 SCHEMA D'INSTALLATION/  
 ESQUEMA DE INSTALAÇÃO



ESQUEMA DE DOBLADO



|   |           |   |   |   |
|---|-----------|---|---|---|
|  | 50cm      |  |  |  |
|  | 8x15mm    | 599856  |  |  |
|  | 120       | 599863  |  |  |
|  | 2,5W      |   |   |   |
| <b>W</b>  | 82W       |   |   |   |
|  | Max. 20m  |   |   |   |
|  | Rollo 20m |   |   |   |

Accesorios (NO Incluidos) / Accessoires (NOT Included) / Accessories (NON Inclus)/ Acessórios (NÃO Incluso)  
 + INFO PAG. 328

|                             |                              |   |  |
|-----------------------------|------------------------------|---|--|
| 488457                      | 488464                       | 481687  | 571968                                 |
| Fuente alimentación 60W 24V | Fuente alimentación 100W 24V | Fuente alimentación 150W 24V                  | Fuente alimentación 200W 24V           |
| 600934                      | 600927                       | 599870  | 600910                                 |
| Empalme                     | Tapa final                   | Adaptador Flexilight Double Neon a fuente 24V | Adaptador Flexilight Double Neon a 24V |
| 601511                      |                              |   |  |
| Conector macho              |                              |   |  |



# flexiLIGHT Led

## Maxibrillo



⚡ 230V ac

Hz 50-60Hz

□ CII

☉ 1 Canal/ 2 Vías

⊙ IP44 PLUG

⊙ IP65

∠ 120°

🌡️ -20°C~+60 °C

📊 8,2kg (N.W.)

🔌 INC.

📦 Rollo 50m

Ñ/ Exterior/Textura Lisa/Tapa final **INCLUIDA**  
 E/ Outside/Smooth Texture/End cap **INCLUDED**  
 F/ A L'extérieur/Texture Lisse/Couvercle **INCLUS**  
 P/ Exterior/Textura Lisa/Tampa final **INCLUIDA**



|         |     |   |
|---------|-----|---|
|         | 💡   | ⊙ |
| 588171* | LED | 🔌 |
| 576031* | LED | 🔌 |
| 588959  | LED | 🔌 |
| 576048  | LED | 🔌 |
| 576055  | LED | 🔌 |
| 576062  | LED | 🔌 |

|     |               |
|-----|---------------|
| ✂️  | 1m            |
| ∅   | 12x6mm        |
| ☀️  | 60            |
| W/⊕ | *9,5W<br>5W   |
| W   | *475W<br>250W |
| 🔌   | Max. 50m      |
| ☉   | Rollo 50m     |

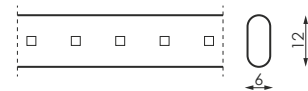

### Accesorios (NO Incluidos) / Accessoires (NOT Included) / Accessories (NON Inclus)/ Acessórios (NÃO Incluso)

+ INFO PAG. 328

|        |                           |
|--------|---------------------------|
| 576086 | Cable alimentación Blanco |
| 576116 | Empalme estanco           |

|                   |                |
|-------------------|----------------|
| 210744 * / 576109 | Empalme simple |
| 383929 / 576093   | Conector macho |

|        |            |
|--------|------------|
| 576123 | Tapa final |
| 210751 | Conector L |

|                   |               |
|-------------------|---------------|
| 210768 * / 442749 | Clip sujeción |
|-------------------|---------------|

\*Hasta fin de existencias/\* Until end of stock/\* Jusqu'à épuisement des stocks/\* Enquanto os estoques durarem

# flexiLIGHT Led

## Brite

|           |                 |
|-----------|-----------------|
|           | 230V ac         |
| <b>Hz</b> | 50-60Hz         |
|           | CII             |
|           | 1 Canal/ 2 Vías |
|           | IP44 PLUG       |
|           | IP65            |
|           | 120°            |
|           | -25°C~+60 °C    |
|           | 8,2kg (N.W.)    |
|           | INC.            |
|           | Rollo 50m       |



**N**/ Exterior/Textura Lisa/Tapa final **INCLUIDA**  
**E**/ Outside/Smooth Texture/End cap **INCLUDED**  
**F**/ À L'exterieur/Texture Lisse/Couvercle **INCLUS**  
**P**/ Exterior/Textura Lisa/Tampa final **INCLUÍDA**

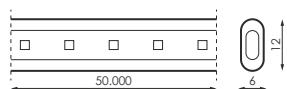
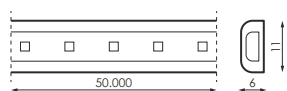

|          |                   |
|----------|-------------------|
|          | 1m                |
|          | 11x6mm<br>*12x6mm |
|          | 60                |
|          | 5,5W<br>*5W       |
| <b>W</b> | 275W<br>*250W     |
|          | Max. 100m         |
|          | Rollo 50m         |

|          |  |  |
|----------|--|--|
|          |  |  |
| 442671   |  |  |
| 442695 * |  |  |
| 563345*  |  |  |
| 563321*  |  |  |
| 588966*  |  |  |

### Accesorios (NO Incluidos) / Accessoires (NOT Included) / Accessories (NON Inclus)/ Acessórios (NÃO Incluso)

+ INFO PAG. 328

|                           |             |                                       |                                       |
|---------------------------|-------------|---------------------------------------|---------------------------------------|
| 442701                    | 442794      | 442725                                | 442732                                |
| Cable alimentación Blanco | Tapa final  | Empalme                               | Empalme estanco                       |
| 442763                    | 442770      | 442800                                | 442817                                |
| Conector L                | Conector X  | Adaptador Smart Link-Flexilight Brite | Adaptador Flexilight Brite-Smart Link |
| 442718                    | 442756      | 442787                                | 442749                                |
| Conector macho            | Canaleta 1m | Extensión 0,5m                        | Clip sujección                        |

\*Hasta fin de existencias/\* Until end of stock/\* Jusqu'à épuisement des stocks/\* Enquanto os estoques durarem

[GRÁFICOS: Unidades en mm/ GRAPHICS: Units in mm/ GRAPHIQUES: Unités en mm/ GRÁFICOS: Unidades em mm]

# flexiLIGHT

## Instant Liso

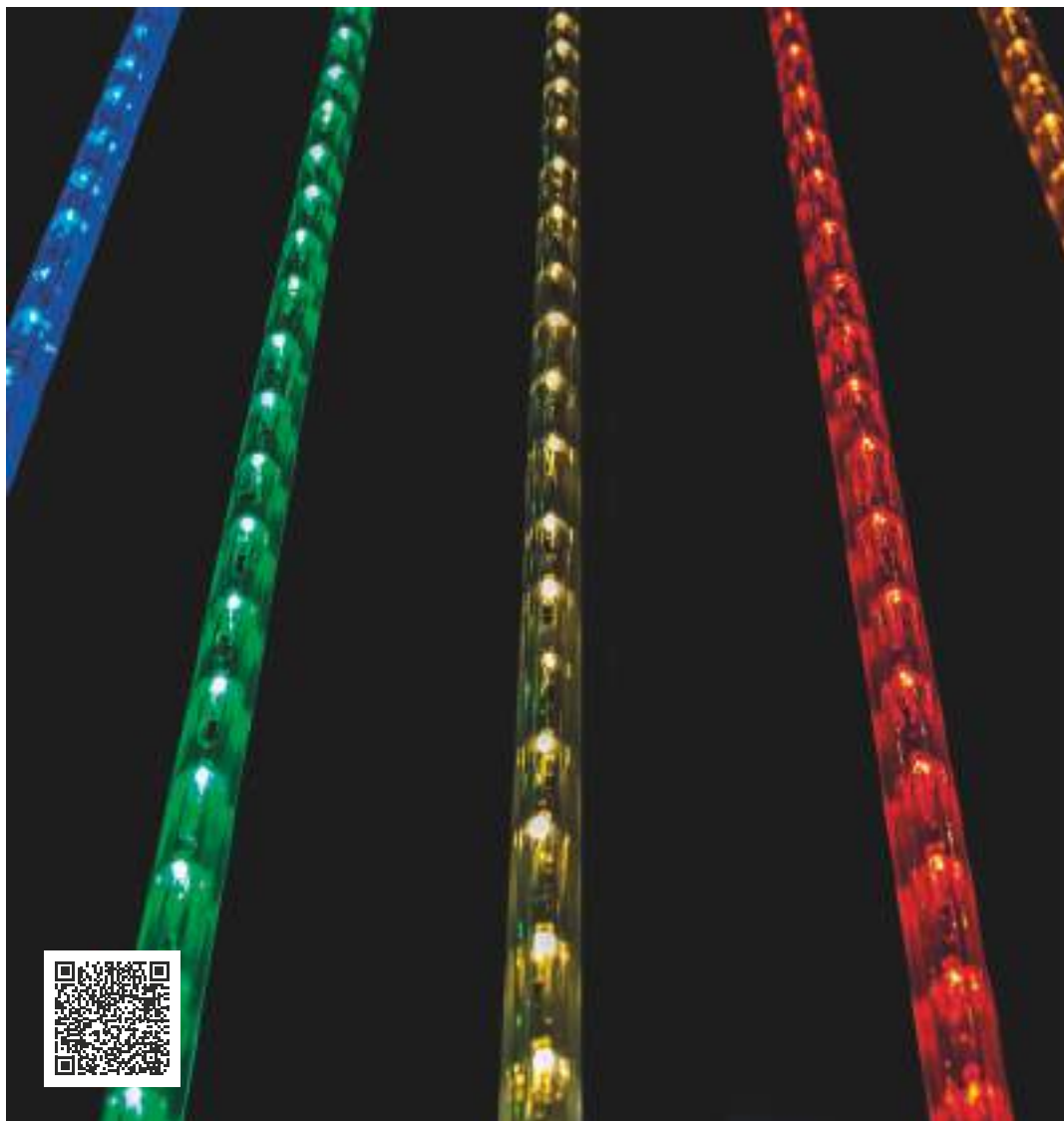

⚡ 230V ac

Hz 50-60Hz

□ CII

⊙ 1 Canal/ 2 Vías

⊙ IP44 PLUG

⊙ IP65

∠ 120°

⊕ -20°C~+60 °C

⊕ INC.

⊕ Rollo 50m

**N**/ Exterior/Textura Lisa/Bombilla fusible  
**E**/ Outside/Smooth Texture/Bulb fuse  
**F**/ À L'exterieur/Texture Lisse/Ampoule fusible  
**P**/ Exterior/Textura Lisa/Fusível de bulbo



|        |  |  |
|--------|--|--|
|        |  |  |
| 002684 |  |  |
| 002691 |  |  |
| 002714 |  |  |
| 002721 |  |  |
| 002707 |  |  |
| 002738 |  |  |

|     |           |
|-----|-----------|
|     | 1m        |
| ∅   | 13mm      |
|     | 36        |
| W/⊕ | 16,56W    |
| W   | 828W      |
|     | Max. 100m |
| ⊕   | Rollo 50m |

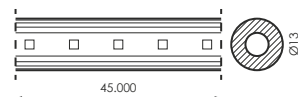

Accesorios (NO Incluidos) / Accessoires (NOT Included) / Accessories (NON Inclus)/ Acessórios (NÃO Incluso)

+ INFO PAG. 328

096744

Cable alimentación Negro

972222









Cable alimentación Blanco sin shucko

972239

Cable alimentación Negro sin shucko

# flexiLIGHT Led

Ø11mm

|   |                   |
|---|-------------------|
|  | 230V ac           |
| <b>Hz</b>   | 50-60Hz           |
|  | CII               |
|  | 1 Canal/ 2 Vías   |
|  | IP44 PLUG<br>IP65 |
|  | 360°              |
|  | -25°C~+60 °C      |
|  | 6kg (N.W.)        |
|  | INC.              |
|  | Rollo 45m         |

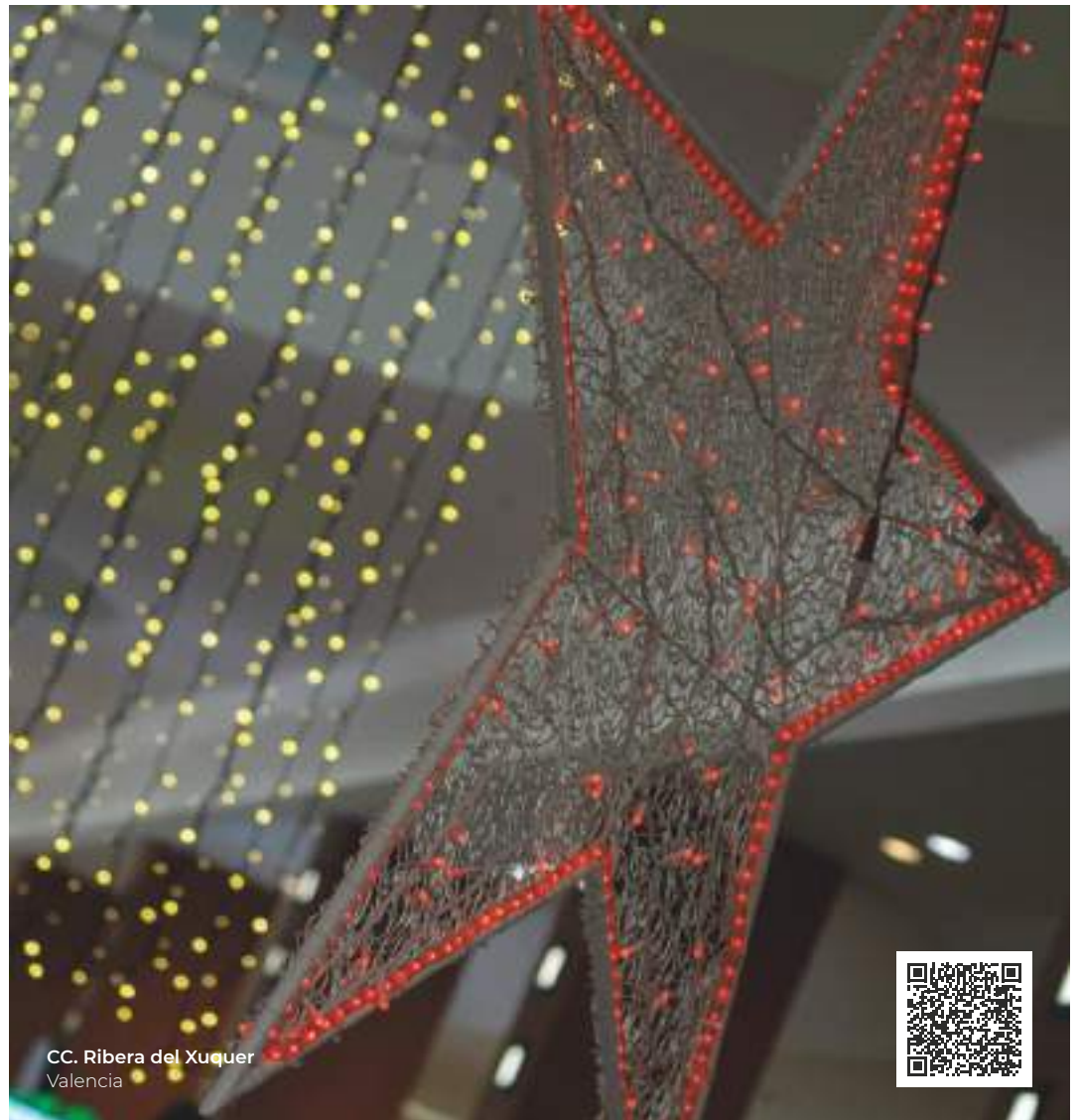







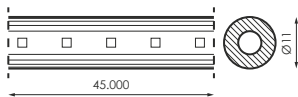













CC. Ribera del Xuquer  
Valencia



**N**/ Exterior/Textura Lisa/Tapa final **INCLUIDA**  
**E**/ Outside/Smooth Texture/End cap **INCLUDED**  
**F**/ À L'exterieur/Texture Lisse/Couvercle **INCLUS**  
**P**/ Exterior/Textura Lisa/Tampa final **INCLUÍDA**



|   |           |   |   |   |
|---|-----------|---|---|---|
|  | 1m        |  |  |  |
|  | 11mm      | 953375  |  |  |
|  | 36        | 191937  |  |  |
|  | 3W        | 953382  |  |  |
| <b>W</b>  | 135W      | 953399  |  |  |
|  | Max. 90m  | 953450  |  |  |
|  | Rollo 45m | 953467  |  |  |

Accesorios (NO Incluidos) / Accessoires (NOT Included) / Accessories (NON Inclus) / Acessórios (NÃO Includo)

+ INFO PAG. 328

953474

Cable alimentación Negro

391542

Cable alimentación Blanco









# Accesorios (NO Incluidos)

Accessoires (NOT Included)

Accessories (NON Inclus)

Acessórios (NÃO Incluso)

|   |  | flexiLIGHT 24V | flexiLIGHT 24V Flashing | flexiLIGHT Bomb. Horizontal | flexiLIGHT Flashing | flexiLIGHT Bomb. Vertical | flexiLIGHT Dual | flexiLIGHT Avant IP67 | flexiLIGHT Chasing | flexiLIGHT Neon | flexiLIGHT Neon 360° | flexiLIGHT Mini Neon Slim | flexiLIGHT Mini Neon | flexiLIGHT Double Neon | flexiLIGHT Double Neon 24V | flexiLIGHT Maxibrillo | flexiLIGHT Bríte | flexiLIGHT Instant | flexiLIGHT Ø11mm |   |
|---|---|----------------|-------------------------|-----------------------------|---------------------|---------------------------|-----------------|-----------------------|--------------------|-----------------|----------------------|---------------------------|----------------------|------------------------|----------------------------|-----------------------|------------------|--------------------|------------------|---|
|   | 006590  |                |                         |                             |                     |                           |                 |                       |                    |                 |                      |                           |                      |                        |                            |                       |                  |                    |                  | • |
|   | 096744  |                |                         |                             |                     |                           |                 |                       |                    |                 |                      |                           |                      |                        |                            |                       |                  |                    | •                |   |
|   | 150330  |                |                         | •                           | •                   | •                         |                 |                       |                    |                 |                      |                           |                      |                        |                            |                       |                  |                    |                  |   |
|   | 210713  |                |                         |                             |                     |                           |                 |                       |                    |                 |                      |                           |                      |                        |                            | •                     |                  |                    |                  |   |
|   | 391542  |                |                         |                             |                     |                           |                 |                       |                    |                 |                      |                           |                      |                        |                            |                       |                  |                    |                  | • |
|   | 442701  |                |                         |                             |                     |                           |                 |                       |                    |                 |                      |                           |                      |                        |                            |                       | •                |                    |                  |   |
|   | 445627  |                |                         |                             |                     |                           |                 |                       |                    | •               |                      |                           |                      |                        |                            |                       |                  |                    |                  |   |
|   | 481687  | •              | •                       |                             |                     |                           |                 |                       | •                  |                 |                      |                           |                      |                        | •                          |                       |                  |                    |                  |   |
|   | 487184  |                |                         |                             |                     |                           |                 | •                     |                    |                 |                      |                           |                      |                        |                            |                       |                  |                    |                  |   |
|   | 487191  |                |                         |                             |                     |                           |                 | •                     |                    |                 |                      |                           |                      |                        |                            |                       |                  |                    |                  |   |
|   | 488440  | •              | •                       |                             |                     |                           |                 |                       | •                  |                 |                      |                           |                      |                        |                            |                       |                  |                    |                  |   |
|   | 488457  | •              | •                       |                             |                     |                           |                 |                       | •                  |                 |                      |                           |                      |                        |                            | •                     |                  |                    |                  |   |
|   | 488464  | •              | •                       |                             |                     |                           |                 |                       | •                  |                 |                      |                           |                      |                        |                            | •                     |                  |                    |                  |   |
|   | 546393  |                |                         |                             |                     |                           |                 |                       |                    |                 | •                    |                           |                      |                        |                            |                       |                  |                    |                  |   |
|   | 546430  |                |                         |                             |                     |                           |                 |                       |                    |                 |                      |                           | •                    |                        |                            |                       |                  |                    |                  |   |
|   | 546478  |                |                         |                             |                     |                           |                 |                       |                    |                 |                      |                           | •                    |                        |                            |                       |                  |                    |                  |   |
|   | 546515  |                |                         |                             |                     |                           |                 |                       |                    |                 |                      |                           |                      | •                      |                            |                       |                  |                    |                  |   |
|   | 571968  | •              | •                       |                             |                     |                           |                 |                       | •                  |                 |                      |                           |                      |                        |                            | •                     |                  |                    |                  |   |
|   | 576086  |                |                         |                             |                     |                           |                 |                       |                    |                 |                      |                           |                      |                        |                            |                       | •                |                    |                  |   |
|   | 952828  |                |                         | •                           | •                   | •                         |                 |                       |                    |                 |                      |                           |                      |                        |                            |                       |                  |                    |                  |   |
| 953474  |   |                |                         |                             |                     |                           |                 |                       |                    |                 |                      |                           |                      |                        |                            |                       |                  |                    |                  | • |
| 972222  |   |                |                         |                             |                     |                           |                 |                       |                    |                 |                      |                           |                      |                        |                            |                       |                  | •                  |                  |   |
| 972239  |   |                |                         |                             |                     |                           |                 |                       |                    |                 |                      |                           |                      |                        |                            |                       |                  | •                  |                  |   |
|  | 391559  |                |                         |                             |                     |                           | •               |                       |                    |                 |                      |                           |                      |                        |                            |                       |                  |                    |                  |   |
|   | 633611  |                |                         |                             |                     |                           |                 |                       | •                  |                 |                      |                           |                      |                        |                            |                       |                  |                    |                  |   |
|   | 971072  |                |                         |                             |                     |                           | •               |                       |                    |                 |                      |                           |                      |                        |                            |                       |                  |                    |                  |   |
|  | 006200  | •              | •                       | •                           | •                   | •                         | •               |                       |                    |                 |                      |                           |                      |                        |                            |                       |                  | •                  |                  |   |
|   | 210768  |                |                         |                             |                     |                           |                 |                       |                    |                 |                      |                           |                      |                        |                            |                       | •                |                    |                  |   |
|   | 442749  |                |                         |                             |                     |                           |                 |                       |                    |                 |                      |                           |                      |                        |                            | •                     |                  |                    |                  |   |
|   | 442756  |                |                         |                             |                     |                           |                 |                       |                    |                 |                      |                           |                      |                        |                            |                       | •                |                    |                  |   |
|   | 445665  |                |                         |                             |                     |                           |                 |                       |                    | •               |                      |                           |                      |                        |                            |                       |                  |                    |                  |   |
|   | 445672  |                |                         |                             |                     |                           |                 |                       |                    | •               |                      |                           |                      |                        |                            |                       |                  |                    |                  |   |
|   | 446761  | •              | •                       | •                           | •                   | •                         | •               |                       |                    |                 |                      |                           |                      |                        |                            |                       |                  | •                  |                  |   |
|   | 546423  |                |                         |                             |                     |                           |                 |                       |                    |                 | •                    |                           |                      |                        |                            |                       |                  |                    |                  |   |
|   | 546461  |                |                         |                             |                     |                           |                 |                       |                    |                 |                      |                           | •                    |                        |                            |                       |                  |                    |                  |   |
|   | 546508  |                |                         |                             |                     |                           |                 |                       |                    |                 |                      |                           | •                    |                        |                            |                       |                  |                    |                  |   |
| 546546  |   |                |                         |                             |                     |                           |                 |                       |                    |                 |                      |                           | •                    |                        |                            |                       |                  |                    |                  |   |
|  | 002776  | •              | •                       | •                           | •                   | •                         | •               |                       |                    |                 |                      |                           |                      |                        |                            |                       |                  | •                  |                  |   |
|   | 006408  | •              | •                       | •                           | •                   | •                         | •               |                       |                    |                 |                      |                           |                      |                        |                            |                       |                  | •                  |                  |   |
|   | 006941  | •              | •                       | •                           | •                   | •                         | •               |                       |                    |                 |                      |                           |                      |                        |                            |                       |                  | •                  |                  |   |
|   | 010818  |                |                         | •                           | •                   | •                         | •               |                       |                    |                 |                      |                           |                      |                        |                            |                       |                  | •                  |                  |   |

|  |  | flexiLIGHT 24V | flexiLIGHT 24V Flashing | flexiLIGHT Bomb. Horizontal | flexiLIGHT Flashing | flexiLIGHT Bomb. Vertical | flexiLIGHT Dual | flexiLIGHT Avant IP67 | flexiLIGHT Chasing | flexiLIGHT Neon | flexiLIGHT Neon 360° | flexiLIGHT Mini Neon Slim | flexiLIGHT Mini Neon | flexiLIGHT Double Neon | flexiLIGHT Double Neon 24V | flexiLIGHT Maxibrillo | flexiLIGHT Brité | flexiLIGHT Instant | flexiLIGHT Ø11mm |
|--|---|----------------|-------------------------|-----------------------------|---------------------|---------------------------|-----------------|-----------------------|--------------------|-----------------|----------------------|---------------------------|----------------------|------------------------|----------------------------|-----------------------|------------------|--------------------|------------------|
|  | 064354  | •              | •                       | •                           | •                   | •                         | •               |                       |                    |                 |                      |                           |                      |                        |                            |                       |                  | •                  |                  |
|  | 064729  | •              | •                       | •                           | •                   | •                         | •               |                       |                    |                 |                      |                           |                      |                        |                            |                       |                  | •                  |                  |
|  | 068017  |                |                         |                             |                     |                           |                 |                       |                    |                 |                      |                           |                      |                        |                            |                       |                  |                    | •                |
|  | 068048  |                |                         |                             |                     |                           |                 |                       |                    |                 |                      |                           |                      |                        |                            |                       |                  |                    | •                |
|  | 084727  | •              | •                       | •                           | •                   | •                         | •               |                       |                    |                 |                      |                           |                      |                        |                            |                       |                  | •                  |                  |
|  | 097109  | •              | •                       | •                           | •                   | •                         | •               | •                     |                    |                 |                      |                           |                      |                        |                            |                       |                  | •                  | •                |
|  | 194556  | •              | •                       |                             |                     |                           | •               |                       |                    |                 |                      |                           |                      |                        |                            |                       |                  |                    |                  |
|  | 210744  |                |                         |                             |                     |                           |                 |                       |                    |                 |                      |                           |                      |                        |                            | •                     |                  |                    |                  |
|  | 210751  |                |                         |                             |                     |                           |                 |                       |                    |                 |                      |                           |                      |                        |                            | •                     |                  |                    |                  |
|  | 236010  | •              | •                       | •                           | •                   | •                         | •               |                       |                    |                 |                      |                           |                      |                        |                            |                       |                  | •                  |                  |
|  | 383929  |                |                         |                             |                     |                           |                 |                       |                    |                 |                      |                           |                      |                        |                            | •                     |                  |                    |                  |
|  | 388405  | •              | •                       | •                           | •                   | •                         | •               |                       |                    |                 |                      |                           |                      |                        |                            |                       |                  | •                  |                  |
|  | 388559  |                |                         |                             |                     |                           |                 |                       |                    |                 |                      |                           |                      |                        |                            |                       |                  |                    | •                |
|  | 398121  |                |                         |                             |                     |                           |                 |                       |                    |                 |                      |                           |                      |                        |                            |                       |                  |                    | •                |
|  | 442718  |                |                         |                             |                     |                           |                 |                       |                    |                 |                      |                           |                      |                        |                            |                       | •                |                    |                  |
|  | 442725  |                |                         |                             |                     |                           |                 |                       |                    |                 |                      |                           |                      |                        |                            |                       | •                |                    |                  |
|  | 442732  |                |                         |                             |                     |                           |                 |                       |                    |                 |                      |                           |                      |                        |                            |                       | •                |                    |                  |
|  | 442763  |                |                         |                             |                     |                           |                 |                       |                    |                 |                      |                           |                      |                        |                            |                       | •                |                    |                  |
|  | 442770  |                |                         |                             |                     |                           |                 |                       |                    |                 |                      |                           |                      |                        |                            |                       | •                |                    |                  |
|  | 442787  |                |                         |                             |                     |                           |                 |                       |                    |                 |                      |                           |                      |                        |                            |                       | •                |                    |                  |
|  | 442800  |                |                         |                             |                     |                           |                 |                       |                    |                 |                      |                           |                      |                        |                            |                       | •                |                    |                  |
|  | 442817  |                |                         |                             |                     |                           |                 |                       |                    |                 |                      |                           |                      |                        |                            |                       | •                |                    |                  |
|  | 445634  |                |                         |                             |                     |                           |                 |                       |                    | •               |                      |                           |                      |                        |                            |                       |                  |                    |                  |
|  | 445641  |                |                         |                             |                     |                           |                 |                       |                    | •               |                      |                           |                      |                        |                            |                       |                  |                    |                  |
|  | 445689  |                |                         |                             |                     |                           |                 |                       |                    | •               |                      |                           |                      |                        |                            |                       |                  |                    |                  |
|  | 518611  |                |                         |                             |                     |                           |                 |                       |                    |                 |                      |                           |                      |                        | •                          |                       |                  |                    |                  |
|  | 518635  |                |                         |                             |                     |                           |                 |                       |                    |                 |                      |                           |                      |                        | •                          |                       |                  |                    |                  |
|  | 523615  |                |                         |                             |                     |                           |                 |                       |                    |                 |                      |                           |                      |                        | •                          |                       |                  |                    |                  |
|  | 523622  |                |                         |                             |                     |                           |                 |                       |                    |                 |                      |                           |                      |                        | •                          |                       |                  |                    |                  |
|  | 523639  |                |                         |                             |                     |                           |                 |                       |                    |                 |                      |                           |                      |                        |                            |                       |                  |                    |                  |
|  | 546409  |                |                         |                             |                     |                           |                 |                       |                    | •               |                      |                           |                      |                        |                            |                       |                  |                    |                  |
|  | 546447  |                |                         |                             |                     |                           |                 |                       |                    |                 |                      |                           | •                    |                        |                            |                       |                  |                    |                  |
|  | 546485  |                |                         |                             |                     |                           |                 |                       |                    |                 |                      |                           |                      |                        |                            |                       |                  |                    |                  |
|  | 546522  |                |                         |                             |                     |                           |                 |                       |                    |                 |                      |                           |                      |                        | •                          |                       |                  |                    |                  |
|  | 566377  |                |                         |                             |                     |                           |                 |                       |                    |                 |                      |                           |                      |                        |                            |                       |                  |                    |                  |
|  | 576093  |                |                         |                             |                     |                           |                 |                       |                    |                 |                      |                           |                      |                        |                            |                       |                  | •                  |                  |
|  | 576109  |                |                         |                             |                     |                           |                 |                       |                    |                 |                      |                           |                      |                        |                            |                       |                  | •                  |                  |
|  | 576116  |                |                         |                             |                     |                           |                 |                       |                    |                 |                      |                           |                      |                        |                            |                       |                  | •                  |                  |
|  | 599870  |                |                         |                             |                     |                           |                 |                       |                    |                 |                      |                           |                      |                        | •                          |                       |                  |                    |                  |
|  | 600910  |                |                         |                             |                     |                           |                 |                       |                    |                 |                      |                           |                      |                        | •                          |                       |                  |                    |                  |
|  | 600934  |                |                         |                             |                     |                           |                 |                       |                    |                 |                      |                           |                      |                        | •                          |                       |                  |                    |                  |
|  | 601511  |                |                         |                             |                     |                           |                 |                       |                    |                 |                      |                           |                      |                        | •                          |                       |                  |                    |                  |
|  | 633628  |                |                         |                             |                     |                           |                 |                       |                    | •               |                      |                           |                      |                        |                            |                       |                  |                    |                  |
|  | 633635  |                |                         |                             |                     |                           |                 |                       |                    | •               |                      |                           |                      |                        |                            |                       |                  |                    |                  |
|  | 633666  |                |                         |                             |                     |                           |                 |                       |                    | •               |                      |                           |                      |                        |                            |                       |                  |                    |                  |
|  | 971195  |                |                         |                             |                     |                           |                 |                       |                    |                 |                      |                           |                      |                        |                            |                       |                  | •                  |                  |
|  | 971201  |                |                         |                             |                     |                           |                 |                       |                    |                 |                      |                           |                      |                        |                            |                       |                  | •                  |                  |
|  | 971218  |                |                         |                             |                     |                           |                 |                       |                    |                 |                      |                           |                      |                        |                            |                       |                  | •                  |                  |
|  | 001717  |                |                         |                             |                     |                           |                 |                       |                    |                 |                      |                           |                      |                        |                            |                       |                  |                    | •                |
|  | 011853  |                |                         | •                           | •                   | •                         |                 |                       |                    |                 |                      |                           |                      |                        |                            |                       |                  | •                  |                  |

|        | flexiLIGHT 24V | flexiLIGHT 24V Flashing | flexiLIGHT Bomb. Horizontal | flexiLIGHT Flashing | flexiLIGHT Bomb. Vertical | flexiLIGHT Dual | flexiLIGHT Avant IP67 | flexiLIGHT Chasing | flexiLIGHT Neon | flexiLIGHT Neon 360° | flexiLIGHT Mini Neon Slim | flexiLIGHT Mini Neon | flexiLIGHT Double Neon | flexiLIGHT Double Neon 24V | flexiLIGHT Maxibrillo | flexiLIGHT Brite | flexiLIGHT Instant | flexiLIGHT Ø11mm |
|--------|----------------|-------------------------|-----------------------------|---------------------|---------------------------|-----------------|-----------------------|--------------------|-----------------|----------------------|---------------------------|----------------------|------------------------|----------------------------|-----------------------|------------------|--------------------|------------------|
| 442794 |                |                         |                             |                     |                           |                 |                       |                    |                 |                      |                           |                      |                        |                            |                       |                  |                    |                  |
| 445658 |                |                         |                             |                     |                           |                 |                       |                    | •               |                      |                           |                      |                        |                            |                       |                  |                    |                  |
| 546416 |                |                         |                             |                     |                           |                 |                       |                    |                 | •                    |                           |                      |                        |                            |                       |                  |                    |                  |
| 546454 |                |                         |                             |                     |                           |                 |                       |                    |                 |                      |                           | •                    |                        |                            |                       |                  |                    |                  |
| 546492 |                |                         |                             |                     |                           |                 |                       |                    |                 |                      |                           |                      |                        |                            |                       |                  |                    |                  |
| 546539 |                |                         |                             |                     |                           |                 |                       |                    |                 |                      |                           |                      | •                      |                            |                       |                  |                    |                  |
| 576123 |                |                         |                             |                     |                           |                 |                       |                    |                 |                      |                           |                      |                        |                            |                       |                  |                    |                  |
| 600927 |                |                         |                             |                     |                           |                 |                       |                    |                 |                      |                           |                      |                        | •                          |                       |                  |                    |                  |
| 633642 |                |                         |                             |                     |                           |                 |                       | •                  |                 |                      |                           |                      |                        |                            |                       |                  |                    |                  |

### FUENTE ALIMENTACIÓN 24V

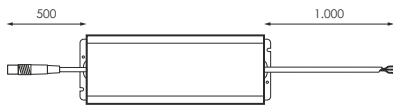

|        | IN       | W   | IP   | Plug       | Dimensions      | Outputs   |
|--------|----------|-----|------|------------|-----------------|-----------|
| 488440 | 170-240V | 24V | 30W  | IP66/ IP44 | 202 x 34 x 36mm | 1 salida  |
| 488457 | 170-240V | 24V | 60W  | IP66/ IP44 | 197 x 45 x 32mm | 1 salida  |
| 488464 | 170-240V | 24V | 100W | IP66/ IP44 | 248 x 45 x 32mm | 1 salida  |
| 481687 | 100-240V | 24V | 150W | IP66/ IP44 | 230 x 63 x 39mm | 1 salida  |
| 571968 | 100-240V | 24V | 200W | IP66/ IP44 | 260 x 73 x 45mm | 2 salidas |

### ADAPTADOR 24V/DUAL

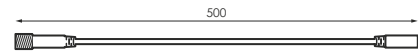

| Code     | Icon | Description  |
|----------|------|--|
| 194556   |      | Adaptador del rectificador a Flexilight Led<br>Adapter of rectifier to Flexilight Led  |
| N 634618 |      | Adaptateur redresseur à Flexilight Led<br>Adaptador de retificador para Flexilight Led |

### ADAPTADOR DUAL/24V

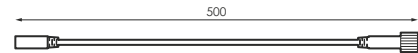

| Code     | Icon | Description   |
|----------|------|---|
| N 634625 |      | Adaptador del Flexilight Led a 24V<br>Adapter of Flexilight Led to 24V  |
| N 634632 |      | Adaptateur Flexilight Led à 24V<br>Adaptador de Flexilight Led para 24V |

### CABLE ALIMENTACIÓN Ø13mm

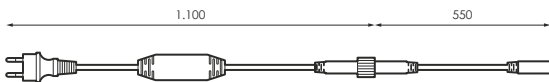

| Code   | Icon | Voltage | Power     | Class | Plug/Connector             |
|--------|------|---------|-----------|-------|----------------------------|
| 952828 |      | 230Vac  | Max. 480W | CII   | IP44 Plug<br>IP65 Conector |
| 150330 |      | 230Vac  | Max. 480W | CII   | IP44 Plug<br>IP65 Conector |

### CABLE ALIMENTACIÓN

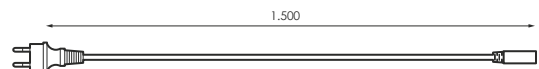

| Code   | Description                |
|--------|----------------------------|
| 096744 | FLEXILIGHT 13mm            |
| 006590 | FLEXILIGHT 11mm Horizontal |

### CABLE ALIMENTACIÓN Ø13mm

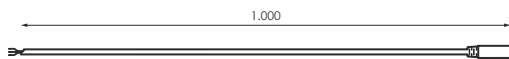

| Code   | Icon | Voltage | Class |
|--------|------|---------|-------|
| 972239 |      | 230V    | CII   |
| 972222 |      | 230V    | CII   |

### CONECTOR Y

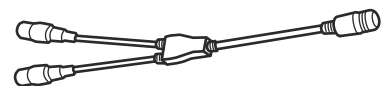

| Code   | Description                   |
|--------|-------------------------------|
| 084727 | Flexilight 13mm. PVC. 1 Canal |

**CONECTOR X**

PVC/1 canal

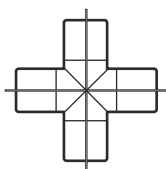

068048

Flexilight 11mm

**CONECTOR T**

PVC/1 canal

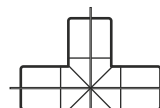

064729

Flexilight 13mm

006408

Flexilight 13mm

**EXTENSIÓN**

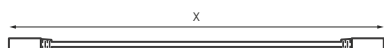

388405

Empalme simple 0,5m 13mm 1canal  
Simple joint 0,5m 1cannal 13mm  
Articulation simple 0,5m 1canal 13mm  
Junção simples 0,5m 13mm 1canal

236010

Empalme simple 1m 13mm 1canal  
Simple joint 1m 1cannal 13mm  
Articulation simple 1m 1canal 13mm  
Junção simples 1m 13mm 1canal

006941

Empalme simple 3m 13mm 1canal  
Simple joint 3m 1cannal 13mm  
Articulation simple 3m 1canal 13mm  
Junção simples 3m 13mm 1canal

Termorretractil y conector macho **NO INCLUIDOS**  
Heat-shrinkable and male connector **NOT INCLUDED**  
Thermorétractable et connecteur mâle **NON INCLUS**  
Tubo de contração térmica e conector macho **NÃO INCLUIDO**

**TERMORRETRACTIL**

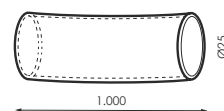

097109

Ø19,1mm para Flexilight. Recubrimiento interior de resina termoplástica. Rollo 1m.  
Ø19,1mm for Flexilight. Thermoplastic resin inner lining. Roll 1m.  
Ø19,1mm pour Flexilight. Doublure intérieure en résine thermoplastique. Rouler 1m.  
Ø19,1mm para Flexilight. Revestimento interno em resina termoplástica. Roll 1m.

**EMPALME ESTANCO**

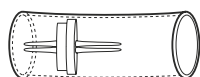

010818

Flexilight 13mm

068017

Flexilight 11mm

**CONECTOR MACHO**

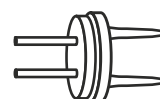

388559

Flexilight 11mm

064354

Flexilight 13mm

**EMPALME SENCILLO**

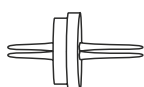

002776

Flexilight 13mm

398121

Flexilight 11mm

**TAPA FINAL**

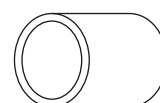

011853

Flexilight 13mm

001717

Flexilight 11mm



CLIP SUJECCIÓN

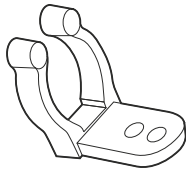

446761

Flexilight 13mm

CANALETA Ø13mm



006200

2m



T

Transparente

CONTROLADOR DUAL

2A

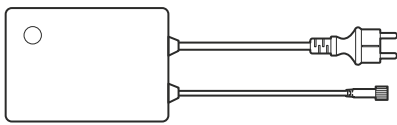

391559



230V

W

Max. 240W

8 funciones efecto memoria  
8 functions memory effect  
8 fonctions effet mémoire  
8 funções efeito de memória

CONTROLADOR DUAL

6A

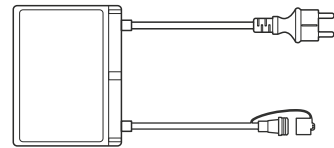

971072



230V

W

Max. 1.200W



\*Max. 240m

\*Máx. 240m (máx. 90m por salida)/ 4 funciones  
\*Max. 240m (max. 90m per output)/ 4 functions  
\*Max. 240m (max. 90m par sortie)/ 4 fonctions  
\*Max. 240m (max. 90m por saída)/ 4 funções

CONECTOR DUAL

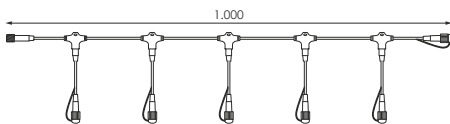

971201

5 Portalámparas (1m)  
5 Lampholders (1m)  
5 Douilles (1m)  
5 Portalâmpadas (1m)

CONECTOR DUAL

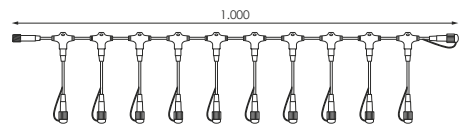

971195

10 Portalámparas (1m)  
10 Lampholders (1m)  
10 Douilles (1m)  
10 Portalâmpadas (1m)

CONECTOR DUAL

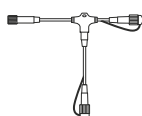

971218

Conector T  
Connector T  
Connecteur en T  
Conector em T

CABLE ALIMENTACIÓN AVANT Ø13mm

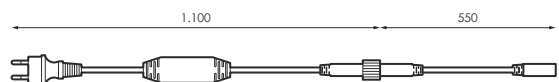

487184



230Vac

W

Max. 480W



CII



IP44 Plug

IP67 Conector

487191



230Vac

Max. 480W

CII

IP44 Plug

IP67 Conector

CONTROLADOR CHASING

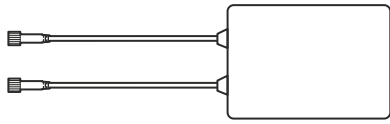

**N 633611**



24V

W

Max. 30M/  
controlador

4 funciones efecto memoria  
4 functions memory effect  
4 fonctions effet mémoire  
4 funções efeito de memória

ADAPTADOR CHASING

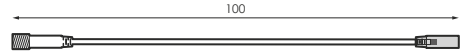

**N 633666**

Adaptador Flexilight Led a conector macho  
Adapter Flexilight Led to male connector  
Adaptateur Flexilight Led vers connecteur mâle  
Adaptador Flexilight Led para conector macho

CONECTOR 5 CHASING

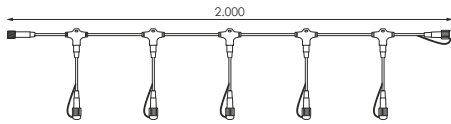

**N 633635**

5 Portalámparas (2m)  
5 Lampholders (2m)  
5 Douilles (2m)  
5 Portalâmpadas (2m)

CONECTOR T CHASING

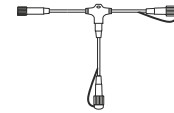

**N 633628**

Conector T  
Connector T  
Connecteur en T  
Conector em T

TAPA FINAL CHASING

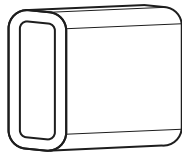

**N 633642**

Flexilight Chasing

CABLE ALIMENTACIÓN NEON

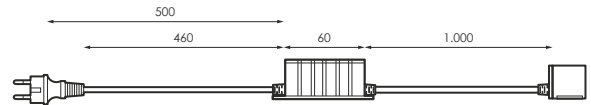

**445627**



230Vac/dc

W

Max. 600W



IP44 Plug  
IP66 Conector

EMPALME L NEON

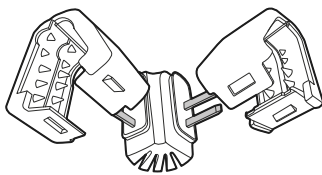

**445641**



Transparente

EMPALME SENCILLO NEON

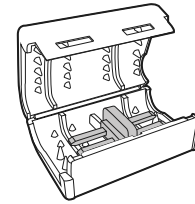

**445634**



Transparente

TAPA FINAL NEON

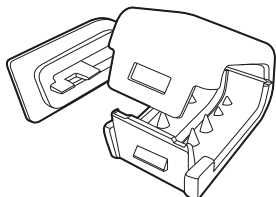

**445658**



Transparente

CLIP SUJECCIÓN NEON

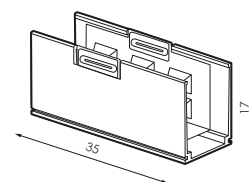

**445672**



Aluminio

CANALETA NEON

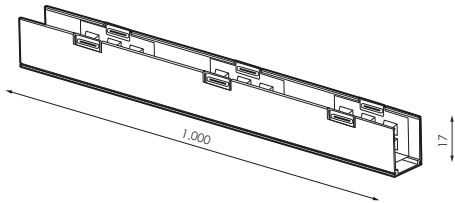

445665



Aluminio

PEGAMENTO NEON

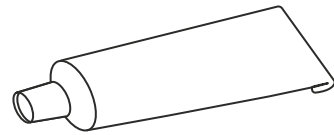

445689

CABLE ALIMENTACIÓN NEON 360°

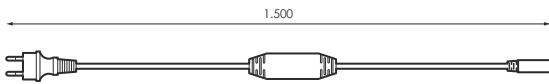

546393



230Vac/dc



IP44 Plug  
IP65 Conector

EMPALME NEON 360°

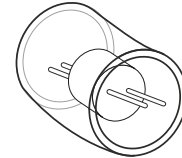

546409



Blanco

CLIP SUJECCIÓN NEON 360°

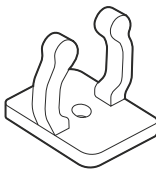

546423



Transparente

TAPA FINAL NEON 360°

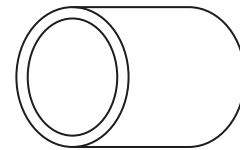

546416



Transparente

CABLE ALIMENTACIÓN MINI NEON SLIM

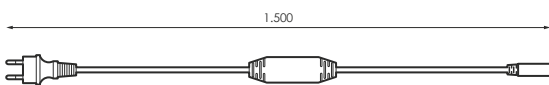

546478



230Vac/dc



IP44 Plug  
IP65 Conector

EMPALME MINI NEON SLIM

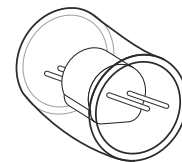

546485



Blanco

CLIP SUJECCIÓN MINI NEON SLIM

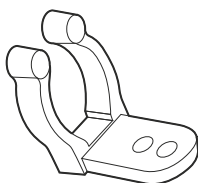

546508



Transparente

TAPA FINAL MINI NEON SLIM

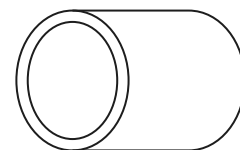

546492



Transparente

CABLE ALIMENTACIÓN MINI NEON

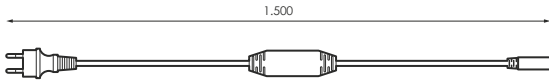

546430



230Vac/dc



IP44 Plug  
IP54 Conector

EMPALME MINI NEON

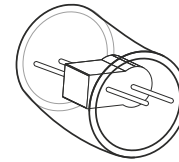

546447



BI

Blanco

CLIP SUJECCIÓN MINI NEON

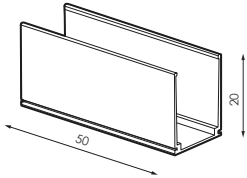

546461



A

Aluminio

TAPA FINAL MINI NEON

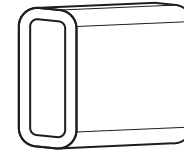

546454



T

Transparente

CABLE ALIMENTACIÓN DOUBLE NEON

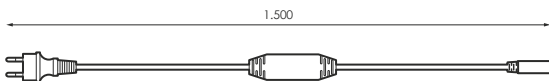

546515



230Vac/dc



IP44 Plug  
IP65 Conector

EMPALME DOUBLE NEON

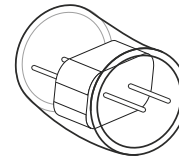

546522



BI

Blanco

CLIP SUJECCIÓN DOUBLE NEON

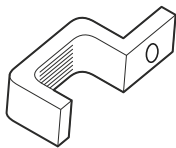

546546



T

Transparente

TAPA FINAL DOUBLE NEON

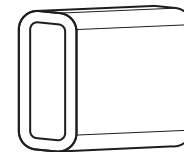

546539



T

Transparente

ADAPTADOR SMART LINK-FLEXILIGHT DOUBLE NEON

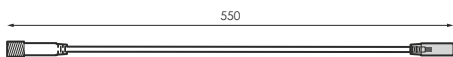

518635



BI

Blanco

ADAPTADOR FLEXILIGHT DOUBLE NEON-SMART LINK

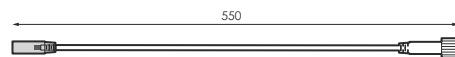

523615



BI

Blanco



EMALME SENCILLO DOUBLE NEON

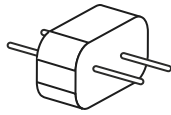

523639



Transparente

CONECTOR MACHO DOUBLE NEON

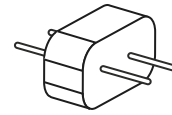

518611



Transparente

EXTENSIÓN DOUBLE NEON

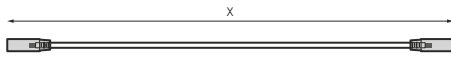

523622



0,5m



Blanco

566377

1m



Blanco

ADAPTADOR FUENTE 24V - FLEXILIGHT DOUBLE NEON 24V

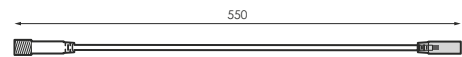

599870



Blanco

TAPA FINAL DOUBLE NEON 24V

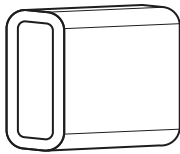

600927



Transparente

EMPALME DOUBLE NEON 24V

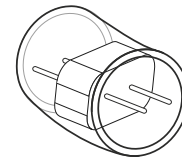

600934



Blanco

CONECTOR MACHO DOUBLE NEON 24V

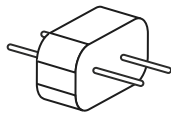

601511



Transparente

ADAPTADOR FLEXILIGHT DOUBLE NEON 24V - 24V

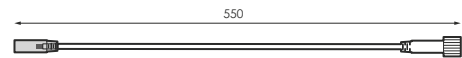

600910



Blanco

CABLE ALIMENTACIÓN MAXIBRILLO

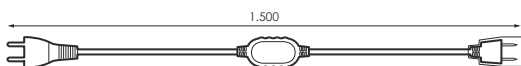

576086



230Vac



Max. 480W

W



IP44 Plug  
IP65 Conector

EMPALME ESTANCO MAXIBRILLO

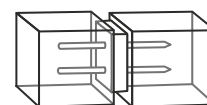

576116



Transparente

CLIP SUJECCIÓN MAXIBRILLO

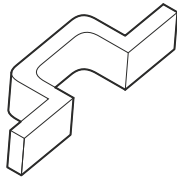

210768



Transparente

CONECTOR L MAXIBRILLO

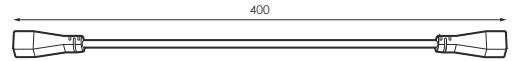

210751



Blanco

EMPALME SIMPLE MAXIBRILLO

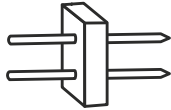

576109



Transparente

210744



Transparente

CONECTOR MACHO MAXIBRILLO

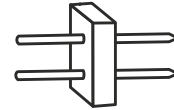

576093



Transparente

383929



Transparente

TAPA FINAL MAXIBRILLO

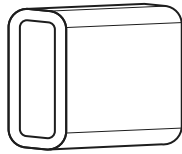

576123



Transparente

CABLE ALIMENTACIÓN BRITE

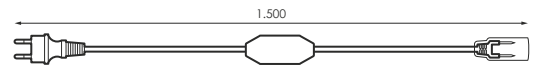

442701



230Vac



Max. 480W



IP44 Plug  
IP66 Conector

EXTENSIÓN BRITE

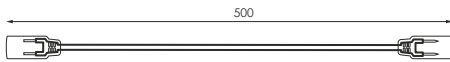

442787



Blanco

ADAPTADOR FLEXILIGHT BRITE-SMART LINK

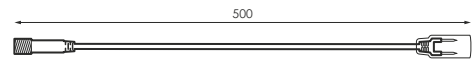

442817



Blanco

ADAPTADOR SMART LINK-FLEXILIGHT BRITE

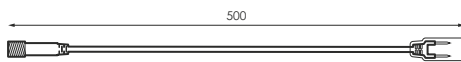

442800



Blanco

CONECTOR L BRITE

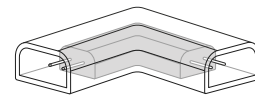

442763



Transparente

CONECTOR X BRITE

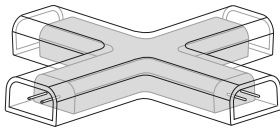

442770



Transparente

EMPALME BRITE

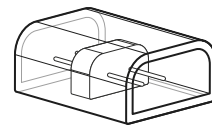

442732



Transparente

EMPALME SENCILLO BRITE

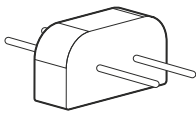

442725



Transparente

CONECTOR MACHO BRITE

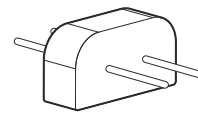

442718



Transparente

TAPA FINAL BRITE

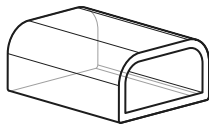

442794



Transparente

CLIP SUJECCIÓN BRITE/MAXIBRILLO

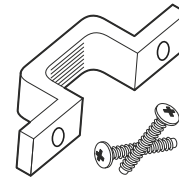

442749



Transparente

CANALETA BRITE



442756



1m



Transparente

CABLE ALIMENTACIÓN Ø11mm

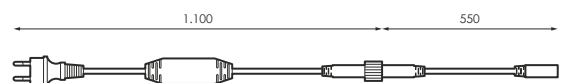

953474



230Vac

Max. 480W



CII



IP44 Plug

IP65 Conector

391542



230Vac

Max. 480W



CII

IP44 Plug

IP65 Conector



San Juan de la Rambla  
Tenerife







minimalist



# STRING PLUS 100

Exterior



La Matanza de Acentejo  
Tenerife

|           |              |
|-----------|--------------|
|           | 230V dc      |
| <b>Hz</b> | 50-60Hz      |
|           | CII          |
|           | 1 CANAL      |
|           | IP65         |
|           | -20°C~+60 °C |
|           | 0,9kg (N.W.) |
|           | NO INC.      |
|           | 10ud         |

| 546690 |  |  |  |
|--------|--|--|--|
| 546706 |  |  |  |
| 546713 |  |  |  |
| 546720 |  |  |  |
| 546737 |  |  |  |
| 546744 |  |  |  |
| 546751 |  |  |  |
| 546768 |  |  |  |
| 546775 |  |  |  |
| 546782 |  |  |  |

|          |                    |
|----------|--------------------|
|          | 10m<br>(5m x 2seg) |
|          | 5m                 |
|          | 100                |
|          | 50                 |
| <b>W</b> | 8W                 |
|          | 4W                 |
|          | 100m               |

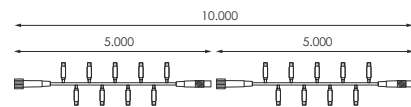

ESQUEMA INSTALACIÓN/  
INSTALLATION SCHEME/  
SCHEMA D'INSTALLATION/  
ESQUEMA DE  
INSTALAÇÃO



+

Producto/Product  
Produit/Produto

Accesorios (NO Incluidos) / Accessoires (NOT Included) / Accessories (NON Inclus) / Acessórios (NÃO Incluso)

+ INFO PAG. 366

995092

Cable alimentación Negro

977722

Cable alimentación Blanco



# STRING **PLUS** 100 Flashing

Exterior

|           |              |
|-----------|--------------|
|           | 230V dc      |
| <b>Hz</b> | 50-60Hz      |
|           | CII          |
|           | 1 CANAL      |
|           | IP65         |
|           | -20°C~+60 °C |
|           | 0,9kg (N.W.) |
|           | NO INC.      |
|           | 10ud         |



SMART  
LINK

Los Silos  
Santa Cruz de Tenerife

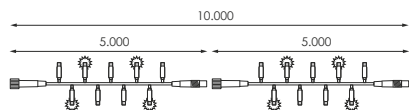

ESQUEMA INSTALACIÓN/  
INSTALLATION SCHEME/  
SCHEMA D'INSTALLATION/  
ESQUEMA DE  
INSTALAÇÃO



Producto/Product  
Produit/Produto

|          |                    |
|----------|--------------------|
|          | 10m<br>(5m x 2seg) |
|          | 5m                 |
|          | 100                |
|          | 40+10<br>flashing  |
| <b>W</b> | 8W                 |
|          | 4W                 |
|          | 100m               |

|        |  |  |
|--------|--|--|
|        |  |  |
| 546799 |  |  |
| 546805 |  |  |
| 546812 |  |  |
| 546829 |  |  |

Accesorios (NO Incluidos) / Accessoires (NOT Included) / Accessories (NON Inclus) / Acessórios (NÃO Incluso)

+ INFO PAG. 366

995092

Cable alimentación Negro

977722

Cable alimentación Blanco











# SCREENLIGHT 100

Exterior















SMART LINK 

|   |              |
|---|--------------|
|  | 230V dc      |
| Hz  | 50-60Hz      |
|  | CII          |
|  | 1 CANAL      |
|  | IP65         |
|  | -20°C~+60 °C |
|  | 1kg (N.W.)   |
|  | NO INC.      |
|  | 10ud         |



Ciudad de Braga 2020  
by AM Illumination  
Producto Prilux

|   |   |   |
|---|---|---|
|  |  |  |
| 503969  |  |  |
| 503976  |  |  |

|   |        |
|---|--------|
|  | 2x1m   |
|  | 20     |
|  | 2      |
|  | 100    |
|  | 5      |
| W   | 7,7W   |
|  | 10sets |

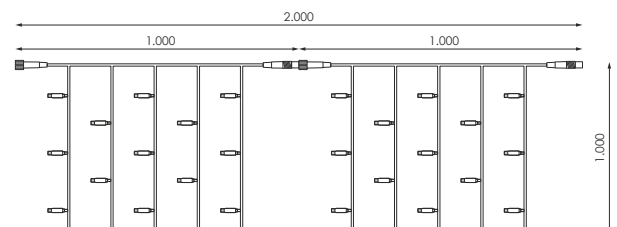

ESQUEMA INSTALACIÓN/  
INSTALLATION SCHEME/  
SCHEMA D'INSTALLATION/  
ESQUEMA DE  
INSTALAÇÃO



+

Producto/Product  
Produit/Produto

Accesorios (NO Incluidos) / Accessoires (NOT Included) / Accessories (NON Inclus) / Acessórios (NÃO Includo)









+ INFO PAG. 366

995092  
Cable alimentación Negro

977722  
Cable alimentación Blanco

# SCREENLIGHT 150

Exterior

|   |              |
|---|--------------|
|  | 230V dc      |
| <b>Hz</b>   | 50-60Hz      |
|  | CII          |
|  | 1 CANAL      |
|  | IP65         |
|  | -20°C~+60 °C |
|  | 1,5kg (N.W.) |
|  | NO INC.      |
|  | 10ud         |



SMART LINK 

Rugat  
Valencia



[GRÁFICOS: Unidades en mm/ GRÁFICOS: Units in mm/ GRAPHICS: Units in mm/ GRÁFICOS: Unidades em mm]

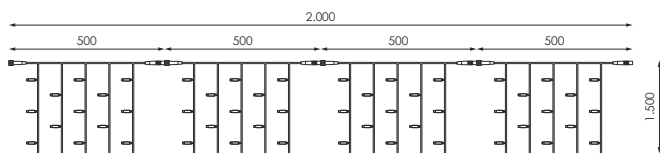













ESQUEMA INSTALACIÓN/  
INSTALLATION SCHEME/  
SCHEMA D'INSTALLATION/  
ESQUEMA DE  
INSTALAÇÃO



+

Producto/Product  
Produit/Produto

|   |        |   |   |   |
|---|--------|---|---|---|
|  | 2x1,5m |  |  |  |
|  | 20     | 503990  |  |  |
|  | 4      | 504003  |  |  |
|  | 150    |   |   |   |
|  | 7/8    |   |   |   |
| <b>W</b>  | 15W    |   |   |   |
|  | 10sets |   |   |   |

Accesorios (NO Incluidos) / Accessoires (NOT Included) / Accessories (NON Includo) / Acessórios (NÃO Includo)

+ INFO PAG. 366

995092

Cable alimentación Negro







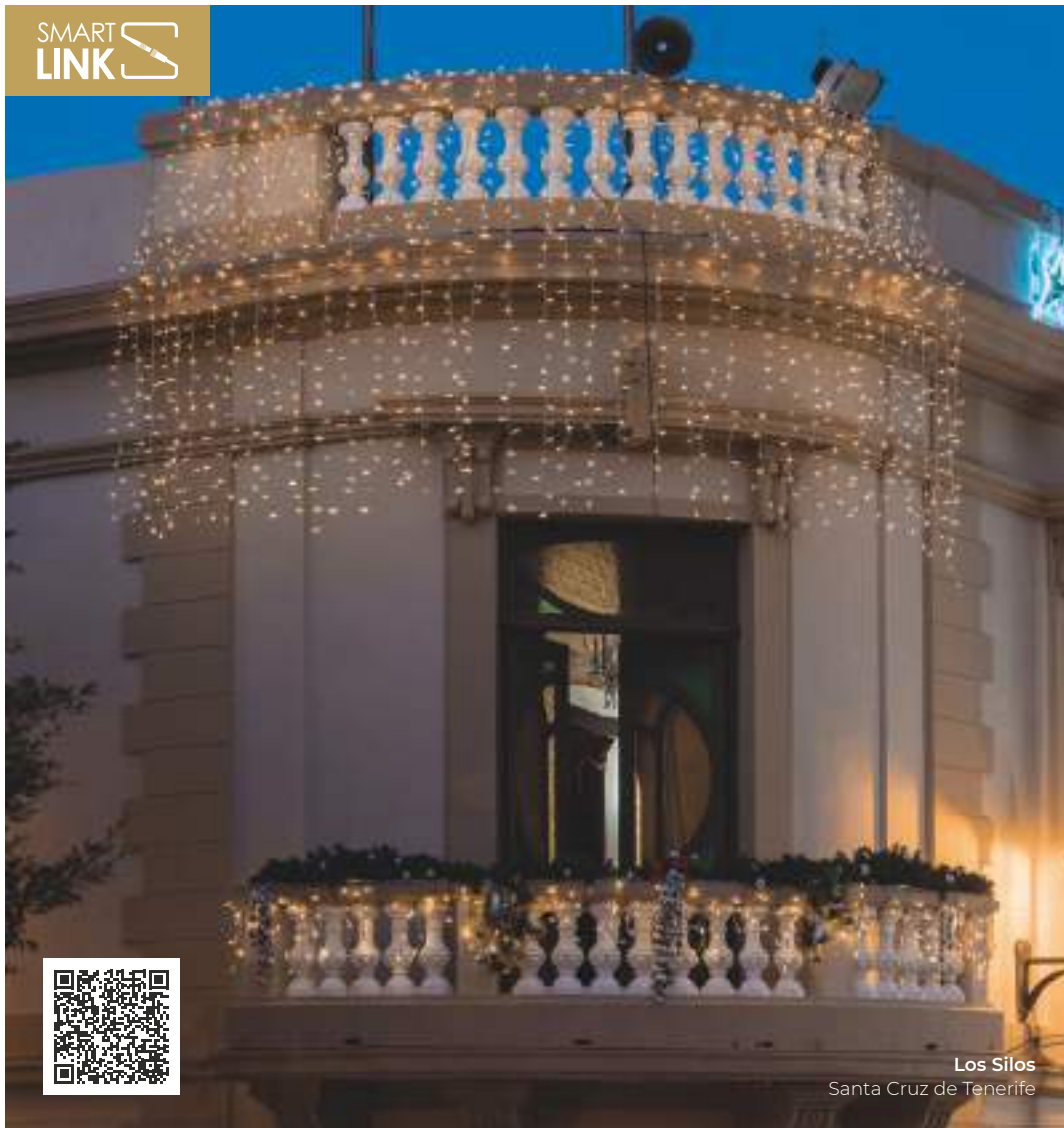

977722







Cable alimentación Blanco







# SCREENLIGHT 300

Exterior



|   |              |
|---|--------------|
|  | 230V dc      |
| <b>Hz</b>   | 50-60Hz      |
|  | CII          |
|  | 1 CANAL      |
|  | IP65         |
|  | -20°C~+60 °C |
|  | 3kg (N.W.)   |
|  | NO INC.      |
|  | 10ud         |

|   |   |   |
|---|---|---|
|  |  |  |
| 504010  |  |  |
| 561471  |  |  |

|   |       |
|---|-------|
|  | 2x3m  |
|  | 20    |
|  | 4     |
|  | 300   |
|  | 15    |
| <b>W</b>  | 15W   |
|  | 7sets |

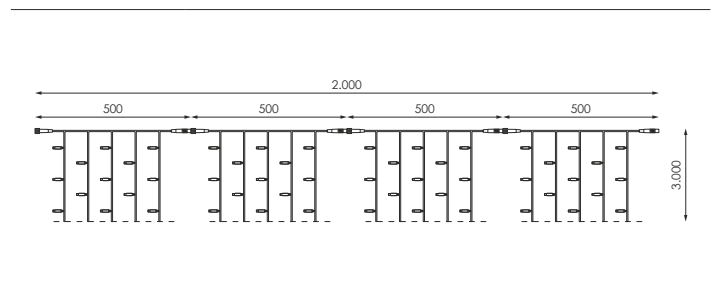

ESQUEMA INSTALACIÓN/  
INSTALLATION SCHEME/  
SCHEMA D'INSTALLATION/  
ESQUEMA DE  
INSTALAÇÃO



+

Producto/Product  
Produit/Produto

Accesorios (NO Incluidos) / Accessoires (NOT Included) / Accessories (NON Inclus) / Acessórios (NÃO Incluso)

+ INFO PAG. 366









995092  
Cable alimentación Negro

977722  
Cable alimentación Blanco



# SCREENLIGHT 600

Exterior

|  |              |
|--|--------------|
|  | 230V dc      |
| <b>Hz</b>  | 50-60Hz      |
|  | CII          |
|  | 1 CANAL      |
|  | IP65         |
|  | -20°C~+60 °C |
|  | 7kg (N.W.)   |
|  | NO INC.      |
|  | 10ud         |



SMART LINK 

Colegiata de Santa Julia,  
Santillana del Mar, Cantabria

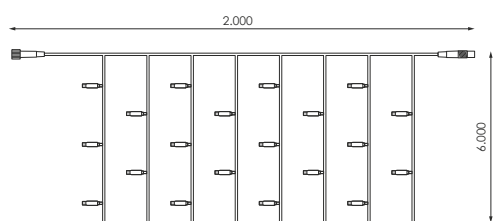

ESQUEMA INSTALACIÓN/  
INSTALLATION SCHEME/  
SCHEMA D'INSTALLATION/  
ESQUEMA DE  
INSTALAÇÃO



Producto/Product  
Produit/Produto



2x6m



20



600



30



35W



3sets



546898



2x6m



20



4



600



30



42,5W



3sets



530347



504133

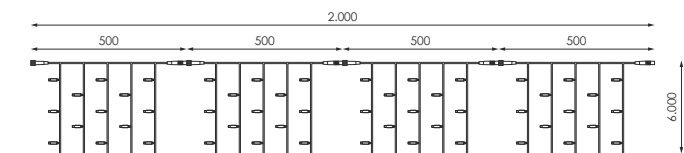

ESQUEMA INSTALACIÓN/  
INSTALLATION SCHEME/  
SCHEMA D'INSTALLATION/  
ESQUEMA DE  
INSTALAÇÃO



Producto/Product  
Produit/Produto

Accesorios (NO Incluidos) / Accessoires (NOT Included) / Accessories (NON Inclus) / Acessórios (NÃO Incluso)

+ INFO PAG. 366

995092

Cable alimentación Negro

977722

Cable alimentación Blanco



# SCREENLIGHT 900









Exterior















SMART LINK 



CC. Maltería Plaza  
Latacunga, Ecuador

|   |              |
|---|--------------|
|  | 230V dc      |
|  | 50-60Hz      |
|  | CII          |
|  | 1 CANAL      |
|  | IP65         |
|  | -20°C~+60 °C |
|  | 9kg (N.W.)   |
|  | NO INC.      |
|  | Tud          |

|   |   |   |
|---|---|---|
|  |  |  |
| 504027  |  |  |
| 504034  |  |  |

|   |               |
|---|---------------|
|  | 2x9m          |
|  | 20            |
|  | 4             |
|  | 900           |
|  | 45            |
| <b>W</b>  | 70W           |
|  | NO Empalmable |

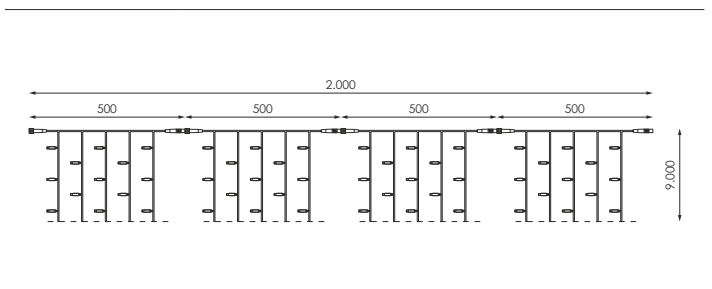

ESQUEMA INSTALACIÓN/  
INSTALLATION SCHEME/  
SCHEMA D'INSTALLATION/  
ESQUEMA DE  
INSTALAÇÃO



+

Producto/Product  
Produit/Produto

Accesorios (NO Incluidos) / Accessoires (NOT Included) / Accessories (NON Inclus) / Acessórios (NÃO Incluso)









+ INFO PAG. 366

995092  
Cable alimentación Negro

977722  
Cable alimentación Blanco

# SCREENLIGHT 150 Flashing

Exterior

|   |              |
|---|--------------|
|  | 230V dc      |
| <b>Hz</b>   | 50-60Hz      |
|  | CII          |
|  | 1 CANAL      |
|  | IP65         |
|  | -20°C~+60 °C |
|  | 1,5kg (N.W.) |
|  | NO INC.      |
|  | 10ud         |



SMART LINK 

Cortijo MBI  
Sevilla



[GRÁFICOS: Unidades en mm/ GRÁFICOS: Units in mm/ GRAPHICS: Units in mm/ GRÁFICOS: Unidades em mm]

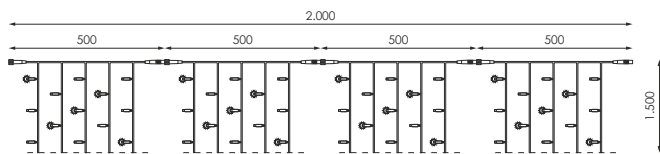













ESQUEMA INSTALACIÓN/  
INSTALLATION SCHEME/  
SCHEMA D'INSTALLATION/  
ESQUEMA DE  
INSTALAÇÃO



+

Producto/Product  
Produit/Produto

|   |                                     |
|---|-------------------------------------|
|  | 2x1,5m                              |
|  | 20                                  |
|  | 4                                   |
|  | 150                                 |
|  | 5+2<br>flashing<br>/6+2<br>flashing |
| <b>W</b>  | 15W                                 |
|  | 10sets                              |

|   |   |   |
|---|---|---|
|  |  |  |
| 504096  |  |  |
| 504102  |  |  |

Accesorios (NO Incluidos) / Accessoires (NOT Included) / Accessories (NON Inclus) / Acessórios (NÃO Incluso)

+ INFO PAG. 366

995092

Cable alimentación Negro

977722









Cable alimentación Blanco

# SCREENLIGHT 300 Flashing







Exterior









SMART LINK 

|   |              |
|---|--------------|
|  | 230V dc      |
|  | 50-60Hz      |
|  | CII          |
|  | 1 CANAL      |
|  | IP65         |
|  | -20°C~+60 °C |
|  | 3kg (N.W.)   |
|  | NO INC.      |
|  | 10ud         |

CC. Nervión Plaza  
Sevilla

|   |   |   |
|---|---|---|
|  |  |  |
| 504119  |  |  |
| 504126  |  |  |

|   |                  |
|---|------------------|
|  | 2x3m             |
|  | 20               |
|  | 4                |
|  | 300              |
|  | 12+3<br>flashing |
|  | 18,4W            |
|  | 7sets            |

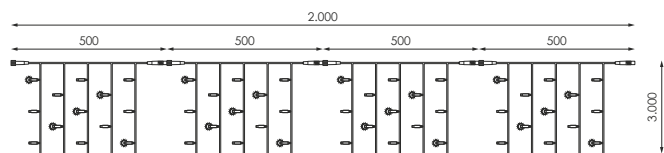

ESQUEMA INSTALACIÓN/  
INSTALLATION SCHEME/  
SCHEMA D'INSTALLATION/  
ESQUEMA DE  
INSTALAÇÃO



+

Producto/Product  
Produit/Produto

Accesorios (NO Incluidos) / Accessoires (NOT Included) / Accessories (NON Inclus) / Acessórios (NÃO Includo)

+ INFO PAG. 366

995092

Cable alimentación Negro









977722

Cable alimentación Blanco



# SCREENLIGHT 600 Flashing

Exterior

|   |              |
|---|--------------|
|  | 230V dc      |
| <b>Hz</b>   | 50-60Hz      |
|  | CII          |
|  | 1 CANAL      |
|  | IP65         |
|  | -20°C~+60 °C |
|  | 7kg (N.W.)   |
|  | NO INC.      |
|  | 10ud         |

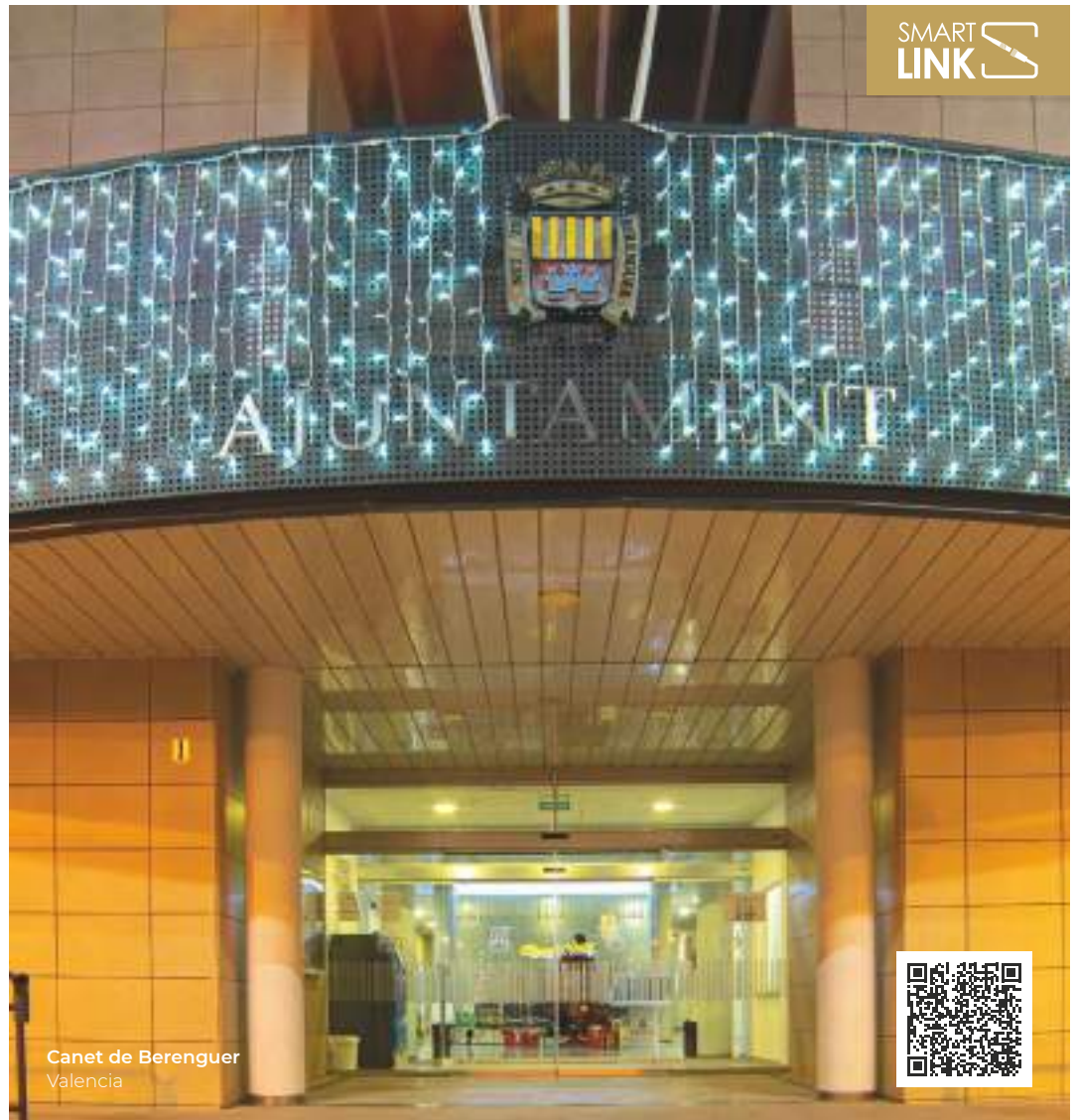

Canet de Berenguer  
Valencia



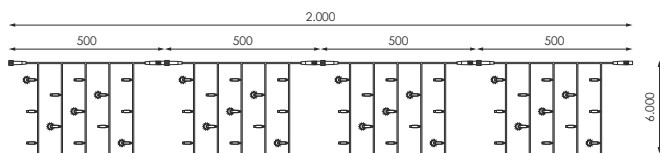









[GRÁFICOS: Unidades en mm/ GRÁFICOS: Units in mm/ GRAPHICS: Units in mm/ GRÁFICOS: Unidades em mm]



ESQUEMA INSTALACIÓN/  
INSTALLATION SCHEME/  
SCHEMA D'INSTALLATION/  
ESQUEMA DE  
INSTALAÇÃO



+ Producto/Product  
Produit/Produto

|   |                  |   |   |   |
|---|------------------|---|---|---|
|  | 2x6m             |  |  |  |
|  | 20               | 504140  |  |  |
|  | 4                | 504157  |  |  |
|  | 600              |   |   |   |
|  | 24+6<br>flashing |   |   |   |
| <b>W</b>  | 44W              |   |   |   |
|  | 3sets            |   |   |   |

Accesorios (NO Incluidos) / Accessoires (NOT Included) / Accessories (NON Inclus) / Acessórios (NÃO Incluso)

+ INFO PAG. 366

995092

Cable alimentación Negro

977722

Cable alimentación Blanco



# SCREENLIGHT 900 Flashing

Exterior



SMART LINK 

 230V dc

Hz 50-60Hz

 CII

 1 CANAL

 IP65

 -20°C~+60 °C













 9kg (N.W.)

 NO INC.

 Tud



CC. Quicentro  
Quito, Ecuador

|   |   |   |   |                  |
|---|---|---|---|------------------|
|  |  |  |  | 2x9m             |
| 504041  |  |  |  | 20               |
| 504058  |  |  |  | 4                |
|   |  |   |   | 900              |
|   |  |   |   | 36+9<br>flashing |
|   |   |   |   | W 70W            |
|   |  |   |   | NO<br>Empalmable |

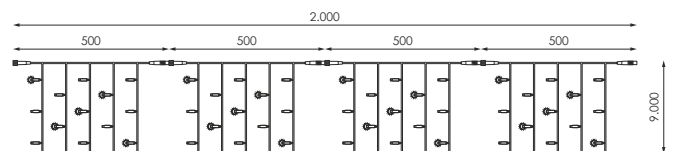

ESQUEMA INSTALACIÓN/  
INSTALLATION SCHEME/  
SCHEMA D'INSTALLATION/  
ESQUEMA DE  
INSTALAÇÃO



+

Producto/Product  
Produit/Produto

Accesorios (NO Incluidos) / Accessoires (NOT Included) / Accessories (NON Inclus) / Acessórios (NÃO Incluso)

+ INFO PAG. 366

995092

Cable alimentación Negro

977722

Cable alimentación Blanco



CC. Luz del Tajo  
Toledo



# ICICLE<sup>®</sup> 102

Exterior



SMART LINK

|  |              |
|--|--------------|
|  | 230V dc      |
|  | 50-60Hz      |
|  | CII          |
|  | 1 CANAL      |
|  | IP65         |
|  | -20°C~+60 °C |
|  | 1,4kg (N.W.) |
|  | NO INC.      |
|  | 10ud         |

Los Silos  
Santa Cruz de Tenerife

|        |  |  |
|--------|--|--|
|        |  |  |
| 546973 |  |  |
| 546980 |  |  |

|          |                       |
|----------|-----------------------|
|          | 3x1m<br>(1,5m x 2seg) |
|          | 2                     |
|          | 102                   |
|          | 51                    |
| <b>W</b> | 8W                    |
|          | 15sets                |

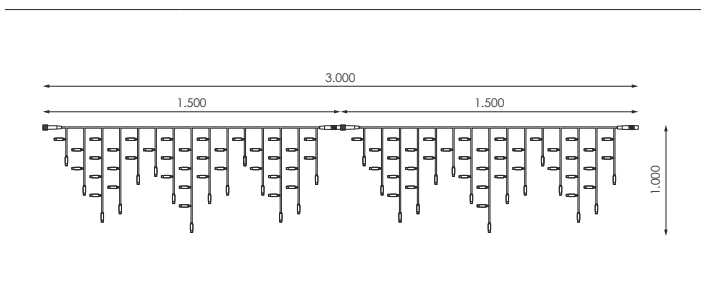

ESQUEMA INSTALACIÓN/  
INSTALLATION SCHEME/  
SCHEMA D'INSTALLATION/  
ESQUEMA DE  
INSTALACÃO

+ Producto/Product  
Produit/Produto

Accesorios (NO Incluidos) / Accessoires (NOT Included) / Accessories (NON Inclus) / Acessórios (NÃO Includo)









+ INFO PAG. 366

995092  
Cable alimentación Negro

977722  
Cable alimentación Blanco

# ICICLE<sup>®</sup> 102 Flashing

Exterior

|   |              |
|---|--------------|
|  | 230V dc      |
| <b>Hz</b>   | 50-60Hz      |
|  | CII          |
|  | 1 CANAL      |
|  | IP65         |
|  | -20°C~+60 °C |
|  | 1,4kg (N.W.) |
|  | NO INC.      |
|  | 10ud         |



Santa Cruz de Tenerife

[GRÁFICOS: Unidades en mm/ GRÁFICOS: Units in mm/ GRAPHICS: Units in mm/ GRÁFICOS: Unidades em mm]

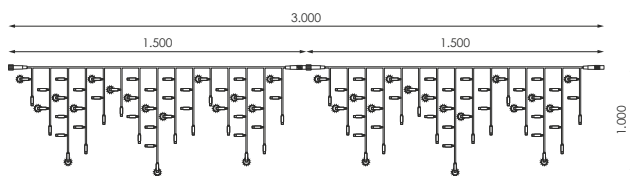













ESQUEMA INSTALACIÓN/  
INSTALLATION SCHEME/  
SCHEMA D'INSTALLATION/  
ESQUEMA DE  
INSTALAÇÃO



+

Producto/Product  
Produit/Produto

|   |                       |
|---|-----------------------|
|  | 3x1m<br>(1,5m x 2seg) |
|  | 2                     |
|  | 102                   |
|  | 42+9<br>flashing      |
| <b>W</b>  | 8W                    |
|  | 15sets                |

|   |   |   |
|---|---|---|
|  |  |  |
| 546997  |  |  |
| 547000  |  |  |

Accesorios (NO Incluidos) / Accessoires (NOT Included) / Accessories (NON Inclus) / Acessórios (NÃO Incluso)

+ INFO PAG. 366

995092

Cable alimentación Negro

977722

Cable alimentación Blanco



# STRING PLUS 100

Interior



SMART LINK

|           |              |
|-----------|--------------|
|           | 230V dc      |
| <b>Hz</b> | 50-60Hz      |
|           | CII          |
|           | 1 CANAL      |
|           | IP20         |
|           | -20°C~+60 °C |
|           | 0,9kg (N.W.) |
|           | NO INC.      |
|           | 10ud         |

CC. ABC Serrano  
Madrid

|        |  |  |
|--------|--|--|
|        |  |  |
| 547017 |  |  |
| 502030 |  |  |

|          |                    |
|----------|--------------------|
|          | 12m<br>(6m x 2seg) |
|          | 6m                 |
|          | 100                |
|          | 50                 |
| <b>W</b> | 8W                 |
|          | 4W                 |
|          | 100m               |

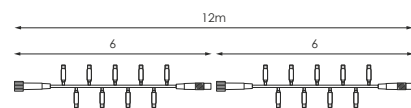

ESQUEMA INSTALACIÓN/  
INSTALLATION SCHEME/  
SCHEMA D'INSTALLATION/  
ESQUEMA DE  
INSTALAÇÃO



+

Producto/Product  
Produit/Produto

Accesorios (NO Incluidos) / Accessoires (NOT Included) / Accessories (NON Inclus) / Acessórios (NÃO Incluso)









+ INFO PAG. 366

192606

Cable alimentación Transparente

# SCREENLIGHT 100

Interior

|   |              |
|---|--------------|
|  | 230V dc      |
| <b>Hz</b>   | 50-60Hz      |
|  | CII          |
|  | 1 CANAL      |
|  | IP20         |
|  | -20°C~+60 °C |
|  | 1kg (N.W.)   |
|  | NO INC.      |
|  | 10ud         |



SMART LINK 

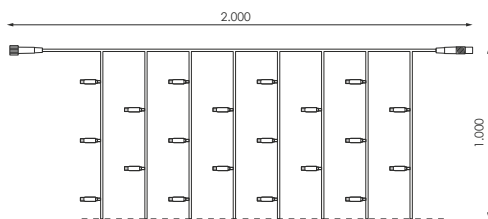

ESQUEMA INSTALACIÓN/  
INSTALLATION SCHEME/  
SCHEMA D'INSTALLATION/  
ESQUEMA DE  
INSTALAÇÃO



+ Producto/Product  
Produit/Produto



2x1m



20



100



5



7,5W



10sets



547031

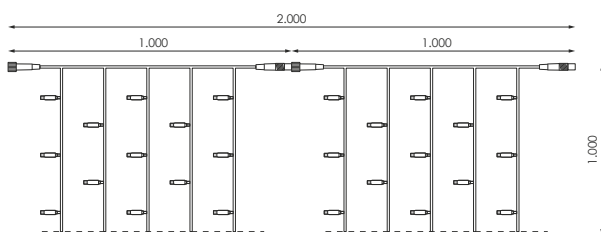

ESQUEMA INSTALACIÓN/  
INSTALLATION SCHEME/  
SCHEMA D'INSTALLATION/  
ESQUEMA DE  
INSTALAÇÃO



+ Producto/Product  
Produit/Produto



2x1m



20



2



100



5



8W



10sets



504072



Accesorios (NO Incluidos) / Accessoires (NOT Included) / Accessories (NON Inclus) / Acessórios (NÃO Incluso)

+ INFO PAG. 366

192606

Cable alimentación Transparente

# SCREENLIGHT 150

Interior



SMART LINK 

 230V dc

Hz 50-60Hz

 CII

 1 CANAL







 IP20





 -20°C~+60 °C

 1,5kg (N.W.)

 NO INC.

 10ud

|   |   |   |
|---|---|---|
|  |  |  |
| 547055  |  |  |
| 547062  |  |  |

|   |        |
|---|--------|
|  | 2x1,5m |
|  | 20     |
|  | 150    |
|  | 7/8    |
| W   | 12W    |
|  | 10sets |

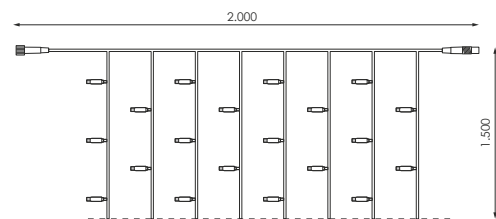









ESQUEMA INSTALACIÓN/  
INSTALLATION SCHEME/  
SCHEMA D'INSTALLATION/  
ESQUEMA DE  
INSTALAÇÃO



+

Producto/Product  
Produit/Produto

|   |   |   |
|---|---|---|
|  |  |  |
| 504089  |  |  |

|   |        |
|---|--------|
|  | 2x1,5m |
|  | 20     |
|  | 4      |
|  | 150    |
|  | 7/8    |
| W   | 15W    |
|  | 10sets |

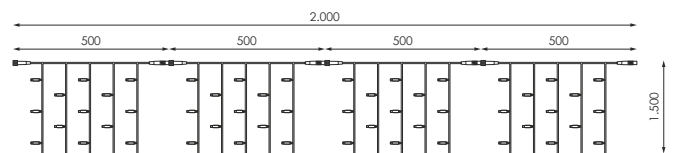

ESQUEMA INSTALACIÓN/  
INSTALLATION SCHEME/  
SCHEMA D'INSTALLATION/  
ESQUEMA DE  
INSTALAÇÃO



+

Producto/Product  
Produit/Produto

Accesorios (NO Incluidos) / Accessoires (NOT Included) / Accessories (NON Inclus) / Acessórios (NÃO Incluso)

+ INFO PAG. 366









192606

Cable alimentación Transparente



# SCREENLIGHT 300

Interior

|   |              |
|---|--------------|
|  | 230V dc      |
| <b>Hz</b>   | 50-60Hz      |
|  | CII          |
|  | 1 CANAL      |
|  | IP20         |
|  | -20°C~+60 °C |
|  | 3kg (N.W.)   |
|  | NO INC.      |
|  | 10ud         |



SMART LINK 



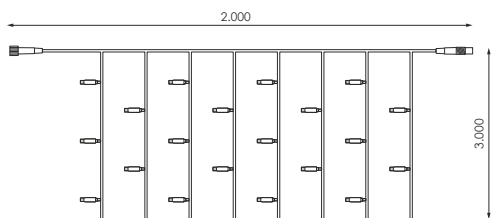

CC, Metromar  
Sevilla









ESQUEMA INSTALACIÓN/  
INSTALLATION SCHEME/  
SCHEMA D'INSTALLATION/  
ESQUEMA DE  
INSTALAÇÃO



+ Producto/Product  
Produit/Produto

|   |       |
|---|-------|
|  | 2x3m  |
|  | 20    |
|  | 300   |
|  | 15    |
| <b>W</b>  | 16W   |
|  | 7sets |

|   |   |   |
|---|---|---|
|  |  |  |
| 547079  |  |  |
| 547086  |  |  |

Accesorios (NO Incluidos) / Accessoires (NOT Included) / Accessories (NON Inklus) / Acessórios (NÃO Inklus)

+ INFO PAG. 366

192606

Cable alimentación Transparente











# SCREENLIGHT 600

Interior











SMART LINK 

|   |              |
|---|--------------|
|  | 230V dc      |
| Hz  | 50-60Hz      |
|  | CII          |
|  | 1 CANAL      |
|  | IP20         |
|  | -20°C~+60 °C |
|  | 7kg (N.W.)   |
|  | NO INC.      |
|  | 10ud         |



CC. Lagoh  
Sevilla

|   |   |   |
|---|---|---|
|  |  |  |
| 547093  |  |  |
| 547109  |  |  |

|   |       |
|---|-------|
|  | 2x6m  |
|  | 20    |
|  | 600   |
|  | 30    |
| W   | 35W   |
|  | 3sets |

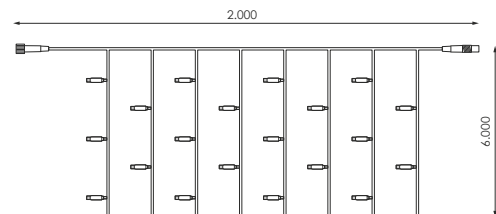

ESQUEMA INSTALACIÓN/  
INSTALLATION SCHEME/  
SCHEMA D'INSTALLATION/  
ESQUEMA DE  
INSTALAÇÃO



+

Producto/Product  
Produit/Produto

Accesorios (NO Incluidos) / Accessoires (NOT Included) / Accessories (NON Inclus) / Acessórios (NÃO Incluso)









+ INFO PAG. 366

192606

Cable alimentación Transparente

# SCREENLIGHT 150 Flashing

## Interior

|   |              |
|---|--------------|
|  | 230V dc      |
| <b>Hz</b>   | 50-60Hz      |
|  | CII          |
|  | 1 CANAL      |
|  | IP20         |
|  | -20°C~+60 °C |
|  | 1,5kg (N.W.) |
|  | NO INC.      |
|  | 10ud         |





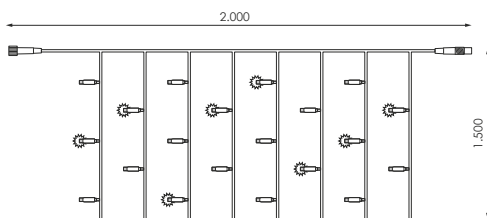

[GRÁFICOS: Unidades en mm/ GRAPHICS: Units in mm/ GRÁFICOS: Unidades em mm/ GRÁFICOS: Unidades em mm]











ESQUEMA INSTALACIÓN/  
INSTALLATION SCHEME/  
SCHEMA D'INSTALLATION/  
ESQUEMA DE  
INSTALAÇÃO



+ Producto/Product  
Produit/Produto

|   |                                     |
|---|-------------------------------------|
|  | 2x1,5m                              |
|  | 20                                  |
|  | 150                                 |
|  | 5+2<br>flashing<br>/6+2<br>flashing |
| <b>W</b>  | 12W                                 |
|  | 10sets                              |

|   |   |   |
|---|---|---|
|  |    |  |
| 547116  |   |  |
| 547123  |   |  |

Accesorios (NO Incluidos) / Accessoires (NOT Included) / Accessories (NON Inclus)/ Acessórios (NÃO Incluso)

+ INFO PAG. 366

192606









Cable alimentación Transparente

# SCREENLIGHT 300 Flashing







Interior









SMART LINK 

|   |              |
|---|--------------|
|  | 230V dc      |
|  | 50-60Hz      |
|  | CII          |
|  | 1 CANAL      |
|  | IP20         |
|  | -20°C~+60 °C |
|  | 3kg (N.W.)   |
|  | NO INC.      |
|  | 10ud         |

CC. Abadía  
Toledo

|   |   |   |
|---|---|---|
|  |  |  |
| 547130  |  |  |
| 547147  |  |  |

|   |                  |
|---|------------------|
|  | 2x3m             |
|  | 20               |
|  | 300              |
|  | 12+3<br>flashing |
|  | 17W              |
|  | 7sets            |

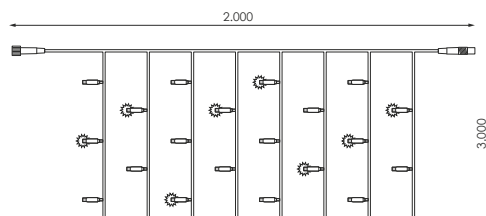

ESQUEMA INSTALACIÓN/  
INSTALLATION SCHEME/  
SCHEMA D'INSTALLATION/  
ESQUEMA DE  
INSTALAÇÃO



+

Producto/Product  
Produit/Produto

Accesorios (NO Incluidos) / Accessoires (NOT Included) / Accessories (NON Inclus) / Acessórios (NÃO Incluso)

+ INFO PAG. 366









192606

Cable alimentación Transparente



# SCREENLIGHT 600 Flashing

Interior

|   |              |
|---|--------------|
|  | 230V dc      |
| <b>Hz</b>   | 50-60Hz      |
|  | CII          |
|  | 1 CANAL      |
|  | IP20         |
|  | -20°C~+60 °C |
|  | 7kg (N.W.)   |
|  | NO INC.      |
|  | 10ud         |

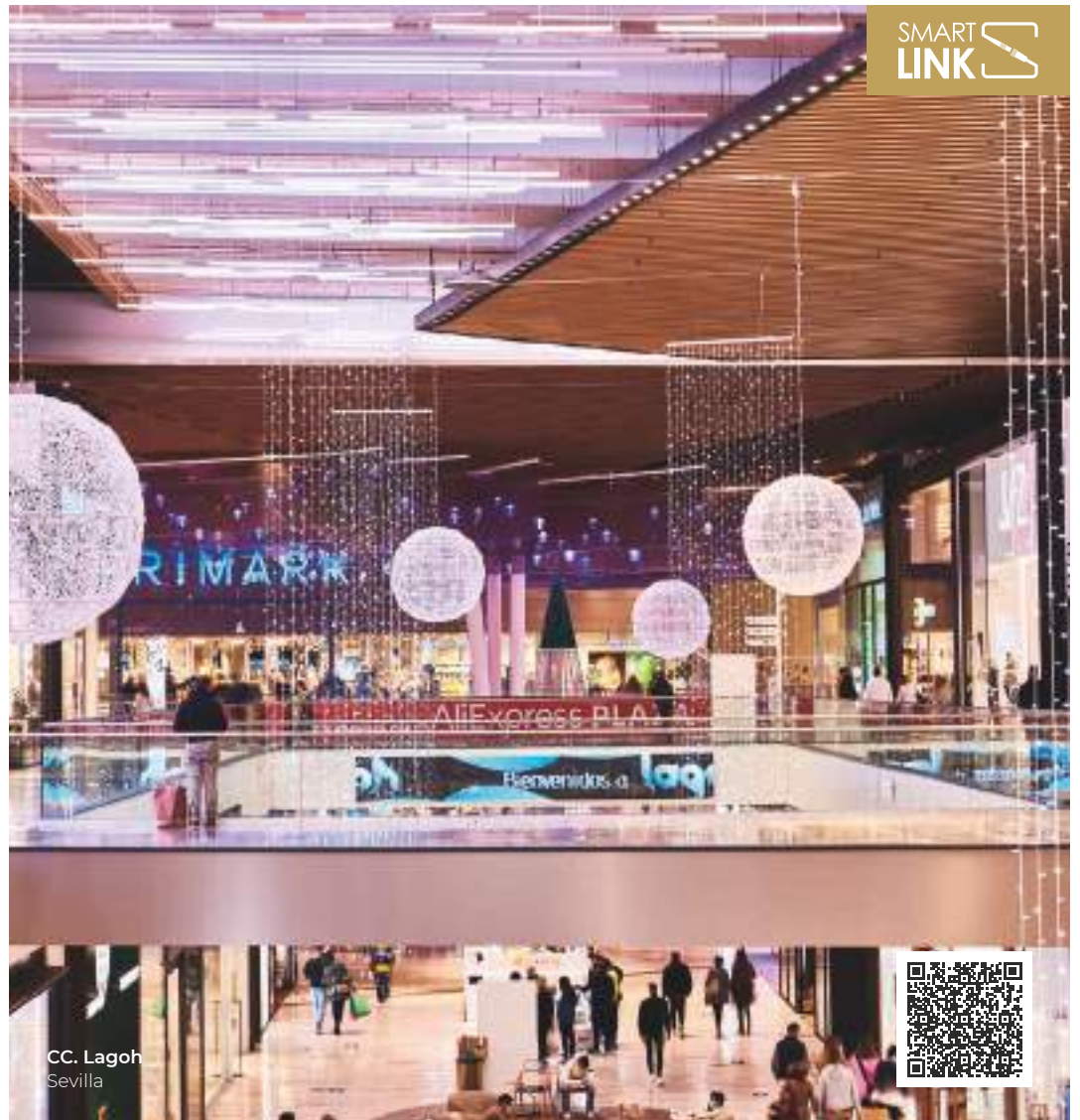

SMART LINK 



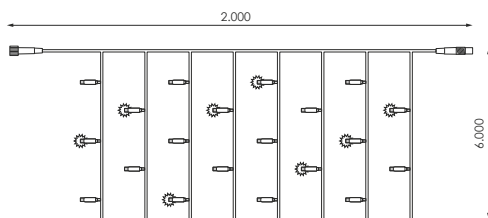









CC. Lagoh  
Sevilla



ESQUEMA INSTALACIÓN/  
INSTALLATION SCHEME/  
SCHEMA D'INSTALLATION/  
ESQUEMA DE  
INSTALAÇÃO



+ Producto/Product  
Produit/Produto

|   |                  |   |   |   |
|---|------------------|---|---|---|
|  | 2x6m             |  |  |  |
|  | 20               | 547154  |  |  |
|  | 600              | 547161  |  |  |
|  | 24+6<br>flashing |   |   |   |
| <b>W</b>  | 35W              |   |   |   |
|  | 3sets            |   |   |   |

Accesorios (NO Incluidos) / Accessoires (NOT Included) / Accessories (NON Inclus) / Acessórios (NÃO Incluso)

+ INFO PAG. 366

192606

Cable alimentación Transparente



# ICICLE<sup>®</sup> 102

Interior



|           |              |
|-----------|--------------|
|           | 230V dc      |
| <b>Hz</b> | 50-60Hz      |
|           | CII          |
|           | 1 CANAL      |
|           | IP20         |
|           | -20°C~+60 °C |
|           | 1,4kg (N.W.) |
|           | NO INC.      |
|           | 10ud         |

|        |  |  |
|--------|--|--|
|        |  |  |
| 547178 |  |  |
| 547185 |  |  |

|          |                       |
|----------|-----------------------|
|          | 3x1m<br>(1,5m x 2seg) |
|          | 2                     |
|          | 102                   |
|          | 51                    |
| <b>W</b> | 8W                    |
|          | 15sets                |

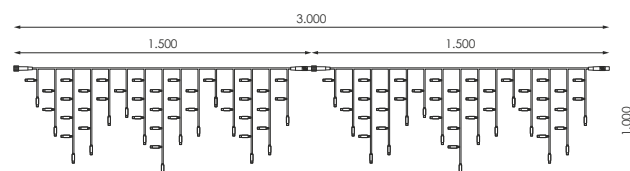

ESQUEMA INSTALACIÓN/  
INSTALLATION SCHEME/  
SCHEMA D'INSTALLATION/  
ESQUEMA DE  
INSTALAÇÃO



+

Producto/Product  
Produit/Produto

Accesorios (NO Incluidos) / Accessoires (NOT Included) / Accessories (NON Inclus) / Acessórios (NÃO Incluso)









+ INFO PAG. 366

192606

Cable alimentación Transparente

# ICICLE<sup>®</sup> 102 Flashing

Interior

|   |              |
|---|--------------|
|  | 230V dc      |
| <b>Hz</b>   | 50-60Hz      |
|  | CII          |
|  | 1 CANAL      |
|  | IP20         |
|  | -20°C~+60 °C |
|  | 1,4kg (N.W.) |
|  | NO INC.      |
|  | 10ud         |



SMART LINK 

[GRÁFICOS: Unidades en mm/ GRÁFICOS: Units in mm/ GRAPHICS: Units in mm/ GRÁFICOS: Unidades em mm]

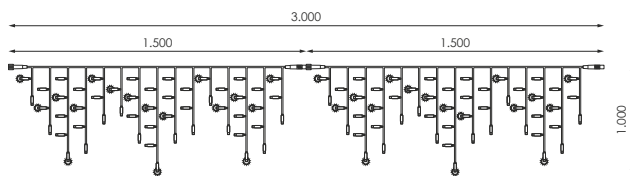













ESQUEMA INSTALACIÓN/  
INSTALLATION SCHEME/  
SCHEMA D'INSTALLATION/  
ESQUEMA DE  
INSTALAÇÃO



+

Producto/Product  
Produit/Produto

|   |                       |
|---|-----------------------|
|  | 3x1m<br>(1,5m x 2seg) |
|  | 2                     |
|  | 102                   |
|  | 42+9<br>flashing      |
| <b>W</b>  | 8W                    |
|  | 15sets                |

|   |   |   |
|---|---|---|
|  |  |  |
| 547192  |  |  |
| 547208  |  |  |

Accesorios (NO Incluidos) / Accessoires (NOT Included) / Accessories (NON Inclus)/ Acessórios (NÃO Incluso)

+ INFO PAG. 366

192606

Cable alimentación Transparente

# Accesorios (NO Incluidos)

Accessoires (NOT Included)

Accessories (NON Inclus)

Acessórios (NÃO Incluso)

|   |        | STRING PLUS<br>100<br>exterior | STRING PLUS<br>100 FLASHING<br>exterior | SCREENLIGHT<br>exterior | SCREENLIGHT<br>FLASHING<br>exterior | ICICLE#<br>102<br>exterior | ICICLE#<br>102 FLASHING<br>exterior | STRING PLUS<br>100<br>interior | SCREENLIGHT<br>interior | SCREENLIGHT<br>FLASHING<br>interior | ICICLE#<br>102<br>interior | ICICLE#<br>102 FLASHING<br>interior |
|---|--------|--------------------------------|---|-------------------------|-------------------------------------|----------------------------|-------------------------------------|--------------------------------|-------------------------|-------------------------------------|----------------------------|-------------------------------------|
| ⏏ | 192606 |                                |   |                         |                                     |                            |                                     | •                              | •                       | •                                   | •                          | •                                   |
|   | 977722 | •                              | •                                       | •                       | •                                   | •                          | •                                   |                                |                         |                                     |                            |                                     |
|   | 995092 | •                              | •                                       | •                       | •                                   | •                          | •                                   |                                |                         |                                     |                            |                                     |
| ⏏ | 192323 | •                              | •                                       | •                       | •                                   | •                          | •                                   |                                |                         |                                     |                            |                                     |
|   | 192347 | •                              | •                                       | •                       | •                                   | •                          | •                                   |                                |                         |                                     |                            |                                     |
|   | 192354 | •                              | •                                       | •                       | •                                   | •                          | •                                   |                                |                         |                                     |                            |                                     |
|   | 192361 | •                              | •                                       | •                       | •                                   | •                          | •                                   |                                |                         |                                     |                            |                                     |
|   | 192378 | •                              | •                                       | •                       | •                                   | •                          | •                                   |                                |                         |                                     |                            |                                     |
|   | 192385 | •                              | •                                       | •                       | •                                   | •                          | •                                   |                                |                         |                                     |                            |                                     |
|   | 192392 | •                              | •                                       | •                       | •                                   | •                          | •                                   |                                |                         |                                     |                            |                                     |
|   | 192408 | •                              | •                                       | •                       | •                                   | •                          | •                                   |                                |                         |                                     |                            |                                     |
|   | 192415 | •                              | •                                       | •                       | •                                   | •                          | •                                   |                                |                         |                                     |                            |                                     |
|   | 192422 | •                              | •                                       | •                       | •                                   | •                          | •                                   |                                |                         |                                     |                            |                                     |
|   | 192439 | •                              | •                                       | •                       | •                                   | •                          | •                                   |                                |                         |                                     |                            |                                     |
|   | 192446 | •                              | •                                       | •                       | •                                   | •                          | •                                   |                                |                         |                                     |                            |                                     |
|   | 388368 | •                              | •                                       | •                       | •                                   | •                          | •                                   |                                |                         |                                     |                            |                                     |
|   | 388375 | •                              | •                                       | •                       | •                                   | •                          | •                                   |                                |                         |                                     |                            |                                     |
|   | 388382 | •                              | •                                       | •                       | •                                   | •                          | •                                   |                                |                         |                                     |                            |                                     |
|   | 388399 | •                              | •                                       | •                       | •                                   | •                          | •                                   |                                |                         |                                     |                            |                                     |
|   | 388498 | •                              | •                                       | •                       | •                                   | •                          | •                                   |                                |                         |                                     |                            |                                     |
|   | 388504 | •                              | •                                       | •                       | •                                   | •                          | •                                   |                                |                         |                                     |                            |                                     |
|   | 391498 | •                              | •                                       | •                       | •                                   | •                          | •                                   |                                |                         |                                     |                            |                                     |
|   | 391504 | •                              | •                                       | •                       | •                                   | •                          | •                                   |                                |                         |                                     |                            |                                     |

CABLE ALIMENTACIÓN SMART LINK exterior

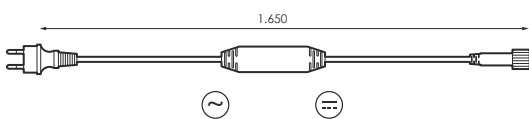

CABLE ALIMENTACIÓN SMART LINK interior

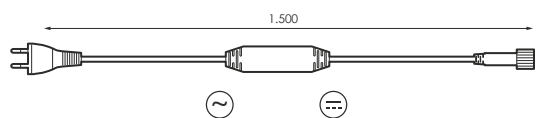

|        | ⏏ | ⦿ | ⚡      | W         | □   | ⦿                          |
|--------|---|---|--------|-----------|-----|----------------------------|
| 995092 | ⦿ | ⦿ | 230Vac | Max. 480W | CII | IP44 Plug<br>IP65 Conector |
| 977722 | ⦿ | ⦿ | 230Vac | Max. 480W | CII | IP44 Plug<br>IP65 Conector |

|        | ⏏ | ⦿ | ⚡      | W         | □   | ⦿    |
|--------|---|---|--------|-----------|-----|------|
| 192606 | ⦿ | ⦿ | 230Vac | Max. 480W | CII | IP20 |

### CONECTOR T SMART LINK

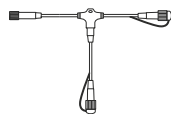

|        |  |      |
|--------|--|------|
|        |  |      |
| 192446 |  | IP65 |
| 192439 |  | IP65 |

### CONECTOR X SMART LINK

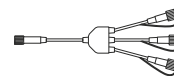

|        |  |      |
|--------|--|------|
|        |  |      |
| 391504 |  | IP65 |
| 391498 |  | IP65 |

### CONECTOR 5 SMART LINK

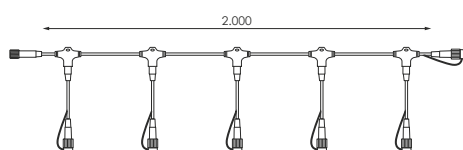

|        |    |   |  |      |
|--------|----|---|--|------|
|        |    |   |  |      |
| 388375 | 2m | 5 |  | IP65 |
| 388368 | 2m | 5 |  | IP65 |

### CONECTOR 10 SMART LINK

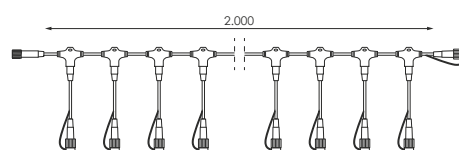

|        |    |    |  |      |
|--------|----|----|--|------|
|        |    |    |  |      |
| 388399 | 2m | 10 |  | IP65 |
| 388382 | 2m | 10 |  | IP65 |

### CONECTOR 10 SMART LINK

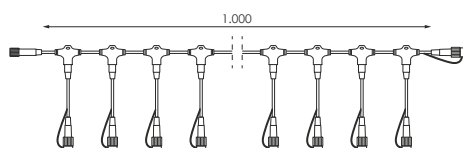

|        |    |    |  |      |
|--------|----|----|--|------|
|        |    |    |  |      |
| 192408 | 1m | 10 |  | IP65 |
| 192392 | 1m | 10 |  | IP65 |

### CONECTOR 20 SMART LINK

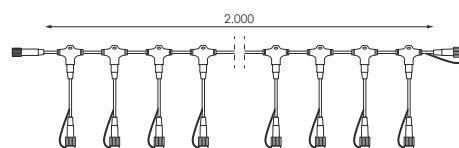

|        |    |    |  |      |
|--------|----|----|--|------|
|        |    |    |  |      |
| 192422 | 2m | 20 |  | IP65 |
| 192415 | 2m | 20 |  | IP65 |

### EXTENSIÓN SMART LINK

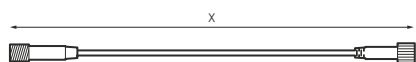

|        |      |  |      |
|--------|------|--|------|
|        |      |  |      |
| 388498 | 0,5m |  | IP65 |
| 388504 | 0,5m |  | IP65 |
| 192347 | 1m   |  | IP65 |
| 192323 | 1m   |  | IP65 |
| 192361 | 3m   |  | IP65 |
| 192354 | 3m   |  | IP65 |
| 192385 | 5m   |  | IP65 |
| 192378 | 5m   |  | IP65 |







# Led Exterior

Outdoors Led  
Led à l'exterieur  
Led ao ar livre

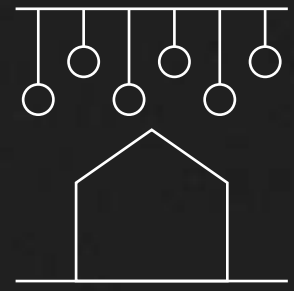

# String AVANT 180

IP67



Villanueva de Gallego  
Zaragoza

SMART LINK  
AVANT

⚡ 230V dc

Hz 50-60Hz

□ CII

☺ 1 CANAL

⊙ IP67

🌡 -20°C~+60 °C

📊 1,14kg (N.W.)

⊗ NO INC.

📦 10ud



|        |  |  |
|--------|--|--|
|        |  |  |
| 486941 |  |  |
| 486958 |  |  |
| 486965 |  |  |
| 486972 |  |  |
| 486989 |  |  |
| 486996 |  |  |
| 487009 |  |  |
| 487016 |  |  |
| 487023 |  |  |
| 487030 |  |  |

|   |                    |
|---|--------------------|
| ↔ | 12m<br>(4m x 3seg) |
| ⏏ | 4m                 |
| 💡 | 180                |
| 💡 | 60                 |
| W | 10W                |
| ⏏ | 3W                 |
| ⚙ | 100m               |

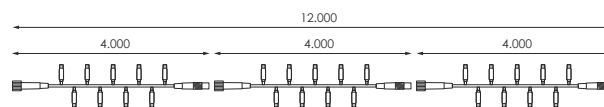

ESQUEMA INSTALACIÓN/  
INSTALLATION SCHEME/  
SCHÉMA D'INSTALLATION/  
ESQUEMA DE  
INSTALAÇÃO



+

Producto/Product  
Produit/Produto

Accesorios (NO Incluidos) / Accessoires (NOT Included) / Accessories (NON Inclus) / Acessórios (NÃO Incluso)

+ INFO PAG. 418

487207

Cable alimentación Negro

487214

Cable alimentación Blanco



# String AVANT 180

IP67 Flashing

|           |               |
|-----------|---------------|
|           | 230V dc       |
| <b>Hz</b> | 50-60Hz       |
|           | CII           |
|           | 1 CANAL       |
|           | IP67          |
|           | -20°C~+60 °C  |
|           | 1,14kg (N.W.) |
|           | NO INC.       |
|           | 10ud          |



SMART LINK  
AVANT

Arucas  
Canarias

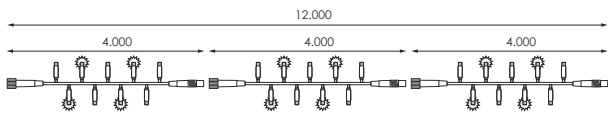

ESQUEMA INSTALACIÓN/  
INSTALLATION SCHEME/  
SCHEMA D'INSTALLATION/  
ESQUEMA DE  
INSTALAÇÃO



Producto/Product  
Produit/Produto

|          |                    |
|----------|--------------------|
|          | 12m<br>(4m x 3seg) |
|          | 4m                 |
|          | 180                |
|          | 50+10<br>flashing  |
| <b>W</b> | 10W                |
|          | 3W                 |
|          | 100m               |

|        |  |  |
|--------|--|--|
|        |  |  |
| 486873 |  |  |
| 486880 |  |  |
| 486859 |  |  |
| 486866 |  |  |
| 486897 |  |  |
| 486903 |  |  |
| 486910 |  |  |
| 486927 |  |  |

Accesorios (NO Incluidos) / Accessoires (NOT Included) / Accessories (NON Inclus) / Acessórios (NÃO Incluso)

+ INFO PAG. 418

487207

Cable alimentación Negro

487214

Cable alimentación Blanco



# STRING **PLUS** 180

## 24V Fuente Alimentación



|  |              |
|--|--------------|
|  | 24V dc       |
|  | 50-60Hz      |
|  | CIII         |
|  | 1 CANAL      |
|  | IP65         |
|  | -20°C~+60 °C |
|  | 0,9kg (N.W.) |
|  | NO INC.      |
|  | 10ud         |

|        |  |  | W    |
|--------|--|--|------|
| 149174 |  |  | 8W   |
| 146449 |  |  | 8,5W |
| 505567 |  |  | 7W   |
| 505574 |  |  | 5,8W |
| 191982 |  |  | 5,8W |
| 441865 |  |  | 6,5W |
| 477925 |  |  | 8,5W |
| 441896 |  |  | 8,5W |
| 441872 |  |  | 8,5W |
| 441889 |  |  | 8,5W |

|  |                    |
|--|--------------------|
|  | 12m<br>(4m x 3seg) |
|  | 4m                 |
|  | 180                |
|  | 60                 |
|  | *Accesorios        |

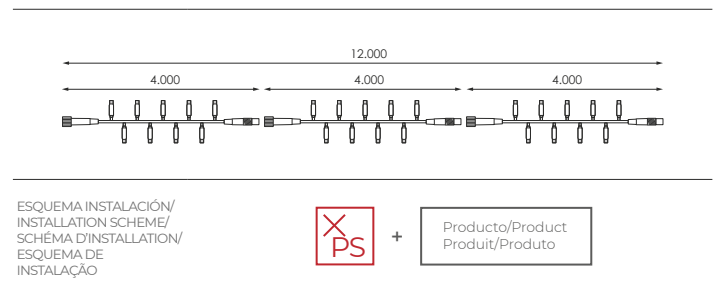

### Aviso/Warning/Avertissement/Aviso

Ñ/ Uso **OBLIGATORIO** de fuente de alimentación.

E/ You **MUST USE** the power supply.

F/ L'utilisation **OBLIGATOIRE** du l'alimentation

P/ Uso **OBRIGATÓRIO** fonte de alimentação.

### Accesorios (NO Incluidos) / Accessoires (NOT Included) / Accessories (NON Inclus)/ Acessórios (NÃO Incluso)

+ INFO PAG. 418

Ñ/ Fuente de alimentación **NO INCLUIDA**

E/ Power supply **NOT INCLUDED**

F/ Alimentation **NON INCLUSE**

P/ Fonte de alimentação **NÃO INCLUIDO**

|        |                              |
|--------|------------------------------|
| 488440 | Fuente alimentación 30W 24V  |
| 488464 | Fuente alimentación 100W 24V |
| 571968 | Fuente alimentación 200W 24V |

|        |                              |
|--------|------------------------------|
| 488457 | Fuente alimentación 60W 24V  |
| 481687 | Fuente alimentación 150W 24V |

| 488440 | 48m                           |
|--------|-------------------------------|
| 488457 | 100m paralelo<br>48m en serie |
| 488464 | 168m paralelo<br>48m en serie |
| 481687 | 252m paralelo<br>48m en serie |
| 571968 | 340m paralelo<br>48m en serie |

# STRING **PLUS** 180

## 24V Flashing Fuente Alimentación

|           |              |
|-----------|--------------|
|           | 24V dc       |
| <b>Hz</b> | 50-60Hz      |
|           | CIII         |
|           | 1 CANAL      |
|           | IP65         |
|           | -20°C~+60 °C |
|           | 0,9kg (N.W.) |
|           | NO INC.      |
|           | 10ud         |



Arcos Valdevez  
Portugal

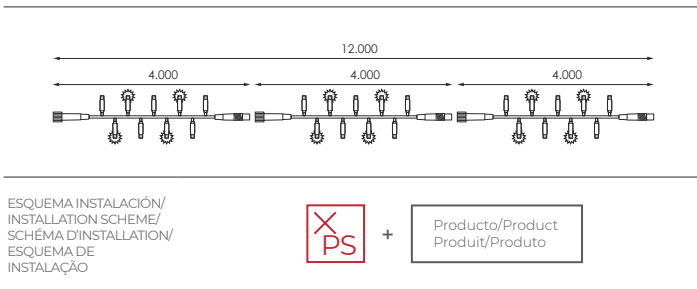

|  |                    |
|--|--------------------|
|  | 12m<br>(4m x 3seg) |
|  | 4m                 |
|  | 180                |
|  | 50+10<br>flashing  |
|  | *Accesorios        |

| 413732 |  |  | 8,5W |
|--------|--|--|------|
| 413749 |  |  | 8,4W |
| 505598 |  |  | 7,8W |
| 505604 |  |  | 8,5W |
| 561488 |  |  | 7,4W |
| 561495 |  |  | 8,5W |
| 561501 |  |  | 7,4W |
| 598408 |  |  | 8,5W |
| 542296 |  |  | 8,5W |
| 505628 |  |  | 7,8W |
| 505611 |  |  | 8,5W |

### Aviso/Warning/Avertissement/Aviso

**Ñ/** Uso **OBLIGATORIO** de fuente de alimentación.

**E/** You **MUST USE** the power supply.

**F/** L'utilisation **OBLIGATOIRE** du l'alimentation

**P/** Uso **OBRIGATÓRIO** fonte de alimentação.

### Accesorios (NO Incluidos) / Accessoires (NOT Included) / Accessories (NON Inclus)/ Acessórios (NÃO Incluso) + INFO PAG. 418

**Ñ/** Fuente de alimentación **NO INCLUIDA**

**E/** Power supply **NOT INCLUDED**

**F/** Alimentation **NON INCLUSE**

**P/** Fonte de alimentação **NÃO INCLUIDO**

|        |                              |
|--------|------------------------------|
| 488440 | Fuente alimentación 30W 24V  |
| 488464 | Fuente alimentación 100W 24V |
| 571968 | Fuente alimentación 200W 24V |

|        |                              |
|--------|------------------------------|
| 488457 | Fuente alimentación 60W 24V  |
| 481687 | Fuente alimentación 150W 24V |

| 488440 | 48m                           |
|--------|-------------------------------|
| 488457 | 100m paralelo<br>48m en serie |
| 488464 | 168m paralelo<br>48m en serie |
| 481687 | 252m paralelo<br>48m en serie |
| 571968 | 340m paralelo<br>48m en serie |

# STRING PLUS 180

## 24V Transformador



CC. El Saler  
Valencia

|  |              |
|--|--------------|
|  | 24V dc       |
|  | 50-60Hz      |
|  | CIII         |
|  | IP65         |
|  | -20°C~+60 °C |
|  | 0,9kg (N.W.) |
|  | NO INC.      |
|  | NO INC.      |
|  | 10ud         |

|        |  |  |
|--------|--|--|
|        |  |  |
| 191968 |  |  |
| 191975 |  |  |
| 191999 |  |  |
| 542258 |  |  |
| 542265 |  |  |
| 542289 |  |  |
| 542234 |  |  |
| 542326 |  |  |

|  |                    |
|--|--------------------|
|  | 12m<br>(4m x 3seg) |
|  | 4m                 |
|  | 180                |
|  | 60                 |
|  | 50+10<br>flashing  |
|  | 9W                 |
|  | 3W                 |
|  | *Accesorios        |

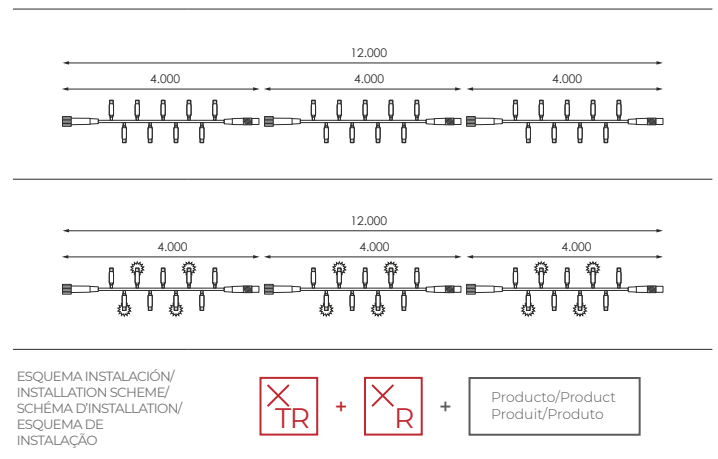

### Aviso/Warning/Avertissement/Aviso

**Ñ/** Uso **OBLIGATORIO** de transformador y rectificador. El transformador de 10,8W (149181), de 28,8W (149198) y de 60W (149204) se utilizarán con el rectificador máx. 60W (150323). El transformador de 120W (149211) se utilizará con el rectificador máx. 96W (364478).

**E/** You **MUST USE** the transformer and rectifier. The 10.8W, 28.8W and 60W transformers (149181/149198/149204) will be used with the rectifier 60W maximum (150323). The 120W transformer (149211) will be used with the rectifier 96W maximum (364478).

**F/** L'utilisation **OBLIGATOIRE** du transformateur et redresseur. Les transformateurs de 10.8W, 28.8W et 60W (149181/149198/149204) seront utilisés avec redresseur 60W au maximum (150323). Le transformateur de 120W (149211) est utilisée avec le redresseur 96W maximale (364478).

**P/** Uso **OBRIGATÓRIO** de transformador e retificador. Os transformadores de 10.8W, 28.8W e 60W (149181/149198/149204) serão usados com o retificador 60W máximo (150323). O transformador de 120W (149211) será usado com o retificador máximo 96W (364478).

### Accesorios (NO Incluidos) / Accessoires (NOT Included) / Accessories (NON Inclus)/ Acessórios (NÃO Incluso)

+ INFO PAG. 418

**Ñ/** Transformador y rectificador **NO INCLUIDO**

**E/** Transformer and rectifier **NOT INCLUDED**

**F/** Transformateur et redresseur **NON INCLUS**

**P/** Transformador e retificador **NÃO INCLUIDO**

|        |                       |        |                       |
|--------|-----------------------|--------|-----------------------|
| 149181 | Transformador 10,8W   | 149198 | Transformador 28,8W   |
| 149204 | Transformador 60W     | 149211 | Transformador 120W    |
| 150323 | Rectificador máx. 60W | 364478 | Rectificador máx. 96W |

|        |                               |
|--------|-------------------------------|
|        |                               |
| 149181 | 12m                           |
| 149198 | 36m                           |
| 149204 | 80m paralelo<br>48m en serie  |
| 149211 | 160m paralelo<br>48m en serie |

# STRING **PLUS** 180

## 1 Sección

|           |              |
|-----------|--------------|
|           | 230V dc      |
| <b>Hz</b> | 50-60Hz      |
|           | CII          |
|           | 1 CANAL      |
|           | IP65         |
|           | -20°C~+60 °C |
|           | 0,9kg (N.W.) |
|           | NO INC.      |
|           | 10ud         |

**Ñ/ \*120LEDs / 12m / 2 Segmentos de 6m / Con cable de alimentación. E/ \*120LEDs / 12m / 2 Segments of 6m / With power cable. F/ \*120LEDs / 12m / 2 Segments de 6m / Avec câble d'alimentation. P/ \*120LEDs / 12m / 2 Segmentos de 6m / Com cabo de alimentação**



Maliaño  
Camargo, Santander

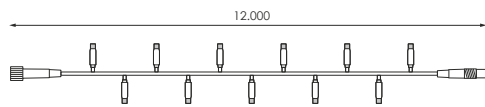

ESQUEMA INSTALACIÓN/  
INSTALLATION SCHEME/  
SCHEMA D'INSTALLATION/  
ESQUEMA DE  
INSTALAÇÃO



+ Producto/Product  
Produit/Produto

|          |      |
|----------|------|
|          | 12m  |
|          | 12m  |
|          | 180  |
| <b>W</b> | 11W  |
|          | 100m |

|         |  |  |
|---------|--|--|
|         |  |  |
| 960847  |  |  |
| 163521  |  |  |
| 388146  |  |  |
| 477994  |  |  |
| 478021  |  |  |
| 388115  |  |  |
| 388122  |  |  |
| 476010  |  |  |
| 478014  |  |  |
| 478007  |  |  |
| 530293  |  |  |
| 087773* |  |  |

Accesorios (NO Incluidos) / Accessoires (NOT Included) / Accessories (NON Inclus) / Acessórios (NÃO Incluso)

+ INFO PAG. 418

995092

Cable alimentación Negro

977722

Cable alimentación Blanco



# STRING **PLUS** 180

## Cápsula Clara



SMART  
LINK



CC Nervión Plaza  
Sevilla

⚡ 230V dc

Hz 50-60Hz

☐ CII

🎚️ 1 CANAL

🌡️ IP65

🌡️ -20°C~+60 °C

📊 1,14kg (N.W.)

⊗ NO INC.

📦 10ud

| Barcode | LED | Light Type | Control |
|---------|-----|------------|---------|
| 995108  | LED | White      | Control |
| 163651  | LED | White      | Control |
| 995115  | LED | White      | Control |
| 995122  | LED | White      | Control |
| 546577  | LED | White      | Control |
| 546584  | LED | White      | Control |
| 163477  | LED | White      | Control |
| 477987  | LED | White      | Control |
| 477949  | LED | White      | Control |
| 163507  | LED | White      | Control |
| 163491  | LED | White      | Control |
| 542227  | LED | White      | Control |
| 588614  | LED | White      | Control |
| 163514  | LED | White      | Control |
| 477932  | LED | White      | Control |
| 388153  | LED | White      | Control |
| 388160  | LED | White      | Control |

|     |                    |
|-----|--------------------|
| ↔   | 12m<br>(4m x 3seg) |
| ┆┆┆ | 4m                 |
| 💡   | 180                |
| 💡   | 60                 |
| W   | 10W                |
| ┆┆┆ | 3W                 |
| 🔗   | 100m               |

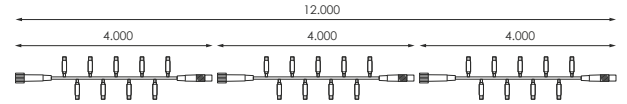

ESQUEMA INSTALACIÓN/  
INSTALLATION SCHEME/  
SCHÉMA D'INSTALLATION/  
ESQUEMA DE  
INSTALAÇÃO



+ Producto/Product  
Produit/Produto

Accesorios (NO Incluidos) / Accessoires (NOT Included) / Accessories (NON Inclus) / Acessórios (NÃO Incluso)

+ INFO PAG. 418

995092

Cable alimentación Negro

977722

Cable alimentación Blanco

# STRING **PLUS** 180

## Cápsula Mate

|  |               |
|--|---------------|
|  | 230V dc       |
|  | 50-60Hz       |
|  | CII           |
|  | 1 CANAL       |
|  | IP65          |
|  | -20°C~+60 °C  |
|  | 1,14kg (N.W.) |
|  | NO INC.       |
|  | 10ud          |



Arucas  
Canarias

SMART  
LINK

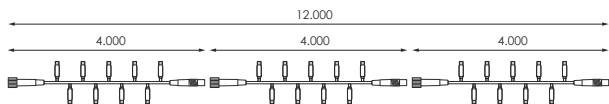

ESQUEMA INSTALACIÓN/  
INSTALLATION SCHEME/  
SCHEMA D'INSTALLATION/  
ESQUEMA DE  
INSTALAÇÃO



Producto/Product  
Produit/Produto

|          |                    |
|----------|--------------------|
|          | 12m<br>(4m x 3seg) |
|          | 4m                 |
|          | 180                |
|          | 60                 |
| <b>W</b> | 10W                |
|          | 3W                 |
|          | 100m               |

| 148894 |  |  |  |
|--------|--|--|--|
| 146227 |  |  |  |
| 961165 |  |  |  |
| 952361 |  |  |  |
| 095587 |  |  |  |
| 966450 |  |  |  |
| 952392 |  |  |  |
| 405829 |  |  |  |
| 952378 |  |  |  |
| 191951 |  |  |  |
| 952385 |  |  |  |
| 405843 |  |  |  |
| 952408 |  |  |  |
| 977241 |  |  |  |

Accesorios (NO Incluidos) / Accessoires (NOT Included) / Accessories (NON Inclus) / Acessórios (NÃO Incluso)

+ INFO PAG. 418

995092

Cable alimentación Negro

977722

Cable alimentación Blanco

# STRING **PLUS** 120

## All Flashing



SMART  
LINK 

 230V dc

**Hz** 50-60Hz

 CII

 1 CANAL

 IP65

 -20°C~+60 °C







 0,9kg (N.W.)







 NO INC.

 10ud



CC. Luz del Tajo  
Toledo

|   |   |   |
|---|---|---|
|  |  |  |
| 977715  |  |  |
| 995160  |  |  |

|   |                    |
|---|--------------------|
|  | 12m<br>(4m x 3seg) |
|  | 4m                 |
|  | 120<br>flashing    |
|  | 40<br>flashing     |
| <b>W</b>  | 10,5W              |
|  | 3,5W               |
|  | 100m               |

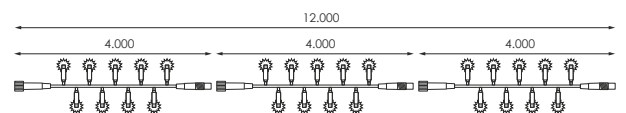

ESQUEMA INSTALACIÓN/  
INSTALLATION SCHEME/  
SCHEMA D'INSTALLATION/  
ESQUEMA DE  
INSTALAÇÃO



+

Producto/Product  
Produit/Produto

Accesorios (NO Incluidos) / Accessoires (NOT Included) / Accessories (NON Inclus) / Acessórios (NÃO Incluso)

+ INFO PAG. 418

995092

Cable alimentación Negro

977722

Cable alimentación Blanco



# STRING **PLUS** 180

## Sparkle Cápsula Clara

|           |              |
|-----------|--------------|
|           | 230V dc      |
| <b>Hz</b> | 50-60Hz      |
|           | CII          |
|           | 1 CANAL      |
|           | IP65         |
|           | -20°C~+60 °C |
|           | 0,9kg (N.W.) |
|           | NO INC.      |
|           | 10ud         |



[GRÁFICOS: Unidades en mm/ GRAPPHICS: Units in mm/GRÁFICOS: Unidades en mm/GRÁFICOS: Unidades en mm]

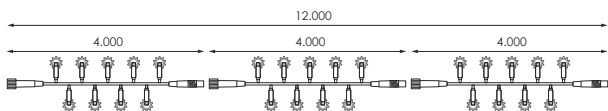

ESQUEMA INSTALACIÓN/  
INSTALLATION SCHEME/  
SCHÉMA D'INSTALLATION/  
ESQUEMA DE  
INSTALAÇÃO



Producto/Product  
Produit/Produto

|          |                    |
|----------|--------------------|
|          | 12m<br>(4m x 3seg) |
|          | 4m                 |
|          | 180<br>sparkle     |
|          | 60<br>sparkle      |
| <b>W</b> | 9,5W               |
|          | 3,2W               |
|          | 100m               |

| 512480* |  |  |  |
|---------|--|--|--|
| 512442  |  |  |  |
| 512459  |  |  |  |
| 512466  |  |  |  |
| 512473  |  |  |  |
| 512497  |  |  |  |
| 512503  |  |  |  |
| 512510  |  |  |  |
| 512527  |  |  |  |
| 512541  |  |  |  |
| 512893  |  |  |  |

### Información/Information/Information/Informações

**Ñ/ \*** Multicolor.

**E/ \*** Multicolored.

**F/ \*** Multicolore.

**P/ \*** Multicolorido.

Accesorios (NO Incluidos) / Accessoires (NOT Included) / Accessories (NON Inclus) / Acessórios (NÃO Incluso)

+ INFO PAG. 418

995092

Cable alimentación Negro

977722

Cable alimentación Blanco



# STRING **PLUS** 180

## Flashing Cápsula Clara



|           |               |
|-----------|---------------|
|           | 230V dc       |
| <b>Hz</b> | 50-60Hz       |
|           | CII           |
|           | 1 CANAL       |
|           | IP65          |
|           | -20°C~+60 °C  |
|           | 1,15kg (N.W.) |
|           | NO INC.       |
|           | 10ud          |

| 542357 |  |  |
|--------|--|--|
| 542364 |  |  |
| 995146 |  |  |
| 977647 |  |  |
| 542388 |  |  |
| 542395 |  |  |
| 542371 |  |  |
| 542401 |  |  |
| 542418 |  |  |
| 512886 |  |  |

|          |                    |
|----------|--------------------|
|          | 12m<br>(4m x 3seg) |
|          | 4m                 |
|          | 180                |
|          | 50+10<br>flashing  |
| <b>W</b> | 11W                |
|          | 3,5W               |
|          | 100m               |

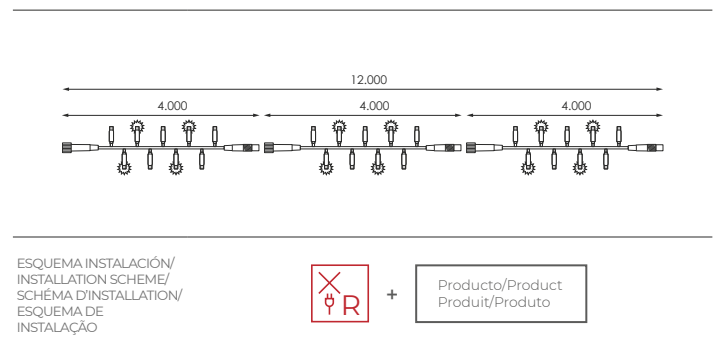

Accesorios (NO Incluidos) / Accessoires (NOT Included) / Accessories (NON Inclus) / Acessórios (NÃO Incluso)

+ INFO PAG. 418

995092  
Cable alimentación Negro

977722  
Cable alimentación Blanco

# STRING **PLUS** 180

## Flashing Cápsula Mate

|           |               |
|-----------|---------------|
|           | 230V dc       |
| <b>Hz</b> | 50-60Hz       |
|           | CII           |
|           | 1 CANAL       |
|           | IP65          |
|           | -20°C~+60 °C  |
|           | 1,15kg (N.W.) |
|           | NO INC.       |
|           | 10ud          |



SMART  
LINK

Santa Brígida  
Gran Canarias

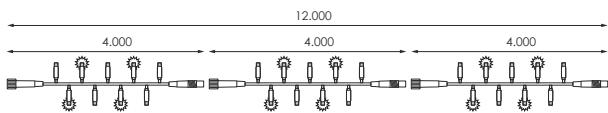

ESQUEMA INSTALACIÓN/  
INSTALLATION SCHEME/  
SCHEMA D'INSTALLATION/  
ESQUEMA DE  
INSTALAÇÃO



+

Producto/Product  
Produit/Produto

|          |                    |
|----------|--------------------|
|          | 12m<br>(4m x 3seg) |
|          | 4m                 |
|          | 180                |
|          | 50+10<br>flashing  |
| <b>W</b> | 11W                |
|          | 3,5W               |
|          | 100m               |

|        |  |  |
|--------|--|--|
|        |  |  |
| 146234 |  |  |
| 514460 |  |  |
| 977661 |  |  |
| 977678 |  |  |
| 977685 |  |  |
| 388184 |  |  |

Accesorios (NO Incluidos) / Accessoires (NOT Included) / Accessories (NON Inclus) / Acessórios (NÃO Incluso)

+ INFO PAG. 418

995092

Cable alimentación Negro

977722

Cable alimentación Blanco

# Cluster Light

## Fall Lite 1m



SMART  
LINK

⚡ 230V

Hz 50-60Hz

□ CII

☺ 1 CANAL

°° IP65

🌡 -20°C~+60 °C

📊 1,5kg (N.W.)

✗ NO INC.

☑ INC.

📏 10ud



PRODUCTO



PROYECTO



C/ de la Industria  
Guernica, Vizcaya

|        |  |  |
|--------|--|--|
|        |  |  |
| 388191 |  |  |
| 388207 |  |  |

|   |                  |
|---|------------------|
| ↔ | 1m               |
| ∅ | 6cm              |
| ☀ | 50               |
| W | 2W               |
| ✗ | NO<br>Empalmable |

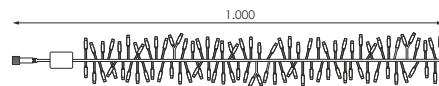

ESQUEMA INSTALACIÓN/  
INSTALLATION SCHEME/  
SCHEMA D'INSTALLATION/  
ESQUEMA DE  
INSTALAÇÃO



+

Producto/Product  
Produit/Produto

Accesorios (NO Incluidos) / Accessoires (NOT Included) / Accessories (NON Inclus) / Acessórios (NÃO Incluso)

+ INFO PAG. 418

193061

Cable alimentación Negro

193078

Cable alimentación Blanco

# Cluster Light

## Fall Lite 3m

SMART  
LINK 



ESQUEMA INSTALACIÓN/  
INSTALLATION SCHEME/  
SCHEMA D'INSTALLATION/  
ESQUEMA DE  
INSTALAÇÃO



+

Producto/Product  
Produit/Produto



3m



6cm



150

W

4,5W



NO  
Empalmable



192057



388214



Accesorios (NO Incluidos) / Accessoires (NOT Included) / Accessories (NON Inclus)/ Acessórios (NÃO Incluso)

+ INFO PAG. 418

193061

Cable alimentación Negro

193078

Cable alimentación Blanco

# Cluster Light

## Fall Lite 5m

SMART  
LINK 



ESQUEMA INSTALACIÓN/  
INSTALLATION SCHEME/  
SCHEMA D'INSTALLATION/  
ESQUEMA DE  
INSTALAÇÃO



+

Producto/Product  
Produit/Produto



5m



6cm



250

W

10,2W



NO  
Empalmable



192064



388221



Accesorios (NO Incluidos) / Accessoires (NOT Included) / Accessories (NON Inclus)/ Acessórios (NÃO Incluso)

+ INFO PAG. 418

193061

Cable alimentación Negro

193078

Cable alimentación Blanco



# Cluster Light

## Flashing

SMART  
LINK 



Gran Hotel Los Abetos  
Santiago de Compostela

 230V dc

 50-60Hz

 CII

 IP65

 -20°C~+60 °C

 1,4kg (N.W.)

 NO INC.

 10ud



192026



192033



2m



160+40  
flashing

W

15W



7sets

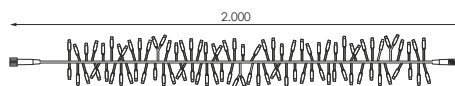

ESQUEMA INSTALACIÓN/  
INSTALLATION SCHEME/  
SCHEMA D'INSTALLATION/  
ESQUEMA DE  
INSTALAÇÃO



+

Producto/Product  
Produit/Produto

Accesorios (NO Incluidos) / Accessoires (NOT Included) / Accessories (NON Inclus) / Acessórios (NÃO Incluso)









+ INFO PAG. 418

995092

Cable alimentación Negro

# Techo de Luz **SCREENLIGHT**

Flashing

|   |               |
|---|---------------|
|  | 230V dc       |
| <b>Hz</b>   | 50-60Hz       |
|  | CII           |
|  | 1 CANAL       |
|  | IP65          |
|  | -20°C~+60 °C  |
|  | 13,5kg (N.W.) |
|  | NO INC.       |
|  | 1ud           |

**N**/ \*1 Led flashing cada 6 leds.  
**E**/ \*1 Led flashing each 6 leds.  
**F**/ \*1 Led clignotant chaque 6 leds.  
**P**/ \*1 Led piscando cada 6 leds.



SMART  
LINK 



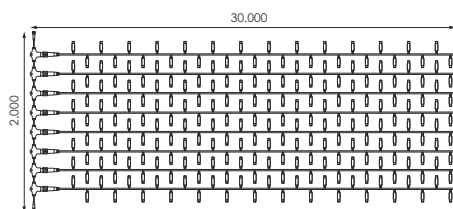









Guadalupe  
Cáceres



ESQUEMA INSTALACIÓN/  
INSTALLATION SCHEME/  
SCHEMA D'INSTALLATION/  
ESQUEMA DE  
INSTALAÇÃO



+ Producto/Product  
Produit/Produto

|   |                   |   |   |   |
|---|-------------------|---|---|---|
|  | 2x30m             |  |  |  |
|  | 8                 | 386128  |  |  |
|  | 792               | 386135  |  |  |
|  | 83+16<br>flashing |   |   |   |
| <b>W</b>  | 59W               |   |   |   |
|  | NO<br>Empalmable  |   |   |   |

Accesorios (NO Incluidos) / Accessoires (NOT Included) / Accessories (NON Inclus) / Acessórios (NÃO Incluso)

+ INFO PAG. 418

995092

Cable alimentación Negro



# Techo de Luz



|    |               |
|----|---------------|
| ⚡  | 12V           |
| Hz | 50-60Hz       |
| ◇  | CIII          |
| ⊙  | 1 CANAL       |
| ⊙  | IP44          |
| kg | 13,5kg (N.W.) |
| TR | INC.          |
| ⊙  | 1ud           |

CC. La Villa  
La Orotava (Tenerife)

|        |     |    |
|--------|-----|----|
|        | 💡   | ⊙  |
| 546621 | LED | 👁️ |
| 546614 | LED | 👁️ |

|   |                  |
|---|------------------|
| ↔ | 2x30m            |
| ⊙ | 7                |
| 💡 | 693              |
| 🔊 | 99               |
| W | 100W             |
| ✖ | NO<br>Empalmable |

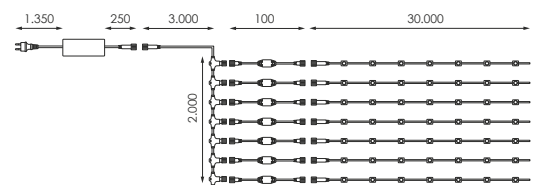

Accesorios (NO Incluidos) / Accessoires (NOT Included) / Accessories (NON Inclus) / Acessórios (NÃO Incluso)

+ INFO PAG. 418

499507

Protector sobretensiones y termorretráctil

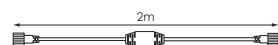

# Techo de Luz

## Flashing

|           |               |
|-----------|---------------|
|           | 12V           |
| <b>Hz</b> | 50-60Hz       |
|           | CIII          |
|           | 1 CANAL       |
|           | IP44          |
|           | 13,5kg (N.W.) |
|           | INC.          |
|           | 1ud           |

**Ñ/** \*1 Led flashing cada 9 leds.  
**E/** \*1 Led flashing each 9 leds.  
**F/** \*1 Led clignotant chaque 9 leds.  
**P/** \*1 Led piscando cada 9 leds.



Torrijos  
Toledo

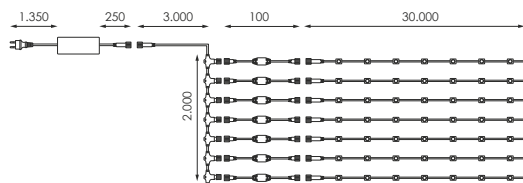

|          |                   |        |  |  |
|----------|-------------------|--------|--|--|
|          | 2x30m             |        |  |  |
|          | 7                 | 391375 |  |  |
|          | 693               | 391382 |  |  |
|          | 88+11<br>flashing |        |  |  |
| <b>W</b> | 100W              |        |  |  |
|          | NO<br>Empalmable  |        |  |  |

Accesorios (NO Incluidos) / Accessoires (NOT Included) / Accessories (NON Inclus) / Acessórios (NÃO Incluso)

+ INFO PAG. 418

499507

Protector sobretensiones y termo-retráctil

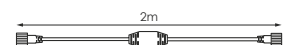



















# SCREENLIGHT 300





24V



Hotel Marconfort  
Benidorm

|   |              |
|---|--------------|
|  | 24V dc       |
| <b>Hz</b>   | 50-60Hz      |
|  | CIII         |
|  | 1 CANAL      |
|  | IP65         |
|  | -20°C~+60 °C |
|  | 3kg (N.W.)   |
|  | NO INC.      |
|  | 5ud          |

|   |   |   |
|---|---|---|
|  |    |  |
| 192132  |   |  |
| 192149  |   |  |

|   |                      |
|---|----------------------|
|  | 2x1,5m               |
|  | 20                   |
|  | 300                  |
|  | 15                   |
| <b>W</b>  | 14,7W                |
|  | Máx. 5 sets en serie |

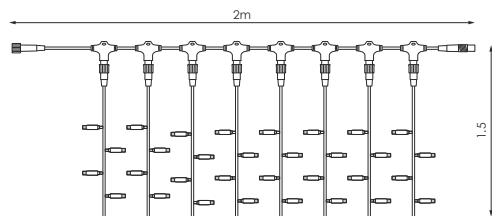

ESQUEMA INSTALACIÓN/  
INSTALLATION SCHEME/  
SCHEMA D'INSTALLATION/  
ESQUEMA DE  
INSTALAÇÃO

 + Producto/Product  
Produit/Produto

## Aviso/Warning/Avertissement/Aviso

Ñ/ Uso **OBLIGATORIO** de fuente de alimentación.

E/ You **MUST USE** the power supply.

F/ L'utilisation **OBLIGATOIRE** du l'alimentation

P/ Uso **OBRIGATÓRIO** fonte de alimentação.

## Accesorios (NO Incluidos) / Accessoires (NOT Included) / Accessoires (NON Inclus)/ Acessórios (NÃO Incluso)

+ INFO PAG. 418

Ñ/ Fuente de alimentación **NO INCLUIDA**

488440  
Fuente alimentación 30W 24V

488457  
Fuente alimentación 60W 24V

488464  
Fuente alimentación 100W 24V

E/ Power supply **NOT INCLUDED**

481687  
Fuente alimentación 150W 24V









571968  
Fuente alimentación 200W 24V

F/ Alimentation **NON INCLUSE**

P/ Fonte de alimentação **NÃO INCLUIDO**

# SCREENLIGHT 600

24V

|   |              |
|---|--------------|
|  | 24V dc       |
| Hz  | 50-60Hz      |
|   | CIII         |
|   | 1 CANAL      |
|   | IP65         |
|  | -20°C~+60 °C |
|   | 7kg (N.W.)   |
|   | NO INC.      |
|   | 2ud          |



CC. Ferial Plaza  
Guadalajara

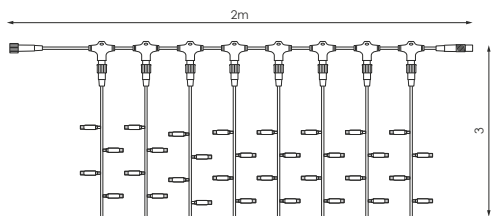







ESQUEMA INSTALACIÓN/  
INSTALLATION SCHEME/  
SCHEMA D'INSTALLATION/  
ESQUEMA DE  
INSTALAÇÃO



Producto/Product  
Produit/Produto

|   |                         |
|---|-------------------------|
|  | 2x3m                    |
|  | 20                      |
|  | 600                     |
|  | 30                      |
| W   | 28,5W                   |
|  | Máx. 4 sets<br>en serie |

|   |   |   |
|---|---|---|
|  |  |  |
| 192156  |  |  |
| 192163  |  |  |

Aviso/Warning/Avertissement/Aviso

Ñ/ Uso **OBLIGATORIO** de fuente de alimentación.

E/ You **MUST USE** the power supply.

F/ L'utilisation **OBLIGATOIRE** du l'alimentation

P/ Uso **OBRIGATÓRIO** fonte de alimentação.

Accesorios (NO Incluidos) / Accessoires (NOT Included) / Accessories (NON Inclus)/ Acessórios (NÃO Incluso)

+ INFO PAG. 418

Ñ/ Fuente de alimentación **NO INCLUIDA**

488440

Fuente alimentación 30W 24V

E/ Power supply **NOT INCLUDED**

481687

Fuente alimentación 150W 24V

F/ Alimentation **NON INCLUSE**

P/ Fonte de alimentação **NÃO INCLUÍDO**

488457

Fuente alimentación 60W 24V

571968

Fuente alimentación 200W 24V

488464

Fuente alimentación 100W 24V









# SCREENLIGHT 300























SMART LINK 



Guadalupe  
Caceres

|   |              |
|---|--------------|
|  | 230V dc      |
| <b>Hz</b>   | 50-60Hz      |
|  | CII          |
|  | 1 CANAL      |
|  | IP65         |
|  | -20°C~+60 °C |
|  | 3kg (N.W.)   |
|  | NO INC.      |
|  | 5ud          |

|   |   |   |
|---|---|---|
|  |    |  |
| 953108  |   |  |
| 995177  |   |  |
| 995184  |   |  |
| 953115  |   |  |

|   |                           |
|---|---------------------------|
|  | 2x1,5m                    |
|  | 20<br>(2 tiras = 1 serie) |
|  | 300                       |
|  | 15                        |
| <b>W</b>  | 30W                       |
|  | 10sets                    |

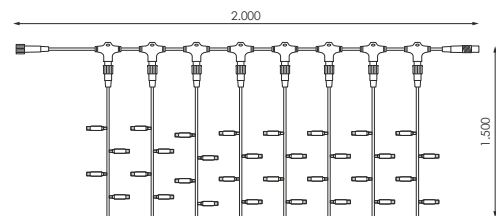

ESQUEMA INSTALACIÓN/  
INSTALLATION SCHEME/  
SCHEMA D'INSTALLATION/  
ESQUEMA DE  
INSTALAÇÃO



+

Producto/Product  
Produit/Produto

Accesorios (NO Incluidos) / Accessoires (NOT Included) / Accessories (NON Inclus) / Acessórios (NÃO Incluso)









+ INFO PAG. 418

995092  
Cable alimentación Negro

977722  
Cable alimentación Blanco



# SCREENLIGHT 600

|  |              |
|--|--------------|
|  | 230V dc      |
| <b>Hz</b>  | 50-60Hz      |
|  | CII          |
|  | 1 CANAL      |
|  | IP65         |
|  | -20°C~+60 °C |
|  | 4,7kg (N.W.) |
|  | NO INC.      |
|  | 2ud          |

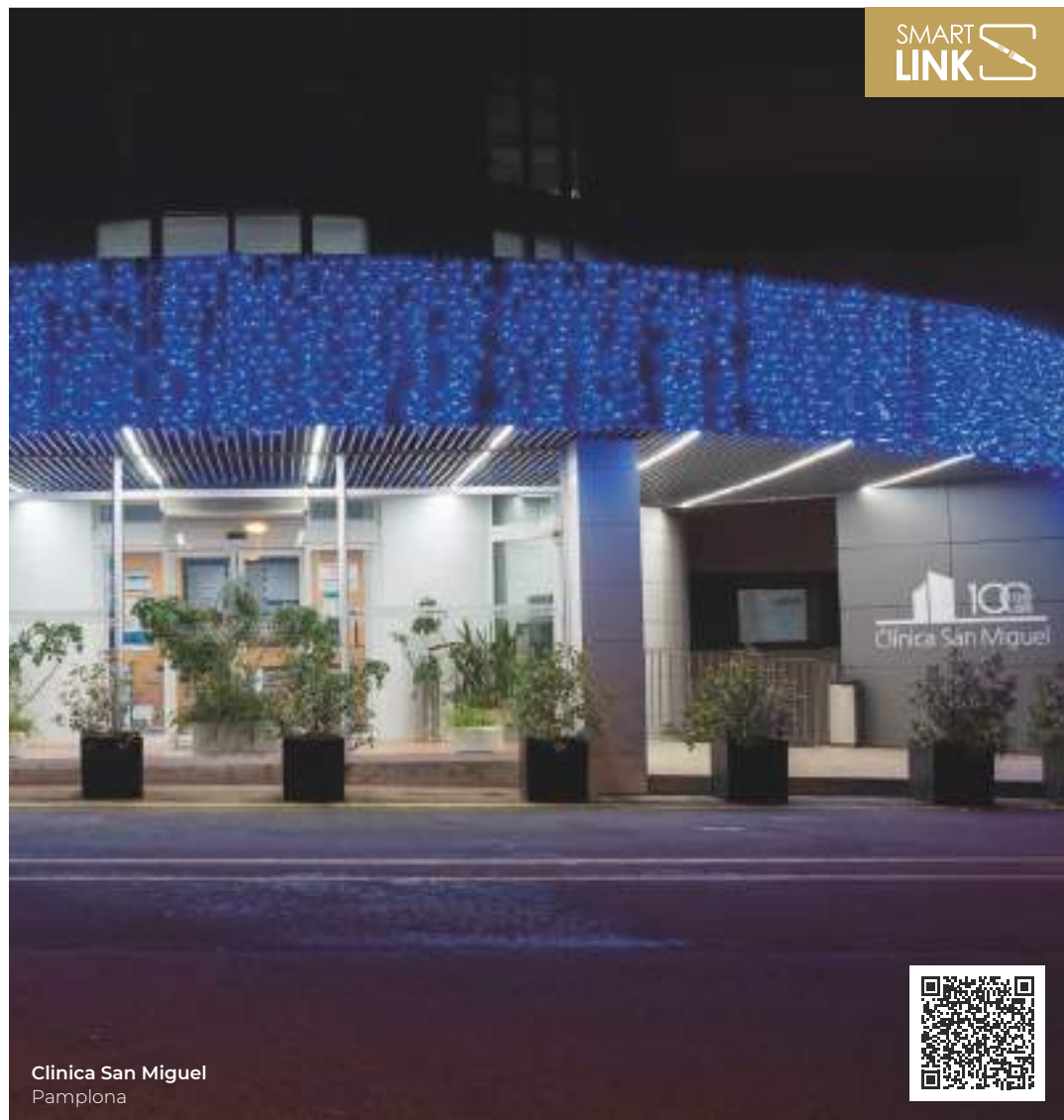

Clinica San Miguel  
Pamplona

[GRÁFICOS: Unidades en mm/ GRÁFICOS: Units in mm/ GRAPHICS: Units in mm/ GRÁFICOS: Unidades em mm]

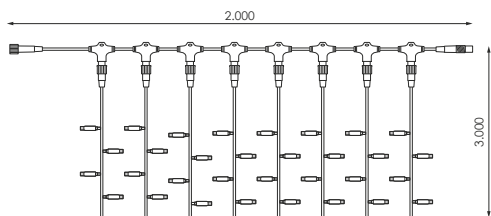





















ESQUEMA INSTALACIÓN/  
INSTALLATION SCHEME/  
SCHEMA D'INSTALLATION/  
ESQUEMA DE  
INSTALAÇÃO



+

Producto/Product  
Produit/Produto

|   |                           |
|---|---------------------------|
|  | 2x3m                      |
|  | 20<br>(2 tiras = 1 serie) |
|  | 600                       |
|  | 30                        |
| <b>W</b>  | 36,5W                     |
|  | 7sets                     |

|   |   |   |
|---|---|---|
|  |    |  |
| 953153  |   |  |
| 995191  |   |  |
| 995207  |   |  |
| 163712  |   |  |

Accesorios (NO Incluidos) / Accessoires (NOT Included) / Accessories (NON Inclus) / Acessórios (NÃO Incluso)

+ INFO PAG. 418

995092

Cable alimentación Negro

977722

Cable alimentación Blanco

# SCREENLIGHT 1200

SMART  
LINK 

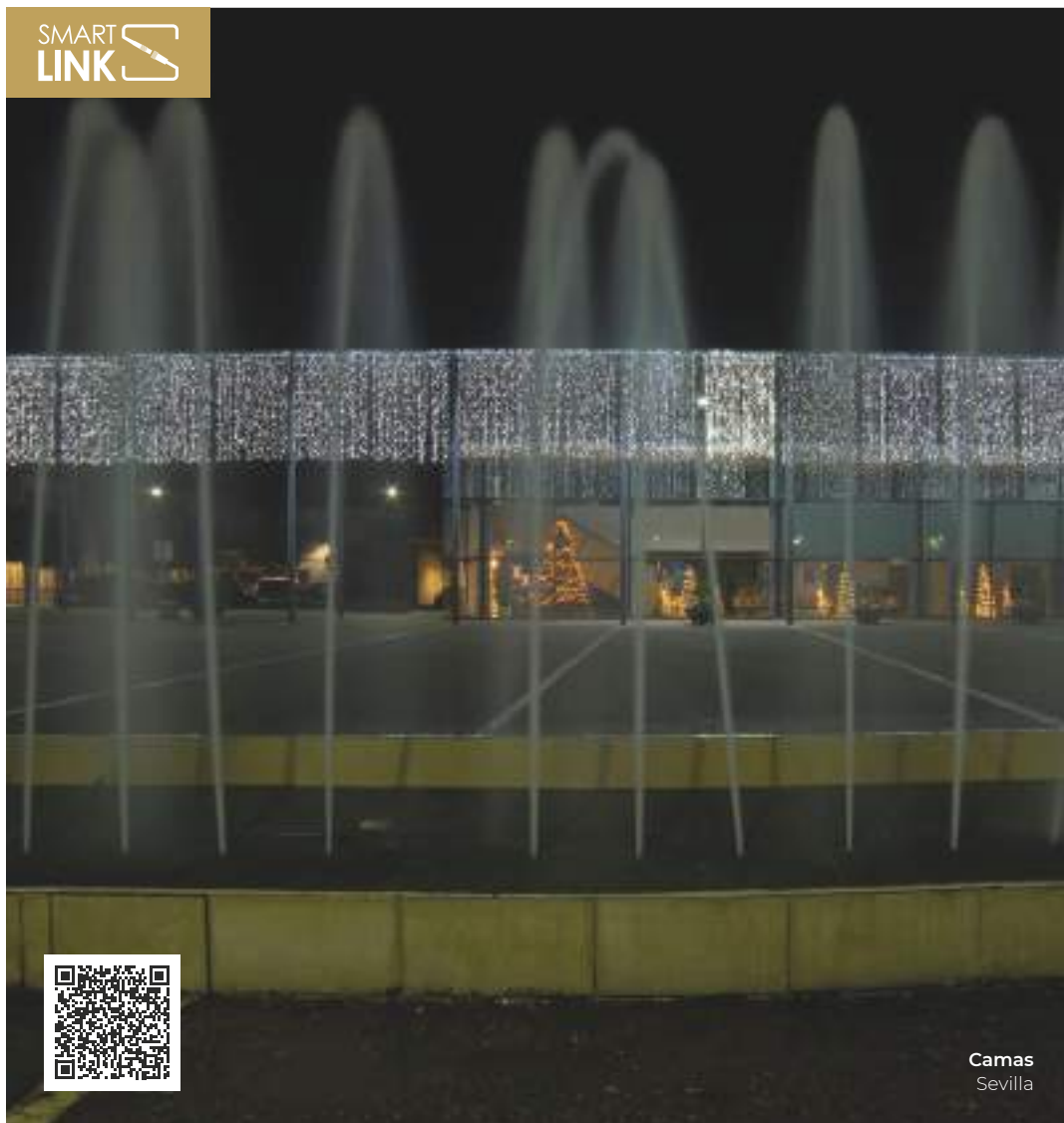

Camas  
Sevilla

 230V dc

**Hz** 50-60Hz

 CII

 1 CANAL

 IP65















 -20°C~+60 °C

 8,7kg (N.W.)

 NO INC.

 2ud



|   |   |   |
|---|---|---|
|  |    |  |
| 953177  |   |  |
| 163569  |   |  |
| 163576  |   |  |
| 092609  |   |  |

|   |       |
|---|-------|
|  | 2x6m  |
|  | 20    |
|  | 1200  |
|  | 60    |
| <b>W</b>  | 74W   |
|  | 3sets |

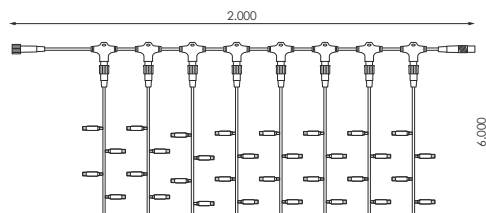

ESQUEMA INSTALACIÓN/  
INSTALLATION SCHEME/  
SCHEMA D'INSTALLATION/  
ESQUEMA DE  
INSTALAÇÃO



+

Producto/Product  
Produit/Produto

Accesorios (NO Incluidos) / Accessoires (NOT Included) / Accessories (NON Inclus) / Acessórios (NÃO Incluso)

+ INFO PAG. 418









995092

Cable alimentación Negro

977722

Cable alimentación Blanco

# SCREENLIGHT 1800

|   |               |
|---|---------------|
|  | 230V dc       |
| <b>Hz</b>   | 50-60Hz       |
|  | CII           |
|  | 1 CANAL       |
|  | IP65          |
|  | -20°C~+60 °C  |
|  | 13,5kg (N.W.) |
|  | NO INC.       |
|  | 1ud           |



SMART  
LINK 

San Brígida  
Gran Canarias

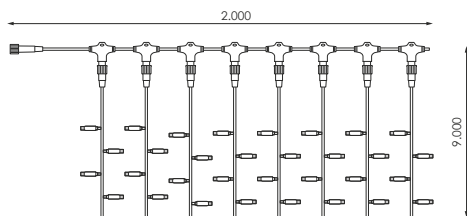













ESQUEMA INSTALACIÓN/  
INSTALLATION SCHEME/  
SCHEMA D'INSTALLATION/  
ESQUEMA DE  
INSTALAÇÃO



+

Producto/Product  
Produit/Produto

|   |                  |
|---|------------------|
|  | 2x9m             |
|  | 20               |
|  | 1800             |
|  | 90               |
| <b>W</b>  | 150W             |
|  | NO<br>Empalmable |

|   |   |   |
|---|---|---|
|  |  |  |
| 953191  |  |  |
| 146241  |  |  |

Accesorios (NO Incluidos) / Accessoires (NOT Included) / Accessories (NON Inclus) / Acessórios (NÃO Incluso)

+ INFO PAG. 418

977722

Cable alimentación Blanco











# SCREENLIGHT 300

Flashing



















SMART LINK 

|   |              |
|---|--------------|
|  | 230V dc      |
| <b>Hz</b>   | 50-60Hz      |
|  | CII          |
|  | 1 CANAL      |
|  | IP65         |
|  | -20°C~+60 °C |
|  | 3kg (N.W.)   |
|  | NO INC.      |
|  | 5ud          |



Arucas  
Canarias

|   |   |   |
|---|---|---|
|  |    |  |
| 146258  |    |  |
| 146456  |    |  |

|   |                           |
|---|---------------------------|
|  | 2x1,5m                    |
|  | 20<br>(2 tiras = 1 serie) |
|  | 300                       |
|  | 13+2<br>flashing          |
| <b>W</b>  | 32W                       |
|  | 10sets                    |

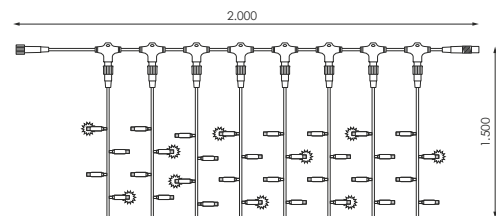

ESQUEMA INSTALACIÓN/  
INSTALLATION SCHEME/  
SCHEMA D'INSTALLATION/  
ESQUEMA DE  
INSTALAÇÃO



+

Producto/Product  
Produit/Produto

Accesorios (NO Incluidos) / Accessoires (NOT Included) / Accessories (NON Inclus) / Acessórios (NÃO Incluso)

+ INFO PAG. 418

995092









Cable alimentación Negro

977722

Cable alimentación Blanco

# SCREENLIGHT 600

Flashing

|  |              |
|--|--------------|
|  | 230V dc      |
| <b>Hz</b>  | 50-60Hz      |
|  | CII          |
|  | 1 CANAL      |
|  | IP65         |
|  | -20°C~+60 °C |
|  | 4,7kg (N.W.) |
|  | NO INC.      |
|  | 2ud          |



SMART LINK 



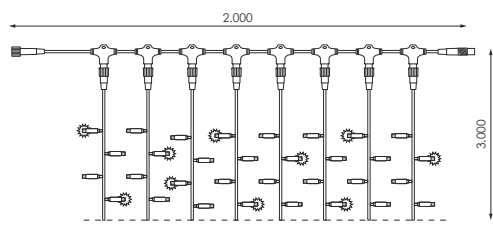

Restaurante La Santina  
Galapagar, Madrid









ESQUEMA INSTALACIÓN/  
INSTALLATION SCHEME/  
SCHEMA D'INSTALLATION/  
ESQUEMA DE  
INSTALAÇÃO



+ Producto/Product  
Produit/Produto

|   |                           |
|---|---------------------------|
|  | 2x3m                      |
|  | 20<br>(2 tiras = 1 serie) |
|  | 600                       |
|  | 26+4<br>flashing          |
| <b>W</b>  | 38W                       |
|  | 7sets                     |

|   |   |   |
|---|---|---|
|  |  |  |
| 163606  |  |  |
| 146555  |  |  |

Accesorios (NO Incluidos) / Accessoires (NOT Included) / Accessories (NON Inclus) / Acessórios (NÃO Incluso)

+ INFO PAG. 418

995092  
Cable alimentación Negro

977722  
Cable alimentación Blanco

[GRÁFICOS: Unidades en mm] / GRAPHICS: Units in mm / GRÁFICOS: Unidades em mm / GRÁFICOS: Unidades em mm



# SCREENLIGHT 1200

Flashing



 230V dc

 50-60Hz

 CII

 1 CANAL

 IP65

 -20°C~+60 °C











 8,7kg (N.W.)





 NO INC.

 2ud



CC. Mendibil  
Irún

|   |   |   |
|---|---|---|
|  |    |  |
| 163613  |    |  |
| 146562  |    |  |

|   |               |
|---|---------------|
|  | 2x6m          |
|  | 20            |
|  | 1200          |
|  | 54+6 flashing |
| <b>W</b>  | 73W           |
|  | 3sets         |

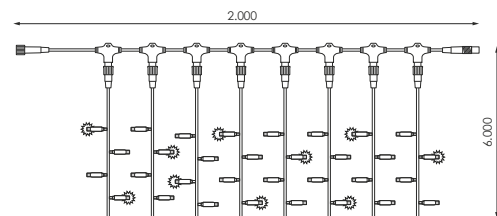

ESQUEMA INSTALACIÓN/  
INSTALLATION SCHEME/  
SCHEMA D'INSTALLATION/  
ESQUEMA DE  
INSTALAÇÃO



+

Producto/Product  
Produit/Produto

Accesorios (NO Incluidos) / Accessoires (NOT Included) / Accessories (NON Inclus) / Acessórios (NÃO Incluso)

+ INFO PAG. 418

995092

Cable alimentación Negro









977722

Cable alimentación Blanco



# SCREENLIGHT 1800

Flashing

|   |               |
|---|---------------|
|  | 230V dc       |
| <b>Hz</b>   | 50-60Hz       |
|  | CII           |
|  | 1 CANAL       |
|  | IP65          |
|  | -20°C~+60 °C  |
|  | 13,5kg (N.W.) |
|  | NO INC.       |
|  | 1ud           |



SMART LINK 



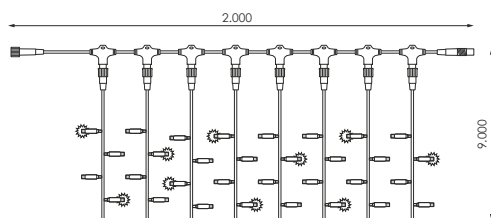

Bollullos de la Migración  
Sevilla













ESQUEMA INSTALACIÓN/  
INSTALLATION SCHEME/  
SCHEMA D'INSTALLATION/  
ESQUEMA DE  
INSTALAÇÃO



+ Producto/Product  
Produit/Produto

|   |                   |
|---|-------------------|
|  | 2x9m              |
|  | 20                |
|  | 1800              |
|  | 80+10<br>flashing |
| <b>W</b>  | 150W              |
|  | NO<br>Empalmable  |

|   |   |   |
|---|---|---|
|  |    |  |
| 441698  |    |  |
| 441704  |    |  |

Accesorios (NO Incluidos) / Accessoires (NOT Included) / Accessories (NON Inclus) / Acessórios (NÃO Incluso)

+ INFO PAG. 418

995092

Cable alimentación Negro









977722









Cable alimentación Blanco





# SCREENLIGHT 300

Dual



|   |              |
|---|--------------|
|  | 230V dc      |
| <b>Hz</b>   | 50-60Hz      |
|  | CII          |
|  | 1 CANAL      |
|  | IP44         |
|  | -20°C~+60 °C |
|  | 3kg (N.W.)   |
|  | NO INC.      |
|  | 5ud          |

|   |   |   |
|---|---|---|
|  |  |  |
| 192071  |  |  |
| 192088  |  |  |
| 192095  |  |  |

|   |             |
|---|-------------|
|  | 2x1,5m      |
|  | 20          |
|  | 300         |
|  | 15          |
| <b>W</b>  | 33W         |
|  | *Accesorios |

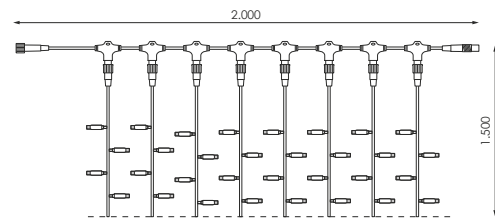

ESQUEMA INSTALACIÓN/  
INSTALLATION SCHEME/  
SCHÉMA D'INSTALLATION/  
ESQUEMA DE  
INSTALAÇÃO



## Aviso/Warning/Avertissement/Aviso

**Ñ**/ Los efectos de cambio de color solo funcionan con el controlador que es de **USO OBLIGATORIO**.

**E**/ The color change effects only work with the controller that is **OBLIGATORY**.

**F**/ Les effets de changement de couleur fonctionnent uniquement avec le contrôleur qui est **OBLIGATOIRE**.

**P**/ Os efeitos de mudança de cor funcionam apenas com o controlador que é **USO OBLIGATORIO**.

## Accesorios (NO Incluidos) / Accessoires (NOT Included) / Accessories (NON Inclus)/ Acessórios (NÃO Incluso)



+ INFO PAG. 418

**Ñ**/ La máxima longitud por alimentación, dependerá del controlador a utilizar. Controlador **NO INCLUIDO**.

**E**/ Maximum length for power, will depend on the driver to use. Controller **NOT INCLUDED**.

**F**/ Longueur maximale pour le pouvoir, dépendra le pilote à utiliser. Contrôleur **NON INCLUS**.

**P**/ Comprimento máximo para o poder, vai depender do driver para uso. Controlador **NÃO INCLUIDO**.

|                                   |   |   |
|-----------------------------------|---|---|
| 971072                            |  |  |
| Controlador 4 funciones 6A        |   |   |
| 391559                            |   |   |
| Controlador 8 funciones 2A blanco |   |   |

|        |                   |
|--------|-------------------|
| 971072 | max. 7 set/salida |
| 391559 | 7 sets            |











El Berrueco  
Madrid















# SCREENLIGHT 250

Fall Lite



|   |              |
|---|--------------|
|  | 230V dc      |
| <b>Hz</b>   | 50-60Hz      |
|  | CII          |
|  | 1 CANAL      |
|  | IP65         |
|  | -20°C~+60 °C |
|  | 3kg (N.W.)   |
|  | NO INC.      |
|  | 5ud          |

|   |   |   |
|---|---|---|
|  |  |  |
| 388238  |  |  |
| 388245  |  |  |

|   |        |
|---|--------|
|  | 2x1m   |
|  | 5      |
|  | 250    |
|  | 50     |
| <b>W</b>  | 5,5W   |
|  | 15sets |

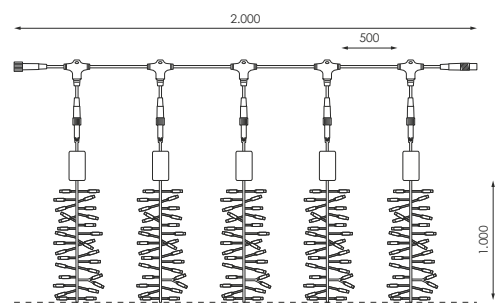

ESQUEMA INSTALACIÓN/  
INSTALLATION SCHEME/  
SCHEMA D'INSTALLATION/  
ESQUEMA DE  
INSTALAÇÃO



+

Producto/Product  
Produit/Produto

Accesorios (NO Incluidos) / Accessoires (NOT Included) / Accessories (NON Inclus)/ Acessórios (NÃO Incluso)









+ INFO PAG. 418

193078

Cable alimentación Blanco

# SCREEN Rain

2x2m







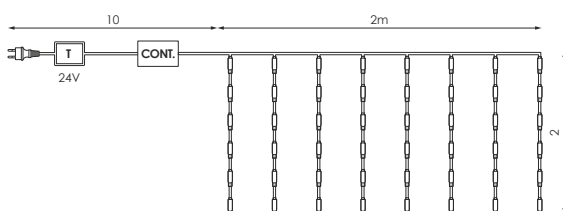

|   |              |
|---|--------------|
|  | 24V          |
| <b>Hz</b>   | 50-60Hz      |
|  | CIII         |
|  | 4 CANALES    |
|  | IP44         |
|  | -20°C~+60 °C |
|  | 3kg (N.W.)   |
|  | INC.         |
|  | 5ud          |

**Ñ/** Controlador efecto lluvia ajustable en velocidad **INCLUIDO**.  
**E/** Controller adjustable rain's effect in speed **INCLUDED**.  
**F/** Contrôleur effet vitesse réglable de pluie **INCLUS**.  
**P/** Controlador ajustável chuva na velocidade **INCLUÍDO**.



Fuensalida  
Toledo



|   |                  |   |   |   |
|---|------------------|---|---|---|
|  | 2x2m             |  |  |  |
|  | 16               | 441711  | <b>LED</b>  |  |
|  | 512              |   |   |   |
|  | 32               |   |   |   |
| <b>W</b>  | 17W              |   |   |   |
|  | NO<br>Empalmable |   |   |   |

# ICICLE<sup>®</sup> 114



|           |              |
|-----------|--------------|
|           | 230V dc      |
| <b>Hz</b> | 50-60Hz      |
|           | CII          |
|           | 1 CANAL      |
|           | IP65         |
|           | -20°C~+60 °C |
|           | 1kg (N.W.)   |
|           | NO INC.      |
|           | 10ud         |

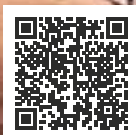

CC. Lagoh  
Sevilla

|        |  |  |
|--------|--|--|
|        |  |  |
| 977692 |  |  |
| 146364 |  |  |
| 163620 |  |  |
| 163637 |  |  |

|          |                         |
|----------|-------------------------|
|          | 3x0,5m<br>(1,5m x 2seg) |
|          | Nº 2                    |
|          | 114                     |
|          | 57                      |
| <b>W</b> | 8W                      |
|          | 20sets                  |

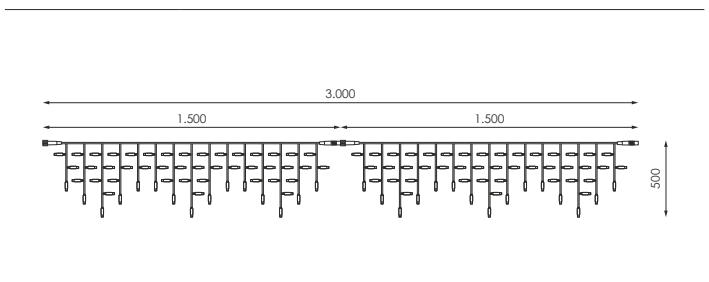

ESQUEMA INSTALACIÓN/  
INSTALLATION SCHEME/  
SCHEMA D'INSTALLATION/  
ESQUEMA DE  
INSTALAÇÃO



Accesorios (NO Incluidos) / Accessoires (NOT Included) / Accessories (NON Inclus) / Acessórios (NÃO Includo)  
+ INFO PAG. 418

995092  
Cable alimentación Negro

977722  
Cable alimentación Blanco



|           |              |
|-----------|--------------|
|           | 230V dc      |
| <b>Hz</b> | 50-60Hz      |
|           | CII          |
|           | 1 CANAL      |
|           | IP65         |
|           | -20°C~+60 °C |
|           | 1,7kg (N.W.) |
|           | NO INC.      |
|           | 10ud         |

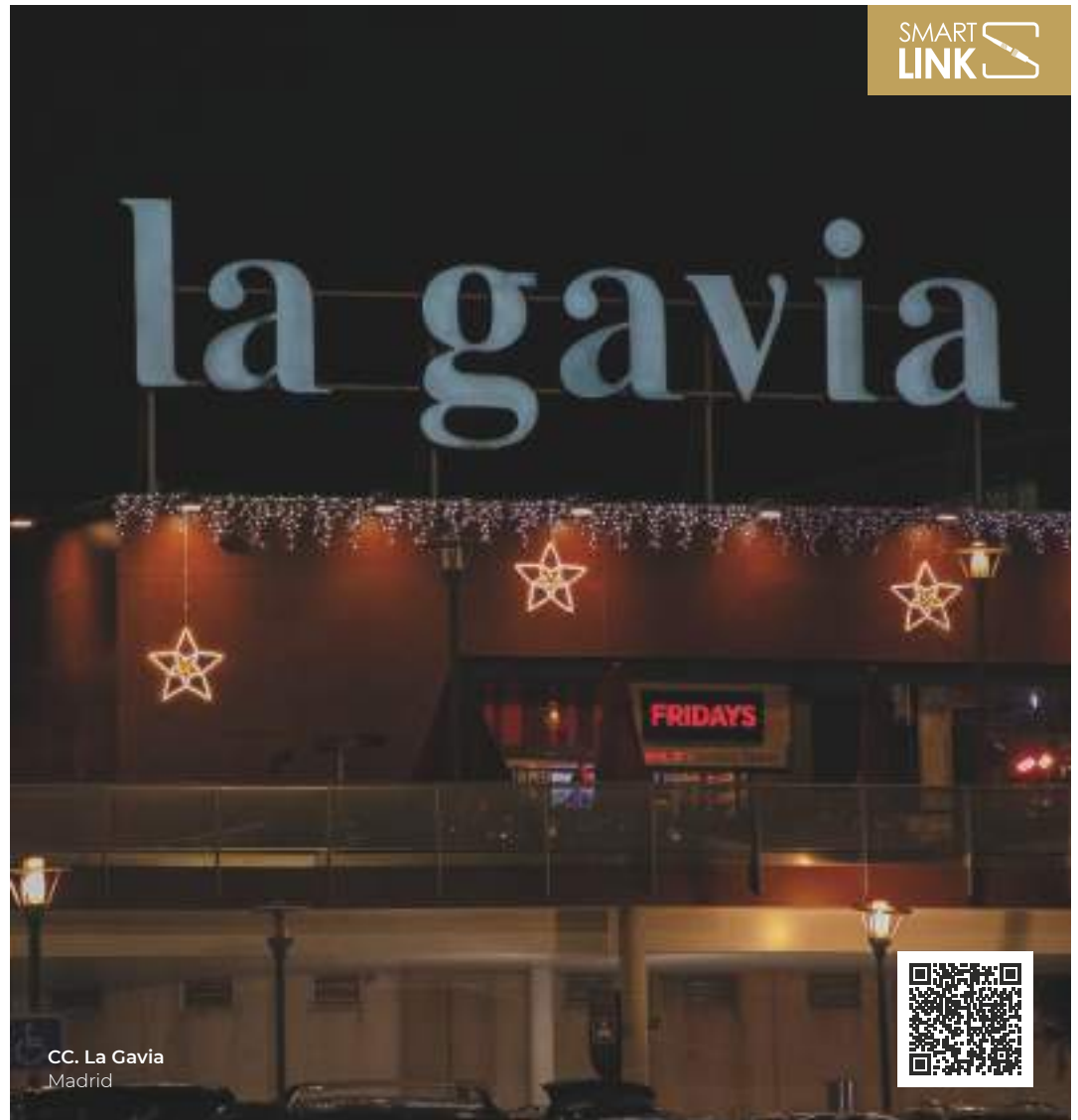

CC. La Gavia  
Madrid

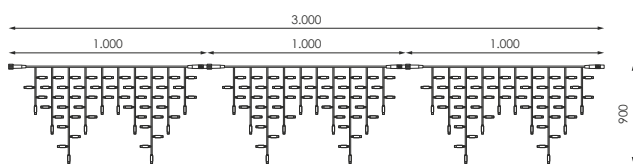

ESQUEMA INSTALACIÓN/  
INSTALLATION SCHEME/  
SCHEMA D'INSTALLATION/  
ESQUEMA DE  
INSTALAÇÃO



+

Producto/Product  
Produit/Produto

|          |                       |
|----------|-----------------------|
|          | 3x0,9m<br>(1m x 3seg) |
|          | 3                     |
|          | 174                   |
|          | 58                    |
| <b>W</b> | 12W                   |
|          | 15sets                |

|        |  |  |
|--------|--|--|
|        |  |  |
| 163644 |  |  |
| 163552 |  |  |
| 161305 |  |  |
| 543026 |  |  |

Accesorios (NO Incluidos) / Accessoires (NOT Included) / Accessories (NON Inclus)/ Acessórios (NÃO Incluso)

+ INFO PAG. 418

995092

Cable alimentación Negro

977722

Cable alimentación Blanco

# ICICLE<sup>®</sup> 304



SMART  
LINK

|           |              |
|-----------|--------------|
|           | 230V dc      |
| <b>Hz</b> | 50-60Hz      |
|           | CII          |
|           | 1 CANAL      |
|           | IP65         |
|           | -20°C~+60 °C |
|           | 2,7kg (N.W.) |
|           | NO INC.      |
|           | 6ud          |



Santa Brígida  
Gran Canarias

| 163675 |  |  |  |
|--------|--|--|--|
| 163682 |  |  |  |
| 163699 |  |  |  |
| 163705 |  |  |  |

|          |                       |
|----------|-----------------------|
|          | 4x1,5m<br>(1m x 4seg) |
|          | 4                     |
|          | 304                   |
|          | 76                    |
| <b>W</b> | 27,5W                 |
|          | 10sets                |

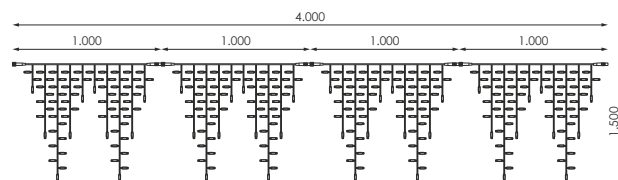

ESQUEMA INSTALACIÓN/  
INSTALLATION SCHEME/  
SCHEMA D'INSTALLATION/  
ESQUEMA DE  
INSTALAÇÃO



+

Producto/Product  
Produit/Produto

Accesorios (NO Incluidos) / Accessoires (NOT Included) / Accessories (NON Inclus) / Acessórios (NÃO Includo)

+ INFO PAG. 418

995092

Cable alimentación Negro

977722

Cable alimentación Blanco

# ICICLE 114

## Flashing

|           |              |
|-----------|--------------|
|           | 230V dc      |
| <b>Hz</b> | 50-60Hz      |
|           | CII          |
|           | 1 CANAL      |
|           | IP65         |
|           | -20°C~+60 °C |
|           | 1kg (N.W.)   |
|           | NO INC.      |
|           | 10ud         |



CC. Lagoh  
Sevilla

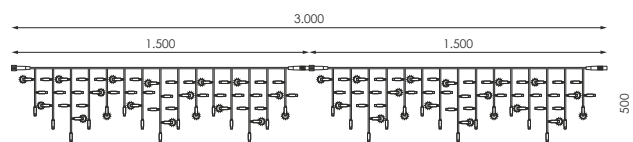

ESQUEMA INSTALACIÓN/  
INSTALLATION SCHEME/  
SCHEMA D'INSTALLATION/  
ESQUEMA DE  
INSTALAÇÃO



+ Producto/Product  
Produit/Produto

|          |                         |
|----------|-------------------------|
|          | 3x0,5m<br>(1,5m x 2seg) |
|          | 2                       |
|          | 114                     |
|          | 49+8<br>flashing        |
| <b>W</b> | 8,5W                    |
|          | 20sets                  |

|        |  |  |
|--------|--|--|
|        |  |  |
| 146388 |  |  |
| 146371 |  |  |
| 543019 |  |  |

Accesorios (NO Incluidos) / Accessoires (NOT Included) / Accessories (NON Inklus) / Acessórios (NÃO Includo)

+ INFO PAG. 418

995092

Cable alimentación Negro

977722

Cable alimentación Blanco











# ICICLE<sup>®</sup> 174

## Flashing























SMART LINK 

|   |              |
|---|--------------|
|  | 230V dc      |
| <b>Hz</b>   | 50-60Hz      |
|  | CII          |
|  | 1 CANAL      |
|  | IP65         |
|  | -20°C~+60 °C |
|  | 1,7kg (N.W.) |
|  | NO INC.      |
|  | 10ud         |



CC. Metroma  
Sevilla

|   |   |   |
|---|---|---|
|  |    |  |
| 146395  |    |  |
| 146401  |    |  |
| 543033  |    |  |

|   |                       |
|---|-----------------------|
|  | 3x0,9m<br>(1m x 3seg) |
|  | Nº 3                  |
|  | 174                   |
|  | 50+8<br>flashing      |
| <b>W</b>  | 12W                   |
|  | 15sets                |

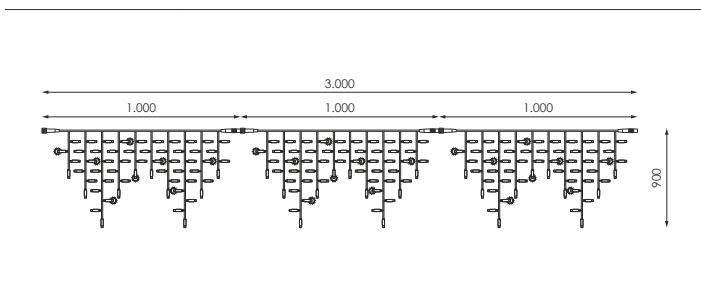

ESQUEMA INSTALACIÓN/  
INSTALLATION SCHEME/  
SCHEMA D'INSTALLATION/  
ESQUEMA DE  
INSTALAÇÃO



+

Producto/Product  
Produit/Produto

Accesorios (NO Incluidos) / Accessoires (NOT Included) / Accessories (NON Inclus) / Acessórios (NÃO Includo)

+ INFO PAG. 418









995092  
Cable alimentación Negro

977722  
Cable alimentación Blanco

# ICICLE 304

Flashing

SMART LINK

|   |              |
|---|--------------|
|  | 230V dc      |
| <b>Hz</b>   | 50-60Hz      |
|  | CII          |
|  | 1 CANAL      |
|  | IP65         |
|  | -20°C~+60 °C |
|  | 2,7kg (N.W.) |
|  | NO INC.      |
|  | 5ud          |



La Palma del Condado  
Huelva

[GRÁFICOS: Unidades en mm/ GRÁFICOS: Units in mm/ GRAPHICS: Units in mm/ GRÁFICOS: Unidades em mm]

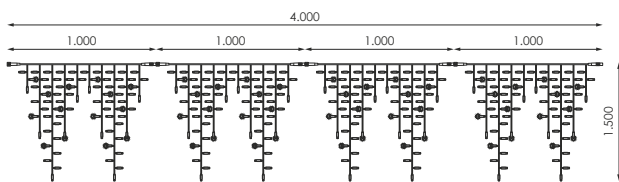













ESQUEMA INSTALACIÓN/  
INSTALLATION SCHEME/  
SCHEMA D'INSTALLATION/  
ESQUEMA DE  
INSTALAÇÃO



+

Producto/Product  
Produit/Produto

|   |                       |
|---|-----------------------|
|  | 4x1,5m<br>(1m x 4seg) |
|  | 4                     |
|  | 304                   |
|  | 66+10<br>flashing     |
| <b>W</b>  | 27,5W                 |
|  | 10sets                |

|   |   |   |
|---|---|---|
|  |  |  |
| 546591  |  |  |
| 546607  |  |  |

Accesorios (NO Incluidos) / Accessoires (NOT Included) / Accessories (NON Includo) / Acessórios (NÃO Includo)

+ INFO PAG. 418

995092

Cable alimentación Negro

977722

Cable alimentación Blanco

# Cascada

4m

|        |  |  |
|--------|--|--|
|        |  |  |
| 075824 |  |  |
| 192187 |  |  |
| 075817 |  |  |

|          |               |
|----------|---------------|
|          | 4m            |
|          | 5             |
|          | 480           |
|          | 96            |
| <b>W</b> | 26W           |
|          | NO Empalmable |

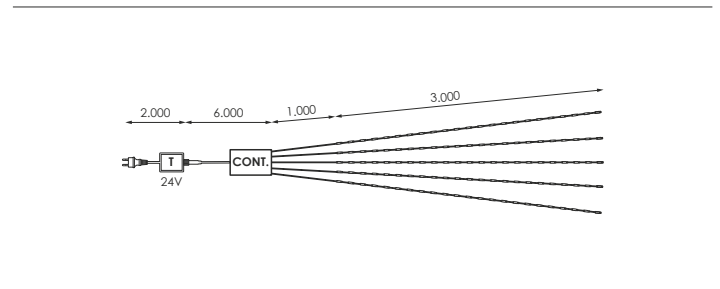

## Información/Information/Information/Informações

Ñ/ Controlador 8 funciones **INCLUIDO.**

E/ Controller 8 functions **IN-CLUDED.**

F/ Contrôleur 8 fonctions **INCLUS.**

P/ Controlador 8 funções **INCLUIDO.**

# Cascada

7m

|        |  |  |
|--------|--|--|
|        |  |  |
| 075848 |  |  |
| 192194 |  |  |
| 075831 |  |  |

|          |               |
|----------|---------------|
|          | 7m            |
|          | 5             |
|          | 960           |
|          | 192           |
| <b>W</b> | 40W           |
|          | NO Empalmable |

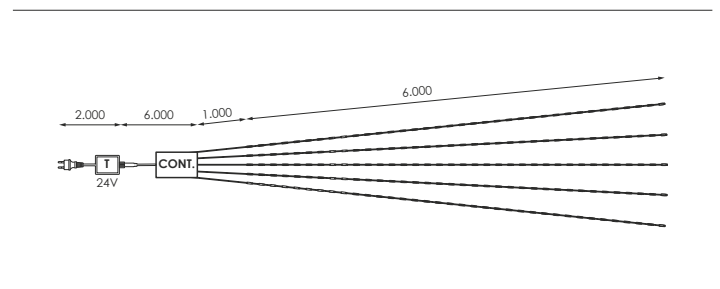

## Información/Information/Information/Informações

Ñ/ Controlador 8 funciones **INCLUIDO.**

E/ Controller 8 functions **IN-CLUDED.**

F/ Contrôleur 8 fonctions **INCLUS.**

P/ Controlador 8 funções **INCLUIDO.**



# Cascada

⚡ 24V

Hz 50-60Hz

⚡ CIII

👁️ 4 CANALES

🌡️ IP44

📊 1,6kg (N.W.)

📦 INC.

📦 6ud (4m)

📦 4ud (7m)

















[GRÁFICOS: Unidades en mm/ GRAPHICS: Units in mm/GRAPHIQUES: Unités en mm/GRÁFICOS: Unidades em mm]





# SCREENLIGHT Cascada

2x1,5m



|   |            |
|---|------------|
|  | 24V        |
|  | 50-60Hz    |
|  | CIII       |
|  | 4 CANALES  |
|  | IP44       |
|  | 3kg (N.W.) |
|  | INC.       |
|  | 2ud        |

|   |   |   |
|---|---|---|
|  |  |  |
| 087094  |  |  |
| 087100  |  |  |

|   |               |
|---|---------------|
|  | 2x1,5m        |
|  | 16            |
|  | 768           |
|  | 48            |
| <b>W</b>  | 35W           |
|  | NO Empalmable |

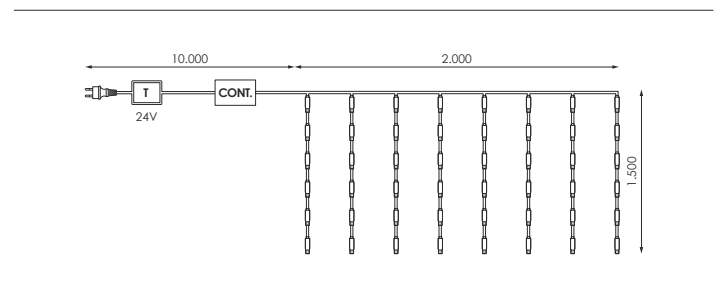

## Información/Information/Information/Informações









Ñ/ Controlador 8 funciones **INCLUIDO.**

E/ Controller 8 functions **IN-CLUDED.**

F/ Contrôleur 8 fonctions **INCLUS.**

P/ Controlador 8 funções **INCLUIDO.**









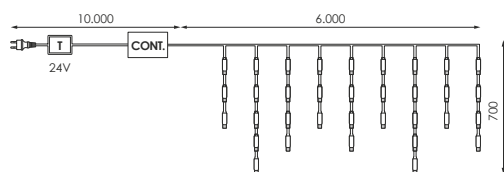
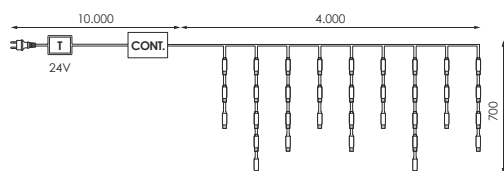



















# ICICLE Cascada

|   |              |
|---|--------------|
|  | 24V          |
| <b>Hz</b>   | 50-60Hz      |
|   | CIII         |
|   | 4 CANALES    |
|   | IP44         |
|   | 1,6kg (N.W.) |
|   | INC.         |
|   | 4ud (4m)     |
|   | 2ud (6m)     |



Santillana del Mar  
Cantabria



|  | 4x0,7m           |  |  |  |
|---|------------------|---|---|---|
|  | 32               | 087155  |  |  |
|  | 576              | 192217  |  |  |
|  | 12/24/16/20      | 087162  |  |  |
| <b>W</b>  | 33W              |   |   |   |
|  | NO<br>Empalmable |   |   |   |
|  | 6x0,7m           |  |  |  |
|  | 48               | 087179  |  |  |
|  | 864              | 192224  |  |  |
|  | 12/24/16/20      | 087186  |  |  |
| <b>W</b>  | 40W              |   |   |   |
|  | NO<br>Empalmable |   |   |   |

## Información/Information/Information/Informações

**Ñ/** Controlador 8 funciones  
**INCLUIDO.**

**E/** Controller 8 functions  
**IN-  
CLUDED.**

**F/** Contrôleur 8 fonctions  
**INCLUS.**

**P/** Controlador 8 funções  
**INCLUIDO.**













Cuidad Real



# Red 24V



## 2x1m Fuente Alimentación





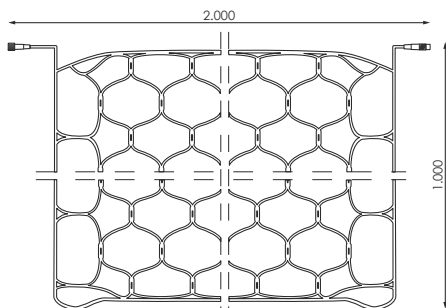

|   |              |
|---|--------------|
|  | 24V dc       |
| <b>Hz</b>   | 50-60Hz      |
|  | CIII         |
|  | 1 CANAL      |
|  | IP65         |
|  | -20°C~+60 °C |
|  | 1,6kg (N.W.) |
|  | NO INC.      |
|  | 10ud         |



Ciudad Real



|   |                       |
|---|-----------------------|
|  | 2x1m                  |
|  | 98                    |
| <b>W</b>  | 5,5W                  |
|  | Máx. 10 sets en serie |

|   |   |   |
|---|---|---|
|  |  |  |
| 163194  |  |  |
| 588898  |  |  |

ESQUEMA INSTALACIÓN/  
INSTALLATION SCHEME/  
SCHEMA D'INSTALLATION/  
ESQUEMA DE  
INSTALAÇÃO



Producto/Product  
Produit/Produto

### Aviso/Warning/Avertissement/Aviso

Ñ/ Uso **OBLIGATORIO** de fuente de alimentación.

E/ You **MUST USE** the power supply.

F/ L'utilisation **OBLIGATOIRE** du l'alimentation

P/ Uso **OBRIGATÓRIO** fonte de alimentação.

Accesorios (NO Incluidos) / Accessoires (NOT Included) / Accessories (NON Inclus)/ Acessórios (NÃO Incluso)

+ INFO PAG. 418

Ñ/ Fuente de alimentación **NO INCLUIDA**

488440

Fuente alimentación 30W 24V

E/ Power supply **NOT INCLUDED**

481687

Fuente alimentación 150W 24V

F/ Alimentation **NON INCLUSE**

488457

Fuente alimentación 60W 24V

571968

Fuente alimentación 200W 24V

488464

Fuente alimentación 100W 24V

P/ Fonte de alimentação **NÃO INCLUIDO**

# Red

2x1m



Guadalupe  
Cáceres

SMART  
LINK

⚡ 230V dc

Hz 50-60Hz

□ CII

⊙ 1 CANAL

⊙ IP65

🌡️ -20°C~+60 °C

📊 1kg (N.W.)

⊗ NO INC.

📦 10ud



| Barcode | Light Type | Beam Angle |
|---------|------------|------------|
| 192231  | LED        | ⊙          |
| 192248  | LED        | ⊙          |
| 192255  | LED        | ⊙          |
| 192262  | LED        | ⊙          |

|    |        |
|----|--------|
| ↕  | 2x1m   |
| 💡  | 200    |
| W  | 18W    |
| ⚙️ | 15sets |

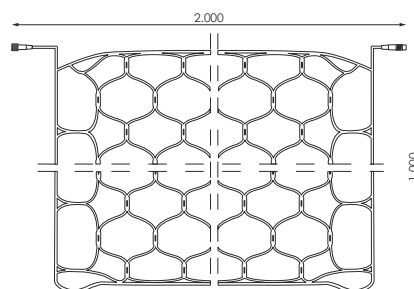

ESQUEMA INSTALACIÓN/  
INSTALLATION SCHEME/  
SCHÉMA D'INSTALLATION/  
ESQUEMA DE  
INSTALAÇÃO



+

Producto/Product  
Produit/Produto

Accesorios (NO Incluidos) / Accessoires (NOT Included) / Accessories (NON Inclus) / Acessórios (NÃO Incluso)

+ INFO PAG. 418

995092

Cable alimentación Negro









977722

Cable alimentación Blanco



# Red 4x2m

SMART  
LINK 

|  |              |
|--|--------------|
|  | 230V dc      |
| <b>Hz</b>  | 50-60Hz      |
|  | CII          |
|  | 1 CANAL      |
|  | IP65         |
|  | -20°C~+60 °C |
|  | 1,3kg (N.W.) |
|  | NO INC.      |
|  | 4ud          |





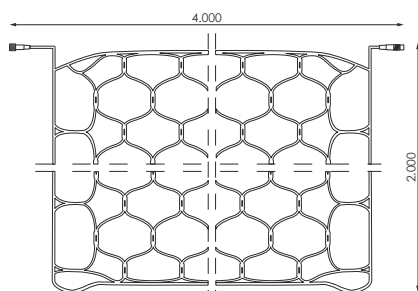











Guadalupe  
Cáceres



ESQUEMA INSTALACIÓN/  
INSTALLATION SCHEME/  
SCHEMA D'INSTALLATION/  
ESQUEMA DE  
INSTALAÇÃO



+ Producto/Product  
Produit/Produto

|   |       |   |   |   |
|---|-------|---|---|---|
|  | 4x2m  |  |  |  |
|  | 400   | 192279  |  |  |
| <b>W</b>  | 30W   | 192286  |  |  |
|  | 7sets | 192293  |  |  |
|   |       | 192309  |  |  |

Accesorios (NO Incluidos) / Accessoires (NOT Included) / Accessories (NON Inclus)/ Acessórios (NÃO Incluso)

+ INFO PAG. 418

995092

Cable alimentación Negro

977722

Cable alimentación Blanco

# Red

## 2x1m Flashing



SMART  
LINK

⚡ 230V dc

Hz 50-60Hz

□ CII

⊙ 1 CANAL

⊙ IP65

🌡 -20°C~+60 °C

📊 1kg (N.W.)

✗ NO INC.

📦 10ud



Cortijo MBI  
Sevilla

|        |  |  |
|--------|--|--|
|        |  |  |
| 386081 |  |  |
| 386098 |  |  |

|   |                    |
|---|--------------------|
|   | 2x1m               |
|   | 170+30<br>flashing |
| W | 18W                |
|   | 15sets             |

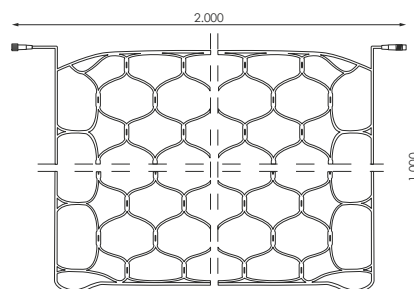

ESQUEMA INSTALACIÓN/  
INSTALLATION SCHEME/  
SCHÉMA D'INSTALLATION/  
ESQUEMA DE  
INSTALAÇÃO



+

Producto/Product  
Produit/Produto

Accesorios (NO Incluidos) / Accessoires (NOT Included) / Accessories (NON Inclus) / Acessórios (NÃO Incluso)

+ INFO PAG. 418

995092

Cable alimentación Negro









977722

Cable alimentación Blanco

# Red

## 4x2m Flashing

SMART  
LINK 

|   |              |
|---|--------------|
|  | 230V dc      |
| <b>Hz</b>   | 50-60Hz      |
|  | CII          |
|  | 1 CANAL      |
|  | IP65         |
|  | -20°C~+60 °C |
|  | 1,3kg (N.W.) |
|  | NO INC.      |
|  | 4ud          |





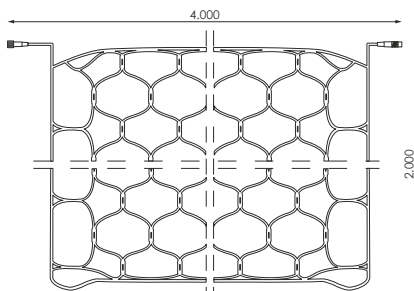







Viveiro  
Lugo



ESQUEMA INSTALACIÓN/  
INSTALLATION SCHEME/  
SCHEMA D'INSTALLATION/  
ESQUEMA DE  
INSTALAÇÃO



Producto/Product  
Produit/Produto

|   |                    |   |   |   |
|---|--------------------|---|---|---|
|  | 4x2m               |  |  |  |
|  | 340+60<br>flashing | 386104  |  |  |
| <b>W</b>  | 30W                | 386111  |  |  |
|  | 7sets              |   |   |   |

Accesorios (NO Incluidos) / Accessoires (NOT Included) / Accessories (NON Inclus) / Acessórios (NÃO Incluso)

+ INFO PAG. 418

995092

Cable alimentación Negro

977722

Cable alimentación Blanco







# Accesorios (NO Incluidos)

Accessoires (NOT Included)

Accessories (NON Inclus)

Acessórios (NÃO Incluso)

|  |  | String AVANT 180 IP67 / String AVANT 180 IP67 Flashing | STRING PLUS 180 24V / STRING PLUS 180 24V Flashing | STRING PLUS 180 / STRING PLUS 180 Flashing | STRING PLUS 120 All Flashing | STRING PLUS 180 Sparkles | STRING PLUS 180 Dual | SCREENLIGHT 300 24V | SCREENLIGHT 600 24V | SCREENLIGHT / SCREENLIGHT Flashing | SCREENLIGHT All Flashing | SCREENLIGHT Dual | SCREENLIGHT 250 FALL LITE | Cluster Light Fall Lite | Cluster Light Flashing | Techo Luz SCREENLIGHT Flashing | ICICLE# / ICICLE# Flashing | Red 24V | Red / Red Flashing |
|--|---|--|--|--|------------------------------|--------------------------|----------------------|---------------------|---------------------|------------------------------------|--------------------------|------------------|---------------------------|-------------------------|------------------------|--------------------------------|----------------------------|---------|--------------------|
|  | 149181  |  | •  |  |                              |                          |                      |                     |                     |                                    |                          |                  |                           |                         |                        |                                |                            | •       |                    |
|  | 149198  |  | •  |  |                              |                          |                      |                     |                     |                                    |                          |                  |                           |                         |                        |                                |                            | •       |                    |
|  | 149204  |  | •  |  |                              |                          |                      | •                   |                     |                                    |                          |                  |                           |                         |                        |                                |                            | •       |                    |
|  | 149211  |  | •  |  |                              |                          |                      | •                   |                     |                                    |                          |                  |                           |                         |                        |                                |                            | •       |                    |
|  | 150323  |  | •  |  |                              |                          |                      | •                   |                     |                                    |                          |                  |                           |                         |                        |                                |                            | •       |                    |
|  | 192507  |  |  |  |                              |                          |                      |                     |                     | •                                  | •                        |                  |                           |                         | •                      | •                              | •                          |         | •                  |
|  | 192514  |  |  |  |                              |                          |                      |                     |                     | •                                  | •                        |                  |                           |                         | •                      | •                              | •                          |         | •                  |
|  | 193061  |  |  |  |                              |                          |                      |                     |                     |                                    |                          |                  | •                         | •                       |                        |                                |                            |         |                    |
|  | 193078  |  |  |  |                              |                          |                      |                     |                     |                                    |                          |                  | •                         | •                       |                        |                                |                            |         |                    |
|  | 364478  |  | •  |  |                              |                          |                      |                     | •                   |                                    |                          |                  |                           |                         |                        |                                |                            | •       |                    |
|  | 481687  |  | •  |  |                              |                          |                      | •                   |                     |                                    |                          |                  |                           |                         |                        |                                |                            | •       |                    |
|  | 487207  | •  |  |  |                              |                          |                      |                     |                     |                                    |                          |                  |                           |                         |                        |                                |                            |         |                    |
|  | 487214  | •  |  |  |                              |                          |                      |                     |                     |                                    |                          |                  |                           |                         |                        |                                |                            |         |                    |
|  | 487474  | •  |  |  |                              |                          |                      |                     |                     |                                    |                          |                  |                           |                         |                        |                                |                            |         |                    |
|  | 488440  |  | •  |  |                              |                          |                      | •                   |                     |                                    |                          |                  |                           |                         |                        |                                |                            | •       |                    |
|  | 488457  |  | •  |  |                              |                          |                      | •                   |                     |                                    |                          |                  |                           |                         |                        |                                |                            | •       |                    |
|  | 488464  |  | •  |  |                              |                          |                      | •                   |                     |                                    |                          |                  |                           |                         |                        |                                |                            | •       |                    |
|  | 571968  |  | •  |  |                              |                          |                      | •                   |                     |                                    |                          |                  |                           |                         |                        |                                |                            | •       |                    |
|  | 977722  |  |  | •  | •                            | •                        |                      |                     |                     | •                                  | •                        |                  |                           |                         | •                      | •                              | •                          |         | •                  |
|  | 995092  |  |  | •  | •                            | •                        |                      |                     |                     | •                                  | •                        |                  |                           |                         | •                      | •                              | •                          |         | •                  |
|  | 391559  |  |  |  |                              |                          | •                    |                     |                     |                                    |                          | •                |                           |                         |                        |                                |                            |         |                    |
|  | 971072  |  |  |  |                              |                          | •                    |                     |                     |                                    |                          | •                |                           |                         |                        |                                |                            |         |                    |
|  | 192323  |  |  | •  | •                            | •                        |                      |                     |                     | •                                  | •                        |                  | •                         | •                       | •                      | •                              | •                          |         | •                  |
|  | 192347  |  |  | •  | •                            | •                        |                      |                     |                     | •                                  | •                        |                  | •                         | •                       | •                      | •                              | •                          |         | •                  |
|  | 192354  |  |  | •  | •                            | •                        |                      |                     |                     | •                                  | •                        |                  | •                         | •                       | •                      | •                              | •                          |         | •                  |
|  | 192361  |  |  | •  | •                            | •                        |                      |                     |                     | •                                  | •                        |                  | •                         | •                       | •                      | •                              | •                          |         | •                  |
|  | 192378  |  |  | •  | •                            | •                        |                      |                     |                     | •                                  | •                        |                  | •                         | •                       | •                      | •                              | •                          |         | •                  |
|  | 192385  |  |  | •  | •                            | •                        |                      |                     |                     | •                                  | •                        |                  | •                         | •                       | •                      | •                              | •                          |         | •                  |
|  | 192392  |  |  | •  | •                            | •                        |                      |                     |                     | •                                  | •                        |                  | •                         | •                       | •                      | •                              | •                          |         | •                  |
|  | 192408  |  |  | •  | •                            | •                        |                      |                     |                     | •                                  | •                        |                  | •                         | •                       | •                      | •                              | •                          |         | •                  |
|  | 192415  |  |  | •  | •                            | •                        |                      |                     |                     | •                                  | •                        |                  | •                         | •                       | •                      | •                              | •                          |         | •                  |
|  | 192422  |  |  | •  | •                            | •                        |                      |                     |                     | •                                  | •                        |                  | •                         | •                       | •                      | •                              | •                          |         | •                  |
|  | 192439  |  |  | •  | •                            | •                        |                      |                     |                     | •                                  | •                        |                  | •                         | •                       | •                      | •                              | •                          |         | •                  |
|  | 192446  |  |  | •  | •                            | •                        |                      |                     |                     | •                                  | •                        |                  | •                         | •                       | •                      | •                              | •                          |         | •                  |
|  | 192453  |  |  | •  | •                            | •                        |                      |                     |                     | •                                  | •                        |                  | •                         | •                       | •                      | •                              | •                          |         | •                  |
|  | 192477  |  |  | •  | •                            | •                        |                      |                     |                     | •                                  | •                        |                  | •                         | •                       | •                      | •                              | •                          |         | •                  |
|  | 192484  |  |  | •  | •                            | •                        |                      |                     |                     | •                                  | •                        |                  | •                         | •                       | •                      | •                              | •                          |         | •                  |

|   |  | String AVANT 180 IP67 / String AVANT 180 IP67 Flashing | STRING PLUS 180 24V / STRING PLUS 180 24V Flashing | STRING PLUS 180 / STRING PLUS 180 Flashing | STRING PLUS 120 All Flashing | STRING PLUS 180 Sparkles | STRING PLUS 180 Dual | SCREENLIGHT 300 24V | SCREENLIGHT 600 24V | SCREENLIGHT 250 / SCREENLIGHT 250 Flashing | SCREENLIGHT All Flashing | SCREENLIGHT Dual | SCREENLIGHT 250 FALL LITE | Cluster Light Fall Lite | Cluster Light Flashing | Techo Luz SCREENLIGHT Flashing | ICICLE / ICICLE Flashing | Red 24V | Red / Red Flashing |
|---|---|--|--|--|------------------------------|--------------------------|----------------------|---------------------|---------------------|--|--------------------------|------------------|---------------------------|-------------------------|------------------------|--------------------------------|--------------------------|---------|--------------------|
| 192491  |   |  |  | •  | •                            | •                        |                      |                     |                     | •  | •                        |                  | •                         | •                       | •                      | •                              | •                        |         | •                  |
| 388368  |   |  |  | •  | •                            | •                        |                      |                     |                     | •  | •                        |                  | •                         | •                       | •                      | •                              | •                        |         | •                  |
| 388375  |   |  |  | •  | •                            | •                        |                      |                     |                     | •  | •                        |                  | •                         | •                       | •                      | •                              | •                        |         | •                  |
| 388382  |   |  |  | •  | •                            | •                        |                      |                     |                     | •  | •                        |                  | •                         | •                       | •                      | •                              | •                        |         | •                  |
| 388399  |   |  |  | •  | •                            | •                        |                      |                     |                     | •  | •                        |                  | •                         | •                       | •                      | •                              | •                        |         | •                  |
| 388498  |   |  |  | •  | •                            | •                        |                      |                     |                     | •  | •                        |                  | •                         | •                       | •                      | •                              | •                        |         | •                  |
| 388504  |   |  |  | •  | •                            | •                        |                      |                     |                     | •  | •                        |                  | •                         | •                       | •                      | •                              | •                        |         | •                  |
| 391498  |   |  |  | •  | •                            | •                        |                      |                     |                     | •  | •                        |                  | •                         | •                       | •                      | •                              | •                        |         | •                  |
| 391504  |   |  |  | •  | •                            | •                        |                      |                     |                     | •  | •                        |                  | •                         | •                       | •                      | •                              | •                        |         | •                  |
| 391535  |   |  | •  |  |                              |                          | •                    | •                   | •                   |  |                          | •                |                           |                         |                        |                                |                          | •       |                    |
| 481700  |   |  | •  |  |                              |                          | •                    | •                   | •                   |  |                          | •                |                           |                         |                        |                                |                          | •       |                    |
| 481717  |   |  | •  |  |                              |                          | •                    | •                   | •                   |  |                          | •                |                           |                         |                        |                                |                          | •       |                    |
| 481724  |   |  | •  |  |                              |                          | •                    | •                   | •                   |  |                          | •                |                           |                         |                        |                                |                          | •       |                    |
| 487221  | •   |  |  |  |                              |                          |                      |                     |                     |  |                          |                  |                           |                         |                        |                                |                          |         |                    |
| 487238  | •   |  |  |  |                              |                          |                      |                     |                     |  |                          |                  |                           |                         |                        |                                |                          |         |                    |
| 487245  | •   |  |  |  |                              |                          |                      |                     |                     |  |                          |                  |                           |                         |                        |                                |                          |         |                    |
| 487252  | •   |  |  |  |                              |                          |                      |                     |                     |  |                          |                  |                           |                         |                        |                                |                          |         |                    |
| 487269  | •   |  |  |  |                              |                          |                      |                     |                     |  |                          |                  |                           |                         |                        |                                |                          |         |                    |
|  487276 | •   |  |  |  |                              |                          |                      |                     |                     |  |                          |                  |                           |                         |                        |                                |                          |         |                    |
| 487283  | •   |  |  |  |                              |                          |                      |                     |                     |  |                          |                  |                           |                         |                        |                                |                          |         |                    |
| 487344  | •   |  |  |  |                              |                          |                      |                     |                     |  |                          |                  |                           |                         |                        |                                |                          |         |                    |
| 487375  | •   |  |  |  |                              |                          |                      |                     |                     |  |                          |                  |                           |                         |                        |                                |                          |         |                    |
| 487382  | •   |  |  |  |                              |                          |                      |                     |                     |  |                          |                  |                           |                         |                        |                                |                          |         |                    |
| 487399  | •   |  |  |  |                              |                          |                      |                     |                     |  |                          |                  |                           |                         |                        |                                |                          |         |                    |
| 487405  | •   |  |  |  |                              |                          |                      |                     |                     |  |                          |                  |                           |                         |                        |                                |                          |         |                    |
| 487412  | •   |  |  |  |                              |                          |                      |                     |                     |  |                          |                  |                           |                         |                        |                                |                          |         |                    |
| 487429  | •   |  |  |  |                              |                          |                      |                     |                     |  |                          |                  |                           |                         |                        |                                |                          |         |                    |
| 487436  | •   |  |  |  |                              |                          |                      |                     |                     |  |                          |                  |                           |                         |                        |                                |                          |         |                    |
| 487443  | •   |  |  |  |                              |                          |                      |                     |                     |  |                          |                  |                           |                         |                        |                                |                          |         |                    |
| 487450  | •   |  |  |  |                              |                          |                      |                     |                     |  |                          |                  |                           |                         |                        |                                |                          |         |                    |
| 487467  | •   |  |  |  |                              |                          |                      |                     |                     |  |                          |                  |                           |                         |                        |                                |                          |         |                    |
| 553698  | •   | •  | •  | •  | •                            | •                        | •                    | •                   | •                   | •  | •                        | •                | •                         | •                       | •                      | •                              | •                        | •       | •                  |
| 971140  |   |  | •  |  |                              |                          | •                    | •                   | •                   |  |                          | •                |                           |                         |                        |                                |                          | •       | •                  |
| 971188  |   |  | •  |  |                              |                          | •                    | •                   | •                   |  |                          | •                |                           |                         |                        |                                |                          | •       | •                  |
| 971195  |   |  | •  |  |                              |                          | •                    | •                   | •                   |  |                          | •                |                           |                         |                        |                                |                          | •       | •                  |
| 971201  |   |  | •  |  |                              |                          | •                    | •                   | •                   |  |                          | •                |                           |                         |                        |                                |                          | •       | •                  |
| 971218  |   |  | •  |  |                              |                          | •                    | •                   | •                   |  |                          | •                |                           |                         |                        |                                |                          | •       | •                  |
|  400794 |   |  |  | •  | •                            | •                        |                      |                     |                     | •  | •                        |                  | •                         | •                       | •                      | •                              | •                        |         | •                  |

### CABLE ALIMENTACIÓN AVANT

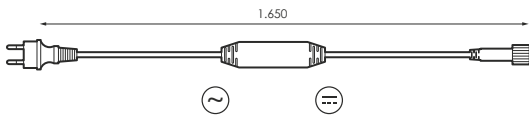

|        |  |        |           |     |                            |  |
|--------|--|--------|-----------|-----|----------------------------|--|
|        |  |        |           |     |                            |  |
| 487207 |  | 230Vac | Max. 480W | CII | IP44 Plug<br>IP67 Conector |  |
| 487214 |  | 230Vac | Max. 480W | CII | IP44 Plug<br>IP67 Conector |  |

### RECTIFICADOR AVANT

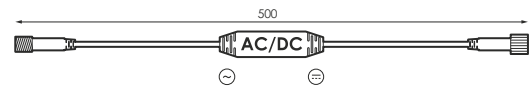

|        |  |           |     |      |  |
|--------|--|-----------|-----|------|--|
|        |  |           |     |      |  |
| 487481 |  | Max. 460W | CII | IP67 |  |
| 487474 |  | Max. 460W | CII | IP67 |  |

### ADAPTADOR AVANT

#### SMART-FLEXILIGHT

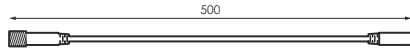

|        |  |      |  |
|--------|--|------|--|
|        |  |      |  |
| 487443 |  | IP67 |  |
| 487436 |  | IP67 |  |

Termoretractil y conector macho **NO INCLUIDOS**  
Heat-shrinkable and male connector **NOT INCLUDED**  
Thermorétractable et connecteur mâle **NON INCLUS**  
Tubo de contração térmica e conector macho **NÃO INCLUÍDO**

### ADAPTADOR AVANT

#### FLEXILIGHT-SMART

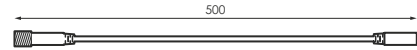

|        |  |      |  |
|--------|--|------|--|
|        |  |      |  |
| 487467 |  | IP67 |  |
| 487450 |  | IP67 |  |

Termoretractil y conector macho **NO INCLUIDOS**  
Heat-shrinkable and male connector **NOT INCLUDED**  
Thermorétractable et connecteur mâle **NON INCLUS**  
Tubo de contração térmica e conector macho **NÃO INCLUÍDO**

### EXTENSIÓN AVANT

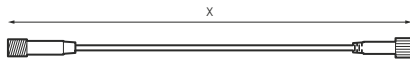

|        |    |  |      |
|--------|----|--|------|
|        |    |  |      |
| 487238 | 1m |  | IP67 |
| 487221 | 1m |  | IP67 |
| 487252 | 3m |  | IP67 |
| 487245 | 3m |  | IP67 |
| 487276 | 5m |  | IP67 |
| 487269 | 5m |  | IP67 |

### CONECTOR 5 AVANT

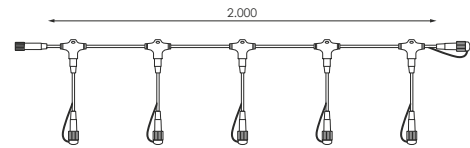

|        |    |   |  |      |
|--------|----|---|--|------|
|        |    |   |  |      |
| 487382 | 2m | 5 |  | IP67 |
| 487375 | 2m | 5 |  | IP67 |

### CONECTOR 10 AVANT

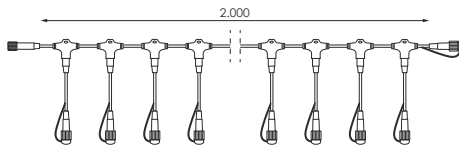

|        |    |    |  |      |
|--------|----|----|--|------|
|        |    |    |  |      |
| 487405 | 2m | 10 |  | IP67 |
| 487399 | 2m | 10 |  | IP67 |

### CONECTOR 10 AVANT

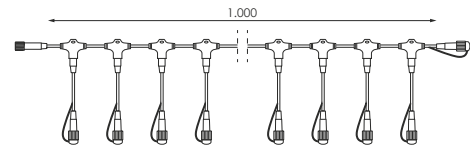

|        |    |    |  |      |
|--------|----|----|--|------|
|        |    |    |  |      |
| 487344 | 1m | 10 |  | IP67 |
| 487283 | 1m | 10 |  | IP67 |



CONECTOR T AVANT

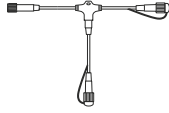

487429



IP67

487412



IP67

TRANSFORMADOR 24V

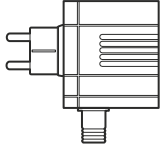

W

149181

Máx. 10,8W

Sin rectificador  
Without rectifier  
Sans redresseur  
Sem retificador

TRANSFORMADOR 24V

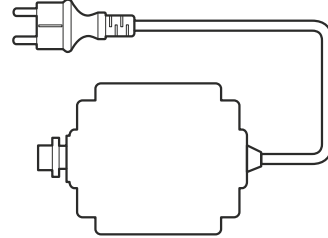

W

149198

Máx. 28,8W

Sin rectificador  
Without rectifier  
Sans redresseur  
Sem retificador

TRANSFORMADOR 24V

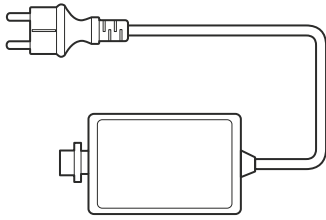

W

149204

Max. 60W

Sin rectificador  
Without rectifier  
Sans redresseur  
Sem retificador

TRANSFORMADOR 24V

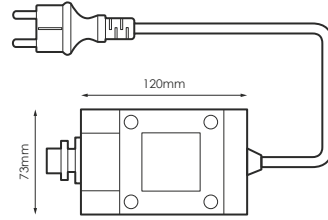

W

149211

Max. 120W

Sin rectificador  
Without rectifier  
Sans redresseur  
Sem retificador

RECTIFICADOR 24V

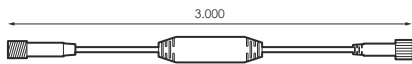

W

150323

3m

Max. 60W

364478

3m

Max. 90W

FUENTE ALIMENTACIÓN 24V

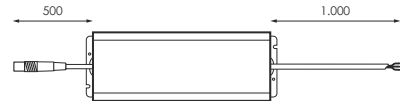

488440 170-240V 24V 30W IP66/ IP44 Plug 202 x 34 x 36mm 1 salida

488457 170-240V 24V 60W IP66/ IP44 Plug 197 x 45 x 32mm 1 salida

488464 170-240V 24V 100W IP66/ IP44 Plug 248 x 45 x 32mm 1 salida

481687 100-240V 24V 150W IP66/ IP44 Plug 230 x 63 x 39mm 1 salida

571968 100-240V 24V 200W IP66/ IP44 Plug 260 x 73 x 45mm 2 salidas

CABLE ALIMENTACIÓN SMART LINK

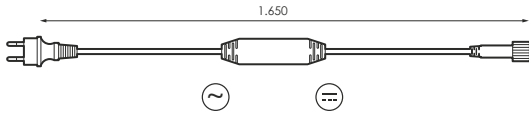

|    |        |        |           |     |                            |
|----|--------|--------|-----------|-----|----------------------------|
| UR | 995092 | 230Vac | Max. 480W | CII | IP44 Plug<br>IP65 Conector |
|    | 977722 | 230Vac | Max. 480W | CII | IP44 Plug<br>IP65 Conector |

CABLE ALIMENTACIÓN SMART LINK

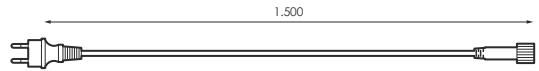

|    |        |        |           |     |                            |
|----|--------|--------|-----------|-----|----------------------------|
| UR | 193061 | 230Vac | Max. 480W | CII | IP44 Plug<br>IP65 Conector |
|    | 193078 | 230Vac | Max. 480W | CII | IP44 Plug<br>IP65 Conector |

RECTIFICADOR SMART LINK

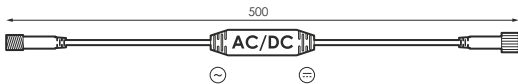

|   |        |           |     |      |
|---|--------|-----------|-----|------|
| R | 192514 | Max. 460W | CII | IP65 |
|   | 192507 | Max. 460W | CII | IP65 |

TAPA FINAL SMART LINK



|        |    |        |
|--------|----|--------|
| 400794 | BI | Blanco |
|--------|----|--------|

EXTENSIÓN SMART LINK

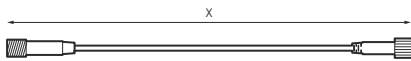

|        |      |      |  |
|--------|------|------|--|
|        | ↔    |      |  |
| 388498 | 0,5m | IP65 |  |
| 388504 | 0,5m | IP65 |  |
| 192347 | 1m   | IP65 |  |
| 192323 | 1m   | IP65 |  |
| 192361 | 3m   | IP65 |  |
| 192354 | 3m   | IP65 |  |
| 192385 | 5m   | IP65 |  |
| 192378 | 5m   | IP65 |  |

TERMORRETRACTIL

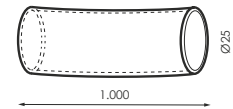

|        |   |
|--------|---|
| 553698 | Termoretractil Ø25mm, corte 1m.<br>Heat-shrinkable Ø25mm, cut 1m.<br>Ø25mm thermorétractable, couper 1m.<br>Tubo contração termica Ø25mm, corte 1m. |
|--------|---|

ADAPTADOR SMART LINK

SMART-FLEXILIGHT

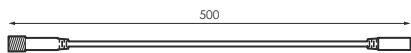

|   |        |      |
|---|--------|------|
| A | 192477 | IP65 |
|   | 192453 | IP65 |

ADAPTADOR SMART LINK

FLEXILIGHT-SMART

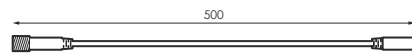

|   |        |      |
|---|--------|------|
| A | 192491 | IP65 |
|   | 192484 | IP65 |

Termoretractil y conector macho **NO INCLUIDOS**  
Heat-shrinkable and male connector **NOT INCLUDED**  
Thermorétractable et connecteur mâle **NON INCLUS**  
Tubo de contração térmica e conector macho **NÃO INCLuíDO**

Termoretractil y conector macho **NO INCLUIDOS**  
Heat-shrinkable and male connector **NOT INCLUDED**  
Thermorétractable et connecteur mâle **NON INCLUS**  
Tubo de contração térmica e conector macho **NÃO INCLuíDO**

CONECTOR T SMART LINK

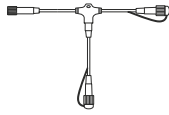

192446



IP65

192439



IP65

CONECTOR X SMART LINK

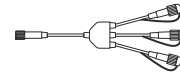

391504



IP65

391498



IP65

CONECTOR 5 SMART LINK

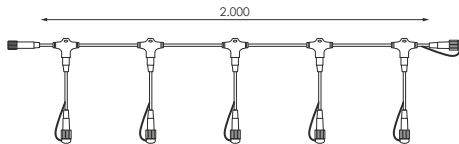

388375

2m

5



IP65

388368

2m

5



IP65

CONECTOR 10 SMART LINK

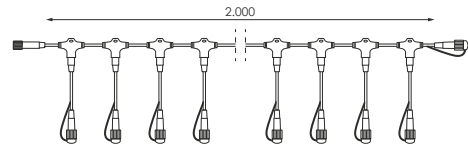

388399

2m

10



IP65

388382

2m

10



IP65

CONECTOR 10 SMART LINK

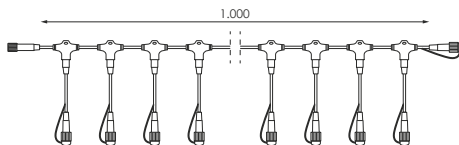

192408

1m

10



IP65

192392

1m

10



IP65

CONECTOR 20 SMART LINK

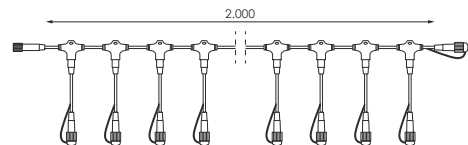

192422

2m

20



IP65

192415

2m

20



IP65



CONTROLADOR DUAL

2A

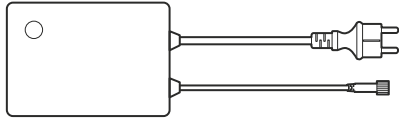

391559



230V

W

Max. 240W

8 funciones efecto memoria  
8 functions memory effect  
8 fonctions effet mémoire  
8 funções efeito de memória

CONTROLADOR DUAL

6A

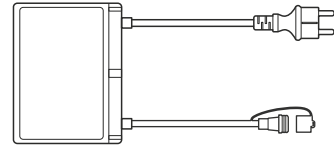

971072



230V

W

Max. 1.200W



\*Max. 240m

\*Máx. 240m (máx. 90m por salida)/ 4 funciones  
\*Max. 240m (max. 90m per output)/ 4 functions  
\*Max. 240m (max. 90m par sortie)/ 4 fonctions  
\*Max. 240m (max. 90m por saída)/ 4 funções

EXTENSIÓN DUAL/24V

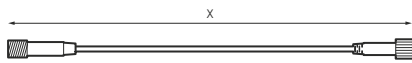

391535

0,5m



481724

1m



971188

3m



971140

5m



588911

0,5m



588928

1m



588935

3m



588942

5m



CONECTOR DUAL/24V

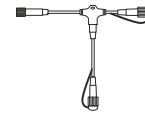

971218

Conector T  
Connector T  
Connecteur en T  
Conector em T

CONECTOR 10 DUAL/24V

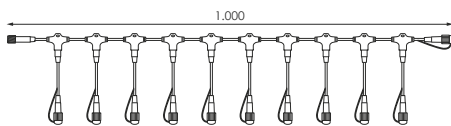

971195

1m

10

CONECTOR 5 DUAL/24V

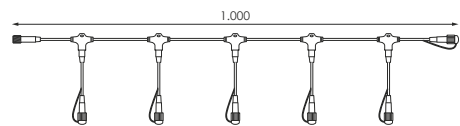

971201

1m

5

CONECTOR 10 DUAL/24V

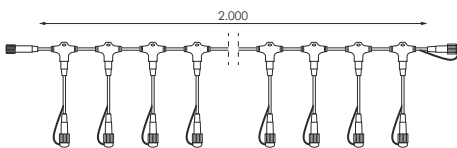

481700

2m

10



IP44

CONECTOR 20 DUAL/24V

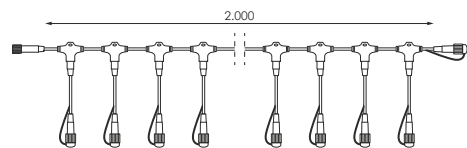

481717

2m

20



IP44









# Led Interior

Indoors Led  
Led à l'intérieur  
Led Interior























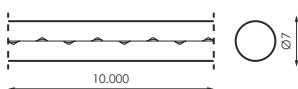









# flexiLIGHT LED

Ø7mm

|   |                 |
|---|-----------------|
|  | 6V              |
| <b>Hz</b>   | 50-60Hz         |
|  | CIII            |
|  | 1 CANAL/ 2 VÍAS |
|  | IP44            |
|  | 360°            |
|  | -20°C~+60 °C    |
|  | INC.            |
|  | Rollo 10m       |

**Ñ/** \*Con movimiento.  
**E/** \*With movement.  
**F/** \*Avec mouvement.  
**P/** \*Com movimento.



|   |                  |   |   |   |
|---|------------------|---|---|---|
|  | 7mm              |  |  |  |
|  | 20               | 192521  |  |  |
| <b>W</b>  | 6W               | 192538  |  |  |
|  | NO<br>Empalmable | 192545  |  |  |
|  | Rollo 10m        | 192552  |  |  |
|   |                  | 192569*   |  |  |

Aviso/Warning/Avertissement/Aviso

Ñ/ Transformador **INCLUIDO.**

E/ Transformer **INCLUDED.**

F/ Transformateur **INCLUS.**

P/ Transformador **INCLUÍDO.**



# STRING PLUS 180



SMART LINK 

 230V dc

Hz 50-60Hz

 CII

 1 CANAL

 IP20













 -20°C~+60 °C







 0,9kg (N.W.)

 NO INC.

 10ud



|   |   |   |
|---|---|---|
|  |  |  |
| 192576  |  |  |
| 192583  |  |  |
| 405874  |  |  |
| 405850  |  |  |
| 405867  |  |  |

|   |                    |
|---|--------------------|
|  | 12m<br>(4m x 3seg) |
|  | 4m                 |
|  | 180                |
|  | 60                 |
| W   | 10W                |
|  | 3,5W               |
|  | 100m               |

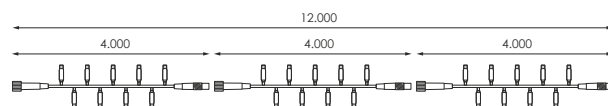

ESQUEMA INSTALACIÓN/  
INSTALLATION SCHEME/  
SCHÉMA D'INSTALLATION/  
ESQUEMA DE  
INSTALAÇÃO



+

Producto/Product  
Produit/Produto

Accesorios (NO Incluidos) / Accessoires (NOT Included) / Accessories (NON Inclus) / Acessórios (NÃO Incluso)









+ INFO PAG. 438

192606

Cable alimentación Transparente

# STRING **PLUS** 180

## Flashing

|   |               |
|---|---------------|
|  | 230V dc       |
| <b>Hz</b>   | 50-60Hz       |
|  | CII           |
|  | 1 CANAL       |
|  | IP20          |
|  | -20°C~+60 °C  |
|  | 1,15kg (N.W.) |
|  | NO INC.       |
|  | 10ud          |





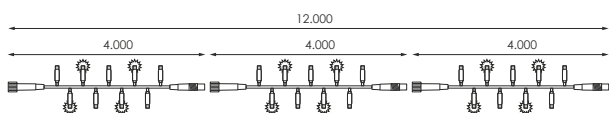



CC. Nervión Plaza  
Sevilla











ESQUEMA INSTALACIÓN/  
INSTALLATION SCHEME/  
SCHEMA D'INSTALLATION/  
ESQUEMA DE  
INSTALAÇÃO



Producto/Product  
Produit/Produto

|   |                    |
|---|--------------------|
|  | 12m<br>(4m x 3seg) |
|  | 4m                 |
|  | 180                |
|  | 50+10<br>flashing  |
| <b>W</b>  | 10W                |
|  | 3,5W               |
|  | 100m               |

|   |   |   |
|---|---|---|
|  |    |  |
| 413756  |   |  |
| 413763  |   |  |

Accesorios (NO Incluidos) / Accessoires (NOT Included) / Accessories (NON Inclus) / Acessórios (NÃO Incluso)

+ INFO PAG. 438

192606

Cable alimentación Transparente

# Cluster Light

## Fall Lite 3m



|           |              |
|-----------|--------------|
|           | 230V         |
| <b>Hz</b> | 50-60Hz      |
|           | CII          |
|           | IP20         |
|           | -20°C~+60 °C |
|           | 1,4kg (N.W.) |
|           | NO INC.      |
|           | INC.         |
|           | 10ud         |



|        |  |  |          |               |
|--------|--|--|----------|---------------|
|        |  |  |          | 3m            |
| 388269 |  |  |          | 6cm           |
| 388276 |  |  |          | 150           |
|        |  |  | <b>W</b> | 3,5W          |
|        |  |  |          | NO Empalmable |

ESQUEMA INSTALACIÓN/  
INSTALLATION SCHEME/  
SCHEMA D'INSTALLATION/  
ESQUEMA DE  
INSTALAÇÃO

+ Producto/Product  
Produit/Produto

Accesorios (NO Incluidos) / Accessoires (NOT Included) / Accessories (NON Inclus) / Acessórios (NÃO Incluso)

+ INFO PAG. 438

193061  
Cable alimentación Negro

193078  
Cable alimentación Blanco



# Cluster Light

## Fall Lite 5m

SMART  
LINK 

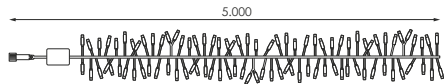









ESQUEMA INSTALACIÓN/  
INSTALLATION SCHEME/  
SCHEMA D'INSTALLATION/  
ESQUEMA DE  
INSTALAÇÃO



+

Producto/Product  
Produit/Produto

|   |                  |
|---|------------------|
|  | 5m               |
|  | 6cm              |
|  | 250              |
| W   | 7W               |
|  | NO<br>Empalmable |

|   |   |   |
|---|---|---|
|  |  |  |
| 388290  |  |  |

Accesorios (NO Incluidos) / Accessoires (NOT Included) / Accessories (NON Inclus)/ Acessórios (NÃO Incluso)

+ INFO PAG. 438

193061

Cable alimentación Negro

193078

Cable alimentación Blanco

# Cluster Light

## Fall Lite 10m

SMART  
LINK 

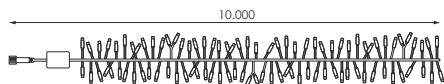











ESQUEMA INSTALACIÓN/  
INSTALLATION SCHEME/  
SCHEMA D'INSTALLATION/  
ESQUEMA DE  
INSTALAÇÃO



+

Producto/Product  
Produit/Produto

|   |                  |
|---|------------------|
|  | 10m              |
|  | 6cm              |
|  | 500              |
| W   | 12W              |
|  | NO<br>Empalmable |

|   |   |   |
|---|---|---|
|  |  |  |
| 388306  |  |  |
| 388313  |  |  |

Accesorios (NO Incluidos) / Accessoires (NOT Included) / Accessories (NON Inclus)/ Acessórios (NÃO Incluso)

+ INFO PAG. 438

193061

Cable alimentación Negro

193078

Cable alimentación Blanco

# SCREENLIGHT 300

Flashing



SMART LINK 

 230V dc

Hz 50-60Hz

 CII

 1 CANAL

 IP20

 -20°C~+60 °C











 3kg (N.W.)





 NO INC.

 5ud



Perequera  
Alicante

|   |   |   |
|---|---|---|
|  |    |  |
| 388320  |     |   |
| 388337  |     |   |

|   |                           |
|---|---------------------------|
|  | 2x1,5m                    |
|  | 20<br>(2 tiras = 1 serie) |
|  | 300                       |
|  | 13+2<br>flashing          |
| W   | 31W                       |
|  | 10sets                    |

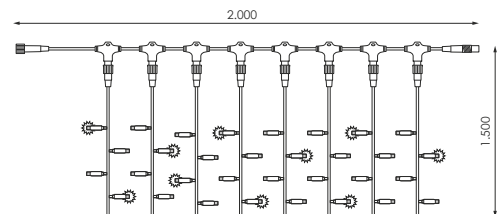

ESQUEMA INSTALACIÓN/  
INSTALLATION SCHEME/  
SCHEMA D'INSTALLATION/  
ESQUEMA DE  
INSTALAÇÃO



+

Producto/Product  
Produit/Produto

Accesorios (NO Incluidos) / Accessoires (NOT Included) / Accessories (NON Inclus) / Acessórios (NÃO Includo)









+ INFO PAG. 438

192606

Cable alimentación Transparente

# SCREENLIGHT 600

Flashing



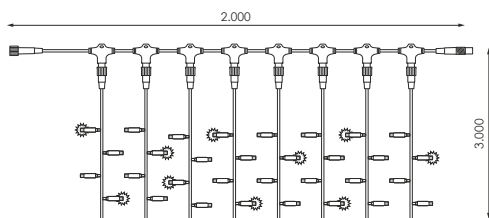

|  |              |
|--|--------------|
|  | 230V dc      |
| <b>Hz</b>  | 50-60Hz      |
|  | CII          |
|  | 1 CANAL      |
|  | IP20         |
|  | -20°C~+60 °C |
|  | 4,7kg (N.W.) |
|  | NO INC.      |
|  | 2ud          |









ESQUEMA INSTALACIÓN/  
INSTALLATION SCHEME/  
SCHEMA D'INSTALLATION/  
ESQUEMA DE  
INSTALAÇÃO



+ Producto/Product  
Produit/Produto

|   |                           |
|---|---------------------------|
|  | 2x3m                      |
|  | 20<br>(2 tiras = 1 serie) |
|  | 600                       |
|  | 26+4<br>flashing          |
| <b>W</b>  | 38,5W                     |
|  | 7sets                     |

|   |   |   |
|---|---|---|
|  |  |  |
| 441674  |  |  |
| 441681  |  |  |

Accesorios (NO Incluidos) / Accessoires (NOT Included) / Accessories (NON Inclus)/ Acessórios (NÃO Incluso)

+ INFO PAG. 438

192606

Cable alimentación Transparente



# ICICLE<sup>®</sup> 114



SMART  
LINK

⚡ 230V dc

Hz 50-60Hz

☐ CII

☺ 1 CANAL

°° IP20

🌡️ -20°C~+60 °C

📊 1kg (N.W.)

✖ NO INC.

📦 10ud



CC. El Saler  
Valencia

|        |  |  |
|--------|--|--|
|        |  |  |
| 192637 |  |  |
| 546553 |  |  |
| 546560 |  |  |

|          |                         |
|----------|-------------------------|
|          | 3x0,5m<br>(1,5m x 2seg) |
|          | Nº 2                    |
|          | 114                     |
|          | 57                      |
| <b>W</b> | 8,2W                    |
|          | 20sets                  |

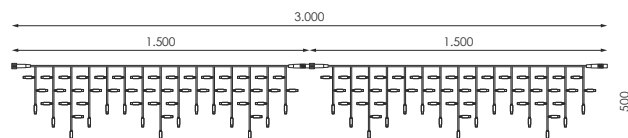

ESQUEMA INSTALACIÓN/  
INSTALLATION SCHEME/  
SCHEMA D'INSTALLATION/  
ESQUEMA DE  
INSTALAÇÃO



+









Producto/Product  
Produit/Produto

Accesorios (NO Incluidos) / Accessoires (NOT Included) / Accessories (NON Inclus) / Acessórios (NÃO Incluso)

+ INFO PAG. 438

192606

Cable alimentación Transparente

|   |              |
|---|--------------|
|  | 230V dc      |
| <b>Hz</b>   | 50-60Hz      |
|  | CII          |
|  | 1 CANAL      |
|  | IP20         |
|  | -20°C~+60 °C |
|  | 1,7kg (N.W.) |
|  | NO INC.      |
|  | 10ud         |



SMART LINK 

CC. Arturo Soria  
Madrid

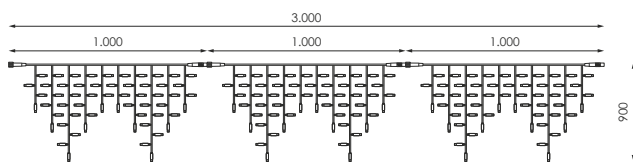













ESQUEMA INSTALACIÓN/  
INSTALLATION SCHEME/  
SCHEMA D'INSTALLATION/  
ESQUEMA DE  
INSTALAÇÃO



+

Producto/Product  
Produit/Produto

|   |                       |
|---|-----------------------|
|  | 3x0,9m<br>(1m x 3seg) |
|  | 3                     |
|  | 174                   |
|  | 58                    |
| <b>W</b>  | 11,6W                 |
|  | 15sets                |

|   |   |   |
|---|---|---|
|  |  |  |
| 192644  |  |  |
| 192651  |  |  |

Accesorios (NO Incluidos) / Accessoires (NOT Included) / Accessories (NON Inclus) / Acessórios (NÃO Incluso)

+ INFO PAG. 438

192606



Cable alimentación Transparente

# Accesorios (NO Incluidos)

Accessoires (NOT Included)

Accessories (NON Inclus)

Acessórios (NÃO Incluso)





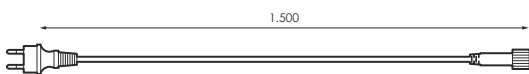

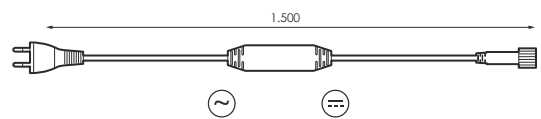

|    |        | STRING <b>PLUS</b><br>180 | STRING <b>PLUS</b><br>180 FLASHING | Cluster Light<br>FALL LITE | SCREENLIGHT<br>FLASHING | ICICLE# |
|---|--------|---------------------------|------------------------------------|----------------------------|-------------------------|---------|
|    | 192606 | •                         | •                                  |                            | •                       | •       |
|   | 193061 |                           |                                    | •                          |                         |         |
|   | 193078 |                           |                                    | •                          |                         |         |
|  | 192323 |                           |                                    | •                          |                         |         |
|   | 192347 |                           |                                    | •                          |                         |         |
|   | 192354 |                           |                                    | •                          |                         |         |
|   | 192361 |                           |                                    | •                          |                         |         |
|   | 192378 |                           |                                    | •                          |                         |         |
|   | 192385 |                           |                                    | •                          |                         |         |
|   | 192392 |                           |                                    | •                          |                         |         |
|   | 192408 |                           |                                    | •                          |                         |         |
|   | 192415 |                           |                                    | •                          |                         |         |
|   | 192422 |                           |                                    | •                          |                         |         |
|   | 192439 |                           |                                    | •                          |                         |         |
|   | 192446 |                           |                                    | •                          |                         |         |
|   | 388368 |                           |                                    | •                          |                         |         |
|   | 388375 |                           |                                    | •                          |                         |         |
|   | 388382 |                           |                                    | •                          |                         |         |
|   | 388399 |                           |                                    | •                          |                         |         |
|   | 388498 |                           |                                    | •                          |                         |         |
|   | 388504 |                           |                                    | •                          |                         |         |
|   | 391498 |                           |                                    | •                          |                         |         |
|   | 391504 |                           |                                    | •                          |                         |         |

CABLE ALIMENTACIÓN SMART LINK



CABLE ALIMENTACIÓN SMART LINK



|  |  |  |  | <b>W</b> |  |  |
|---|---|---|---|----------|---|---|
| 193061  |  | 230Vac  | Max. 480W   | CII      | IP44 Plug   | IP65 Conector   |
| 193078  |  | 230Vac  | Max. 480W   | CII      | IP44 Plug   | IP65 Conector   |

|  |   |  |  | <b>W</b> |  |  |
|---|---|---|---|----------|---|---|
| 192606  |  | 230Vac  | Max. 480W   | CII      | IP20  |   |



### CONECTOR T SMART LINK

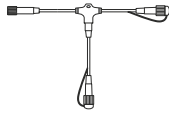

| 192446 |  |  | IP65 |
|--------|--|--|------|
| 192439 |  |  | IP65 |

### CONECTOR X SMART LINK

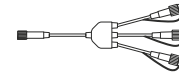

| 391504 |  |  | IP65 |
|--------|--|--|------|
| 391498 |  |  | IP65 |

### CONECTOR 5 SMART LINK

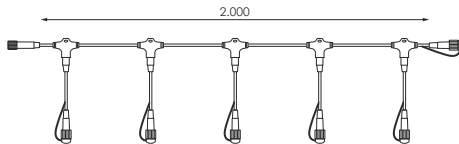

| 388375 | 2m | 5 |  |  | IP65 |
|--------|----|---|--|--|------|
| 388368 | 2m | 5 |  |  | IP65 |

### CONECTOR 10 SMART LINK

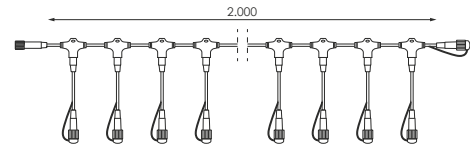

| 388399 | 2m | 10 |  |  | IP65 |
|--------|----|----|--|--|------|
| 388382 | 2m | 10 |  |  | IP65 |

### CONECTOR 10 SMART LINK

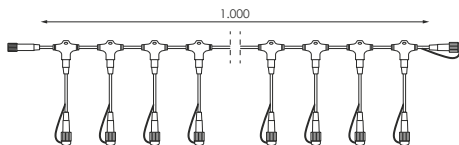

| 192408 | 1m | 10 |  |  | IP65 |
|--------|----|----|--|--|------|
| 192392 | 1m | 10 |  |  | IP65 |

### CONECTOR 20 SMART LINK

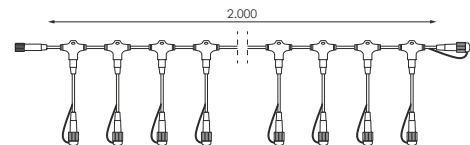

| 192422 | 2m | 20 |  |  | IP65 |
|--------|----|----|--|--|------|
| 192415 | 2m | 20 |  |  | IP65 |

### EXTENSIÓN SMART LINK

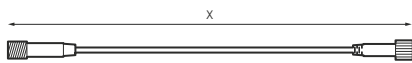

| 388498 | 0,5m |  | IP65 |
|--------|------|--|------|
| 388504 | 0,5m |  | IP65 |
| 192347 | 1m   |  | IP65 |
| 192323 | 1m   |  | IP65 |
| 192361 | 3m   |  | IP65 |
| 192354 | 3m   |  | IP65 |
| 192385 | 5m   |  | IP65 |
| 192378 | 5m   |  | IP65 |





deco





# Cluster

## Microled



⚡ 6V

Hz 50-60Hz

◇ CIII

°° IP20

🌡️ -20°C~+60 °C

TR INC.

🔌 20ud

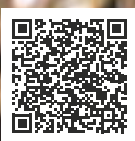

|        |  |  |
|--------|--|--|
|        |  |  |
| 444354 |  |  |

|   |               |
|---|---------------|
| ↔ | 2m            |
|   | 280           |
| W | 5W            |
|   | NO Empalmable |

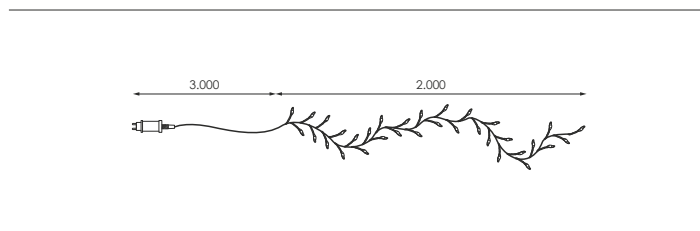





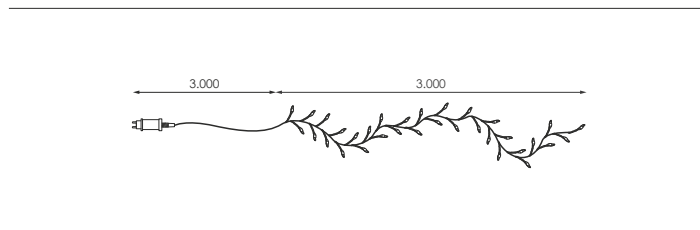

|        |  |  |
|--------|--|--|
|        |  |  |
| 444361 |  |  |

|   |               |
|---|---------------|
| ↔ | 3m            |
|   | 420           |
| W | 6W            |
|   | NO Empalmable |







# Branch String



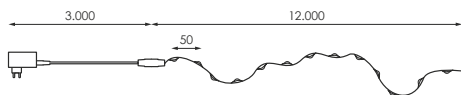

|   |              |
|---|--------------|
|  | 6V           |
| <b>Hz</b>   | 50-60Hz      |
|   | CIII         |
|   | IP20         |
|  | -20°C~+60 °C |
|   | INC.         |
|   | 10ud         |



[GRÁFICOS: Unidades en mm/ GRAPHICS: Units in mm/GRAPHIQUES: Unités en mm/GRÁFICOS: Unidades em mm]



|   |               |
|---|---------------|
|  | 12m           |
|  | 300           |
| <b>W</b>  | 6W            |
|  | NO Empalmable |

|   |   |   |
|---|---|---|
|  |  |  |
| 192705  |  |  |

# Branch Tree



|    |              |
|----|--------------|
| ⚡  | 6V           |
| Hz | 50-60Hz      |
| ◇  | CIII         |
| °  | IP20         |
| 🌡️ | -20°C~+60 °C |
| TR | INC.         |
| 🔌  | 10ud         |



|        |     |    |
|--------|-----|----|
|        | 💡   | ⊖  |
| 192767 | LED | 👁️ |
| 192781 | LED | 👁️ |

|    |               |
|----|---------------|
| ↔️ | 3m            |
| ⦿  | 10            |
| 💡  | 300           |
| W  | 6W            |
| ✖️ | NO Empalmable |

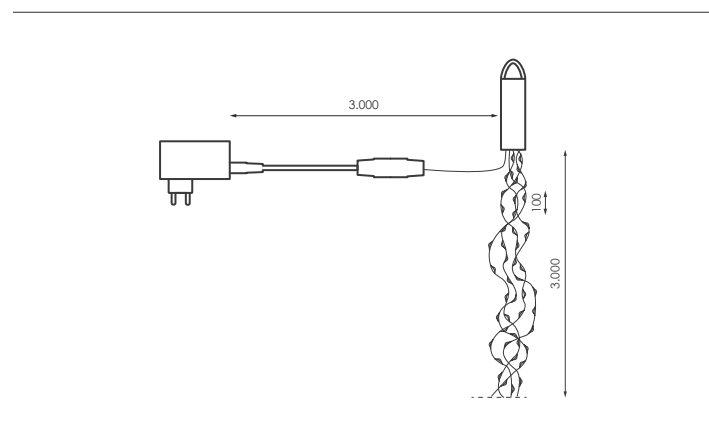

|        |     |    |
|--------|-----|----|
|        | 💡   | ⊖  |
| 192798 | LED | 👁️ |

|    |               |
|----|---------------|
| ↔️ | 3m            |
| ⦿  | 10            |
| 💡  | 300 flashing  |
| W  | 6W            |
| ✖️ | NO Empalmable |

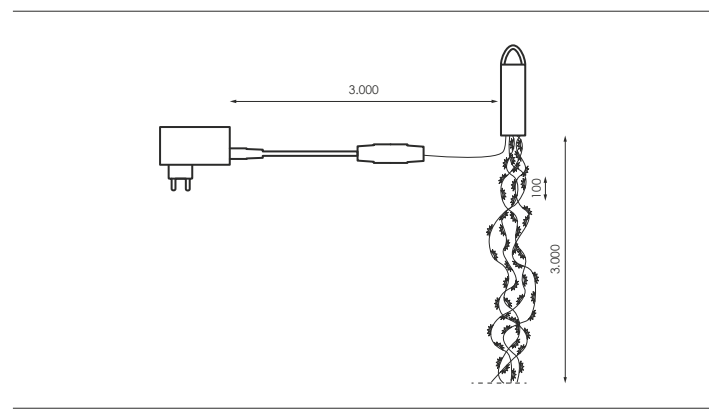



# Solar String

⚡ CIII

☂ IP44

📦 10ud

Ñ/ 2 Funciones: **Fija y flashing.**  
 E/ 2 Functions: **Fixed and flashing.**  
 F/ 2 Fonctions: **Fixes et clignotants.**  
 P/ 2 Funções: **Fixos e intermitentes.**



[GRÁFICOS: Unidades en mm/ GRÁFICOS: Units in mm/GRAPHIQUES: Unités en mm/GRÁFICOS: Unidades em mm]

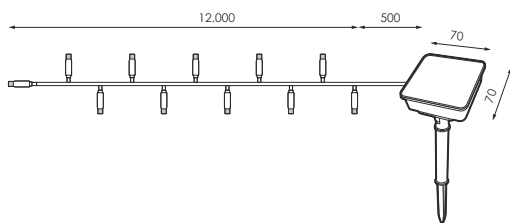

|   |                   |
|---|-------------------|
| ↔ | 12m               |
| ☀ | 0,24W<br>2V/120mA |
| 🔋 | 1,2V/600mA        |
| ⏰ | 8h/carga          |
| ✂ | NO<br>Empalmable  |

|        |     |   |
|--------|-----|---|
|        | 💡   | 🔄 |
| 391177 | LED | 📦 |
| 391160 | LED | 📦 |

# LED Fireworks



|  |              |
|--|--------------|
|  | 24V          |
|  | 50-60Hz      |
|  | CIII         |
|  | IP44         |
|  | -20°C~+60 °C |
|  | INC. 3m      |
|  | 10ud         |

|        |  |  |
|--------|--|--|
|        |  |  |
| 240789 |  |  |

|          |               |
|----------|---------------|
|          | Ø30cm         |
|          | 80            |
| <b>W</b> | 6,7W          |
|          | NO Empalnable |

Transformador **INCLUIDO**  
 Transformer **INCLUDED**  
 Transformateur **INCLUS**  
 Transformador **INCLUIDO**

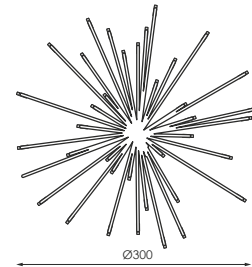

|        |  |  |
|--------|--|--|
|        |  |  |
| 240796 |  |  |
| 441759 |  |  |
| 441780 |  |  |
| 441810 |  |  |

|          |               |
|----------|---------------|
|          | Ø40cm         |
|          | 120           |
| <b>W</b> | 11W           |
|          | NO Empalnable |

Transformador **INCLUIDO**  
 Transformer **INCLUDED**  
 Transformateur **INCLUS**  
 Transformador **INCLUIDO**

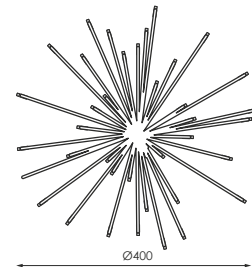

|        |  |  |
|--------|--|--|
|        |  |  |
| 441735 |  |  |
| 441766 |  |  |
| 441797 |  |  |
| 441827 |  |  |

|          |               |
|----------|---------------|
|          | Ø50cm         |
|          | 240           |
| <b>W</b> | 21,5W         |
|          | NO Empalnable |

Transformador **INCLUIDO**  
 Transformer **INCLUDED**  
 Transformateur **INCLUS**  
 Transformador **INCLUIDO**

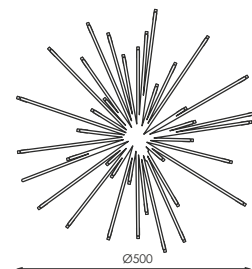

|        |  |  |
|--------|--|--|
|        |  |  |
| 441742 |  |  |
| 441773 |  |  |
| 441803 |  |  |
| 441834 |  |  |

|          |               |
|----------|---------------|
|          | Ø100cm        |
|          | 480           |
| <b>W</b> | 31,4W         |
|          | NO Empalnable |

Transformador **INCLUIDO**  
 Transformer **INCLUDED**  
 Transformateur **INCLUS**  
 Transformador **INCLUIDO**

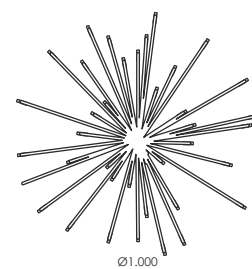

# Giro Snowflake

⚡ 12V

Hz 50-60Hz

⬢ CIII

☉ IP67

Ⓜ INC. 5m

Ⓜ 12ud

**Ñ/ Recomendable** para distancias a pared que no excedan los **8m**.  
**E/ Suitable** for wall distances not exceeding **8m**.  
**F/ Convient** pour des distances de paroi ne dépassant pas **8m**.  
**P/ Adequado** para distâncias de parede não superior a **8m**.



[GRÁFICOS: Unidades en mm/ GRÁFICOS: Units in mm/GRAPHIQUES: Units in mm/GRÁFICOS: Unidades em mm]

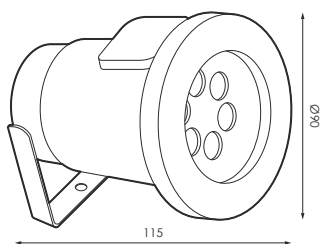

W

8W



392129



LED





Hasta 3 años de garantía.  
Ver condiciones de uso  
**Up to 3 years of warranty**  
See terms of use  
**Jusqu'à 3 ans de garantie**  
Voir condition d'utilisation  
**Alé 3 anos de garantia**  
Ver condições de uso



⚡ 100-240V

Hz 50-60Hz

□ CII

⊙ IP44 (Area Ventilador)

⊙ IP65 (Proyector)

TR INC.

⊙ 2ud

Fotolito de Serie

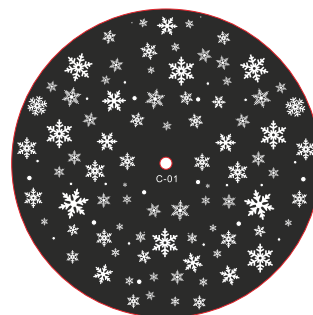

| Barcode | W    | LED | φ       | Δ   |
|---------|------|-----|---------|-----|
| 548335  | 60W  | LED | 3.000lm | 22° |
| 548342  | 100W | LED | 7.000lm | 22° |

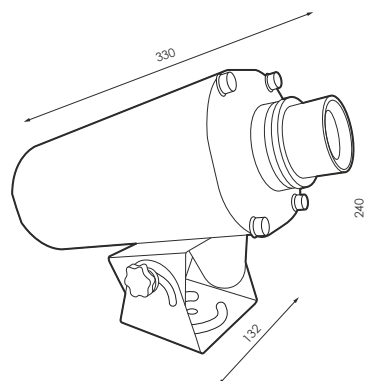
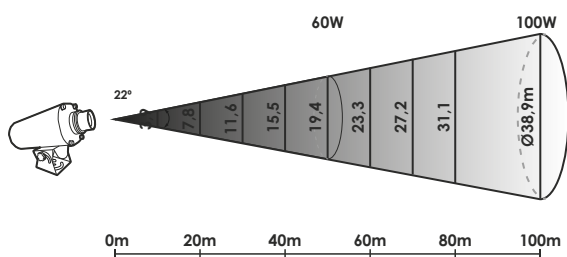

| Diatancia (m) | Nesso 60W<br>22° | Nesso 100W<br>22° |
|---------------|------------------|-------------------|
| 1m            | 7.150Klux        | 15.800Klux        |
| 2m            | 1.780Klux        | 3.550Klux         |
| 3m            | 800Klux          | 1.600Klux         |
| 4m            | 465Klux          | 900Klux           |
| 5m            | 270Klux          | 560Klux           |
| 6m            | 170Klux          | 380Klux           |
| 7m            | 130Klux          | 270Klux           |
| 8m            | 100Klux          | 200Klux           |
| 9m            | 75Klux           | 160Klux           |
| 10m           | 60Klux           | 125Klux           |
| 11m           | 45Klux           | 100Klux           |
| 12m           | 35Klux           | 80Klux            |

Accesorios (NO Incluidos) / Accessoires (NOT Included) / Accessories (NON Inclus) / Acessórios (NÃO Incluso)

600002

Fotolito Muñeco Nieve Color



599993

Fotolito Jengibre Color



600019

Fotolito Papa Noel Color



600033

Fotolito Muñeco Nieve B/N



600026

Fotolito Jengibre B/N

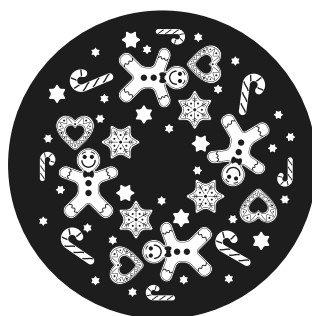

600040

Fotolito Papa Noel B/N

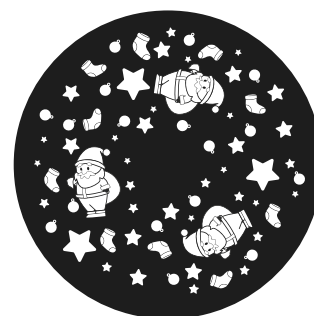

Aviso/Warning/Avertissement/Aviso

**Ñ/** Pérdida del efecto luminoso por contaminación lumínica.

**E/** Loss of the luminous effect due to light pollution.

**F/** Perte de l'effet lumineux dû à la pollution lumineuse.

**P/** Perda do efeito luminoso devido à poluição luminosa.

Información/Information/Information/Informações

**Ñ/** Posibilidad de diseño a medida en la proyección bajo consulta.

**E/** Possibility of custom design in the projection on request.

**F/** Possibilité de conception personnalisée dans la projection sur demande.

**P/** Possibilidade de design personalizado na projeção a pedido.

# Nesso

## Steady



Hasta 3 años de garantía.  
Ver condiciones de uso  
**Up to 3 years of warranty**  
See terms of use  
**Jusqu'à 3 ans de garantie**  
Voir condition d'utilisation  
**Alé 3 anos de garantia**  
Ver condições de uso



⚡ 230V

Hz 50-60Hz

☐ CII

⊙ IP44 (Area Ventilador)  
⊙ IP65 (Proyector)

TR INC.

📦 2ud

Fotolito de Serie



| Barcode | W    | LED | φ       | ∠   |
|---------|------|-----|---------|-----|
| 513272  | 60W  | LED | 3.000lm | 20° |
| 599924  | 100W | LED | 7.000lm | 20° |

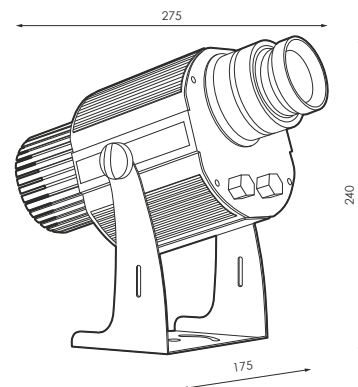
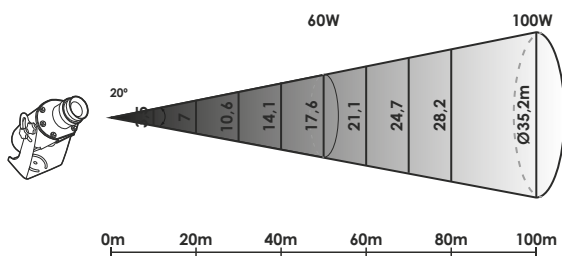



| Diatancia (m) | Nesso Steady 60W<br>20° | Nesso Steady 100W<br>20° |
|---------------|-------------------------|--------------------------|
| 1m            | 10.760Klux              | 18.790Klux               |
| 2m            | 2.600Klux               | 4.500Klux                |
| 3m            | 1.150Klux               | 2.100Klux                |
| 4m            | 670Klux                 | 1.170Klux                |
| 5m            | 410Klux                 | 740Klux                  |
| 6m            | 270Klux                 | 490Klux                  |
| 7m            | 190Klux                 | 360Klux                  |
| 8m            | 150Klux                 | 320Klux                  |
| 9m            | 115Klux                 | 210Klux                  |
| 10m           | 90Klux                  | 170Klux                  |
| 11m           | 70Klux                  | 140Klux                  |
| 12m           | 65Klux                  | 120Klux                  |

Accesorios (NO Incluidos) / Accessoires (NOT Included) / Accessories (NON Inclus) / Acessórios (NÃO Incluso)

599948

Fotolito Muñeco Nieve Color



599931

Fotolito Jengibre Color



599955

Fotolito Papa Noel Color



599979

Fotolito Muñeco Nieve B/N



599962

Fotolito Jengibre B/N



599986

Fotolito Papa Noel B/N



Aviso/Warning/Avertissement/Aviso

**Ñ/** Pérdida del efecto luminoso por contaminación lumínica.

**E/** Loss of the luminous effect due to light pollution.

**F/** Perte de l'effet lumineux dû à la pollution lumineuse.

**P/** Perda do efeito luminoso devido à poluição luminosa.

Información/Information/Information/Informações

**Ñ/** Posibilidad de diseño a medida en la proyección bajo consulta.

**E/** Possibility of custom design in the projection on request.

**F/** Possibilité de conception personnalisée dans la projection sur demande.

**P/** Possibilidade de design personalizado na projeção a pedido.

# Willow Light

1m

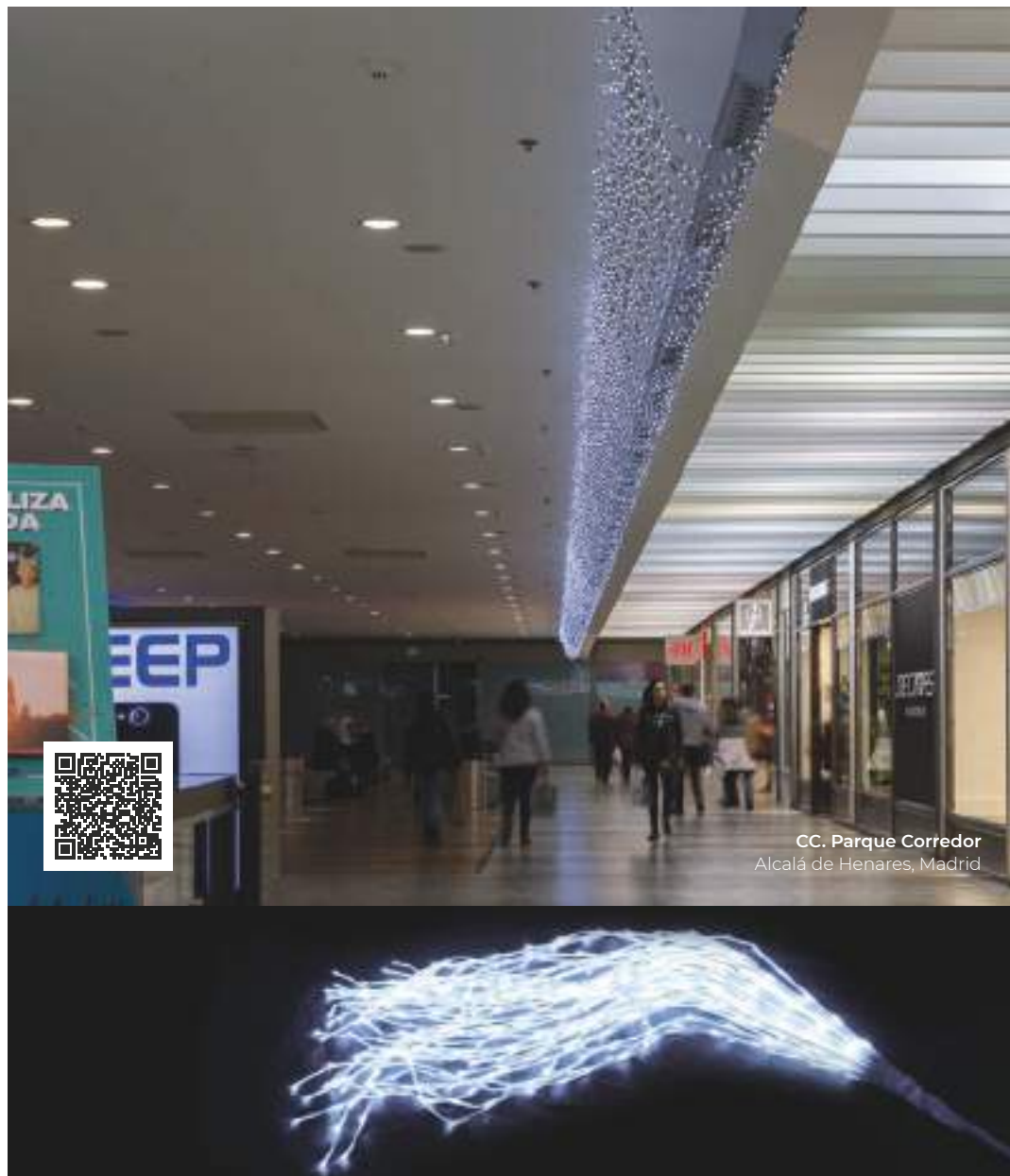

⚡ 24V

Hz 50-60Hz

◇ CIII

⊙ IP44

TR INC. 6,2m

3ud (1m)

⊕ 2ud (1,8m)

1ud (3m)



CC. Parque Corredor  
Alcalá de Henares, Madrid



|        |  |  |
|--------|--|--|
|        |  |  |
| 391399 |  |  |
| 391405 |  |  |

|   |                  |
|---|------------------|
|   | 1m               |
|   | 40               |
|   | 640              |
| W | 59,3W            |
|   | NO<br>Empalmable |

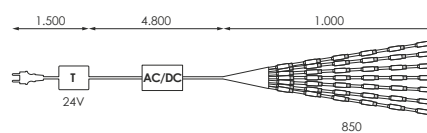

Accesorios (NO Incluidos) / Accessoires (NOT Included) / Accessories (NON Inclus) / Acessórios (NÃO Incluso)

+ INFO PAG. 506

401388

Soporte de pared

# Willow Light

1,8m

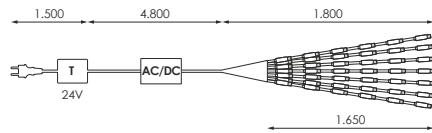

|   |               |        |     |    |
|---|---------------|--------|-----|----|
| ↔ | 1,8m          |        | 💡   | ∞  |
| 🔗 | 40            | 391412 | LED | 👁️ |
| 💡 | 1.280         | 391429 | LED | 👁️ |
| W | 77,7W         |        |     |    |
| 🚫 | NO Empalmable |        |     |    |

# Willow Light

3m

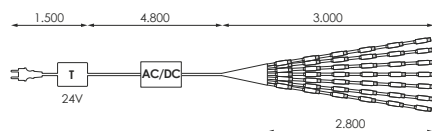

|   |               |        |     |    |
|---|---------------|--------|-----|----|
| ↔ | 3m            |        | 💡   | ∞  |
| 🔗 | 40            | 391443 | LED | 👁️ |
| 💡 | 2.240         |        |     |    |
| W | 90,1W         |        |     |    |
| 🚫 | NO Empalmable |        |     |    |



# LED Fountain



⚡ 24V

Hz 50-60Hz

◇ CIII

⊙ IP44

TR INC.

⊕ 1ud

Ñ/ Transformador efecto cascada **INCLUIDO** (4 velocidades y fijo).

E/ Transformer waterfall effect **INCLUDED** (4-speed and fixed).

F/ Transformateur cascade d'effet **INCLUS** (4 vitesses et une fixe).

P/ Transformador cachoeira de efeito **INCLUIDO** (4-speed e fixo).



|        |     |   |
|--------|-----|---|
|        | 💡   | ⊙ |
| 192811 | LED | 📍 |
| 192828 | LED | 📍 |

|   |               |
|---|---------------|
| ↔ | 1,5m          |
| ⊙ | Ø70cm         |
| 💡 | 1584          |
| W | 42,96W        |
| ⊗ | NO Empalmable |

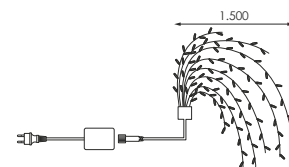

Accesorios (NO Incluidos) / Accessoires (NOT Included) / Accessories (NON Inclus) / Acessórios (NÃO Incluso)

+ INFO PAG. 506

401371

Soporte de pared

# Deco Branch

⚡ 24V

Hz 50-60Hz

⬮ CIII

☉ IP44

Ⓜ INC.

📦 1ud

Ñ/ Posibilidad de separar la rama en 2 partes.  
 E/ Possibility of separating the branch into 2 parts.  
 F/ Possibilité de séparer la branche en 2 parties.  
 P/ Possibilidade de separar a filial em 2 partes.



[GRÁFICOS: Unidades en mm/ GRÁFICOS: Units in mm/GRAPHIQUES: Unités en mm/GRÁFICOS: Unidades em mm]

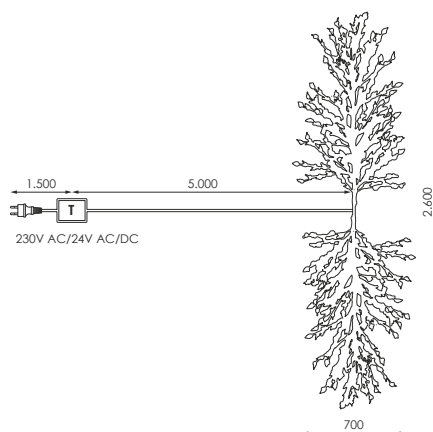

|   |               |
|---|---------------|
| ↕ | 2,6x0,7m      |
| 💡 | 600           |
| W | 48W           |
| ✂ | NO Empalmable |

|        |     |   |
|--------|-----|---|
|        | 💡   | ⊕ |
| 953634 | LED | 👁 |
| 512909 | LED | 👁 |

# Branch *LED*

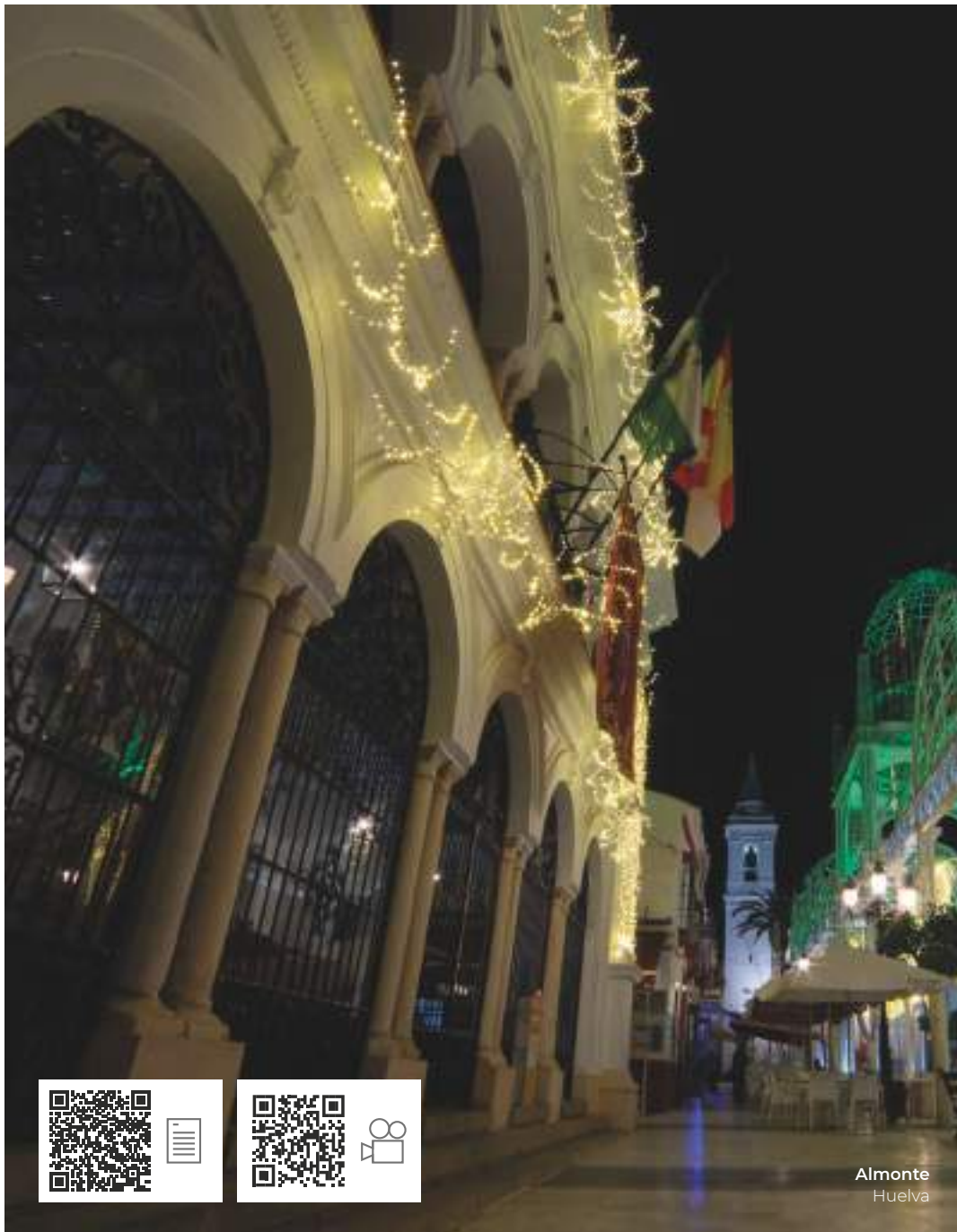

⚡ 24V dc

Hz 50-60Hz

◇ CIII

°° IP44

TR INC.

Ⓜ 6ud

Almonte  
Huelva

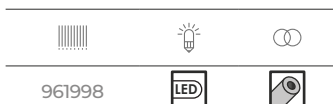

961998

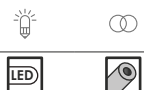

|   |                  |
|---|------------------|
| ↔ | 3,6m             |
| 💡 | 288              |
| W | 16W              |
| ⊗ | NO<br>Empalmable |

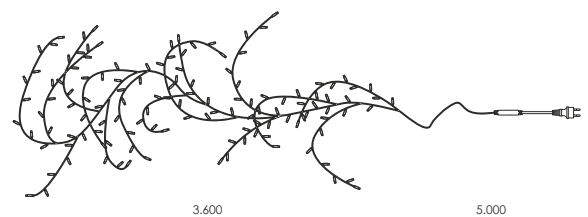





3.600





5.000

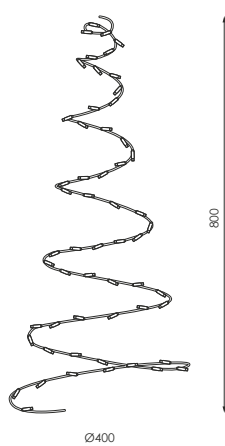

# Spiral

|  |         |
|--|---------|
|  | 24V     |
| <b>Hz</b>  | 50-60Hz |
|  | CIII    |
|  | IP44    |
|  | INC. 3m |
|  | 1ud     |



|   |               |   |   |   |
|---|---------------|---|---|---|
|  | Ø40x80cm      |  |  |  |
|  | 120           | 210522  |  |  |
| <b>W</b>  | 5,8W          |   |   |   |
|  | NO Empalmable |   |   |   |

# Snow Tree



CC. Alhambra  
Ecuador

⚡ 24V ac

Hz 50-60Hz

◇ CIII

⊙ IP20

TR INC. 3m

⊞ 1ud

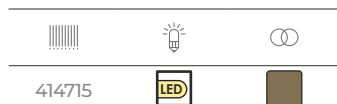

414715



|   |               |
|---|---------------|
| ↕ | 1,5m          |
| 💡 | 186           |
| W | 7,2W          |
| ✘ | NO Empalmable |

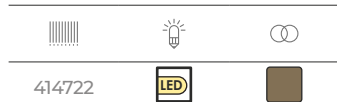

414722



|   |               |
|---|---------------|
| ↕ | 1,8m          |
| 💡 | 270           |
| W | 9,6W          |
| ✘ | NO Empalmable |

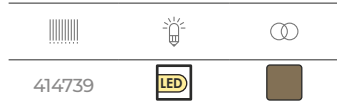

414739



|   |               |
|---|---------------|
| ↕ | 2,1m          |
| 💡 | 306           |
| W | 12W           |
| ✘ | NO Empalmable |

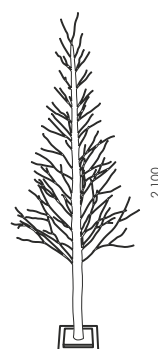
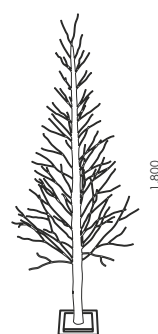
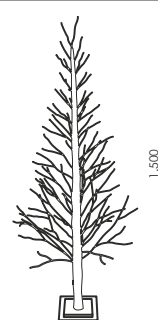





# Golden Tree

|  |         |
|--|---------|
|  | 24V ac  |
| <b>Hz</b>  | 50-60Hz |
|  | CIII    |
|  | IP20    |
|  | INC. 3m |
|  | 1ud     |

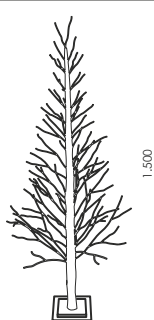





[GRÁFICOS: Unidades en mm/ GRÁFICOS: Units in mm/GRAPHIQUES: Unités en mm/GRÁFICOS: Unidades em mm]

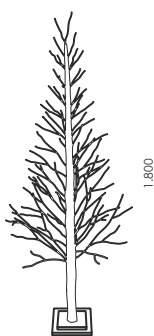

|   |               |
|---|---------------|
|   | 1,5m          |
|  | 186           |
| <b>W</b>  | 7,2W          |
|  | NO Empalmable |



|  |   |   |
|--|---|---|
|  |   |   |
| 414746   |  |  |





|   |               |
|---|---------------|
|  | 1,8m          |
|  | 270           |
| <b>W</b>  | 9,6W          |
|  | NO Empalmable |

|   |   |   |
|---|---|---|
|  |  |  |
| 414753  |  |  |



|   |               |
|---|---------------|
|  | 2,1m          |
|  | 306           |
| <b>W</b>  | 12W           |
|  | NO Empalmable |

|   |   |   |
|---|---|---|
|  |  |  |
| 414760  |  |  |



# Willow Tree

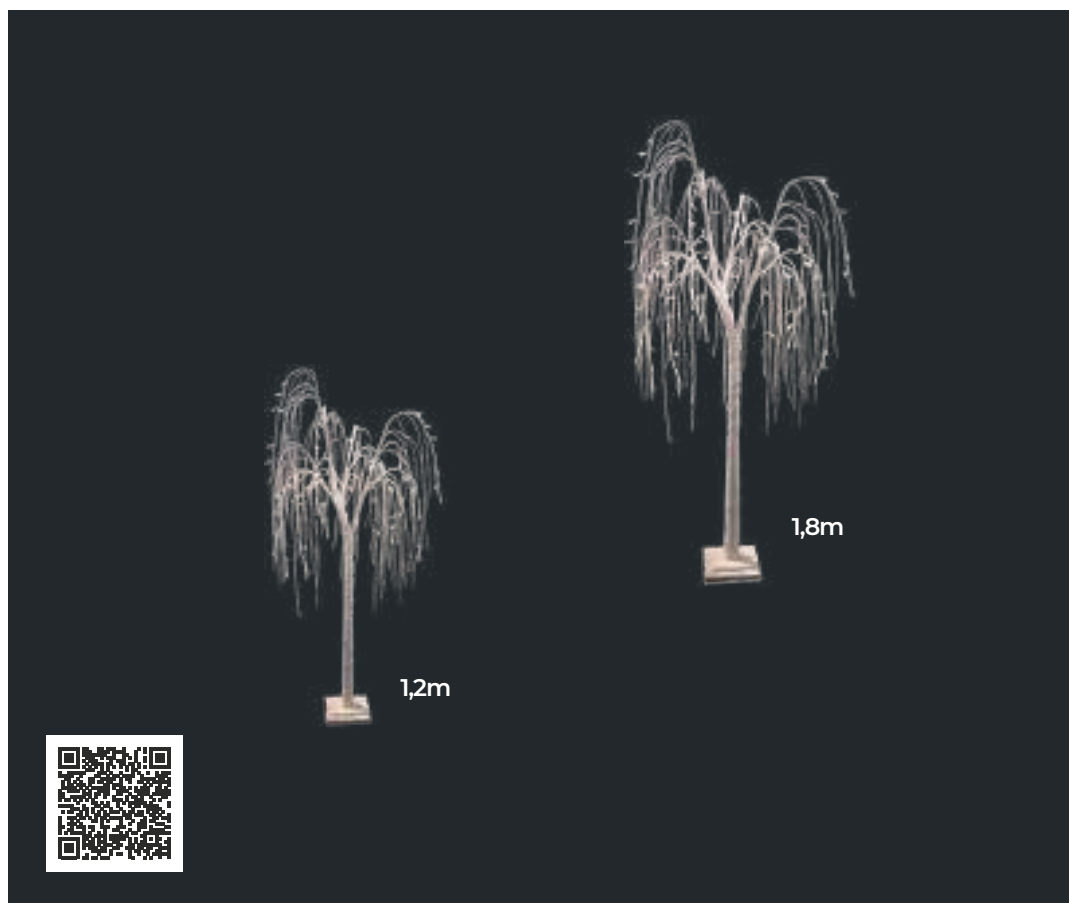

⚡ 31V ac

Hz 50-60Hz

◇ CIII

⊙ IP44

📦 1ud

|        |     |   |
|--------|-----|---|
|        | 💡   | ∞ |
| 390576 | LED | □ |

|    |               |
|----|---------------|
| ↕  | 1,2m          |
| 💡  | 66            |
| W  | 2,64W         |
| ✘  | NO Empalmable |
| TR | INC. 3m       |





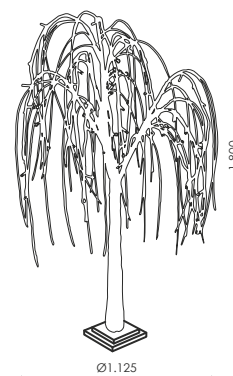

|          |     |   |
|----------|-----|---|
|          | 💡   | ∞ |
| N 600613 | LED | □ |



|    |               |
|----|---------------|
| ↕  | 1,8m          |
| 💡  | 360           |
| W  | 3,6W          |
| ✘  | NO Empalmable |
| TR | INC. 5m       |



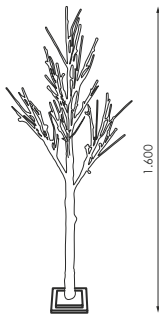
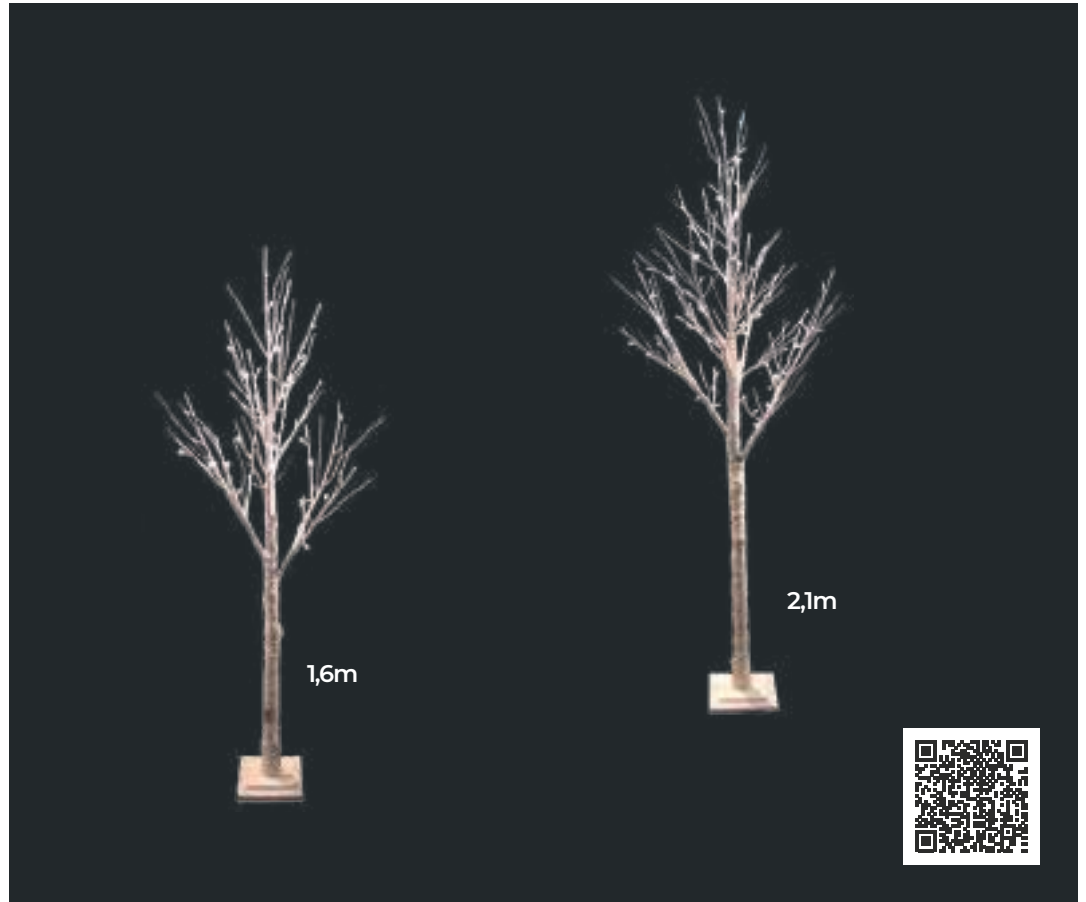

# Birch Tree



|   |         |
|---|---------|
|  | 24V ac  |
| <b>Hz</b>   | 50-60Hz |
|   | CIII    |
|   | IP20    |
|   | INC. 3m |
|   | 1ud     |





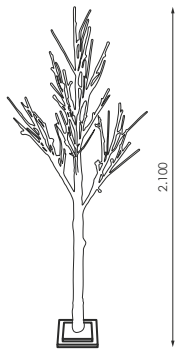

|   |               |
|---|---------------|
|  | 1,6m          |
|  | 54            |
| <b>W</b>  | 2,16W         |
|  | NO Empalmable |

|   |   |   |
|---|---|---|
|  |  |  |
| 390866  |  |  |



|   |               |
|---|---------------|
|  | 2,1m          |
|  | 90            |
| <b>W</b>  | 3,6W          |
|  | NO Empalmable |

|   |   |   |
|---|---|---|
|  |  |  |
| 390873  |  |  |

[GRÁFICOS: Unidades en mm/ GRÁFICOS: Units in mm/GRAPHIQUES: Unités en mm/GRÁFICOS: Unidades em mm]

# Birch Forest Tree

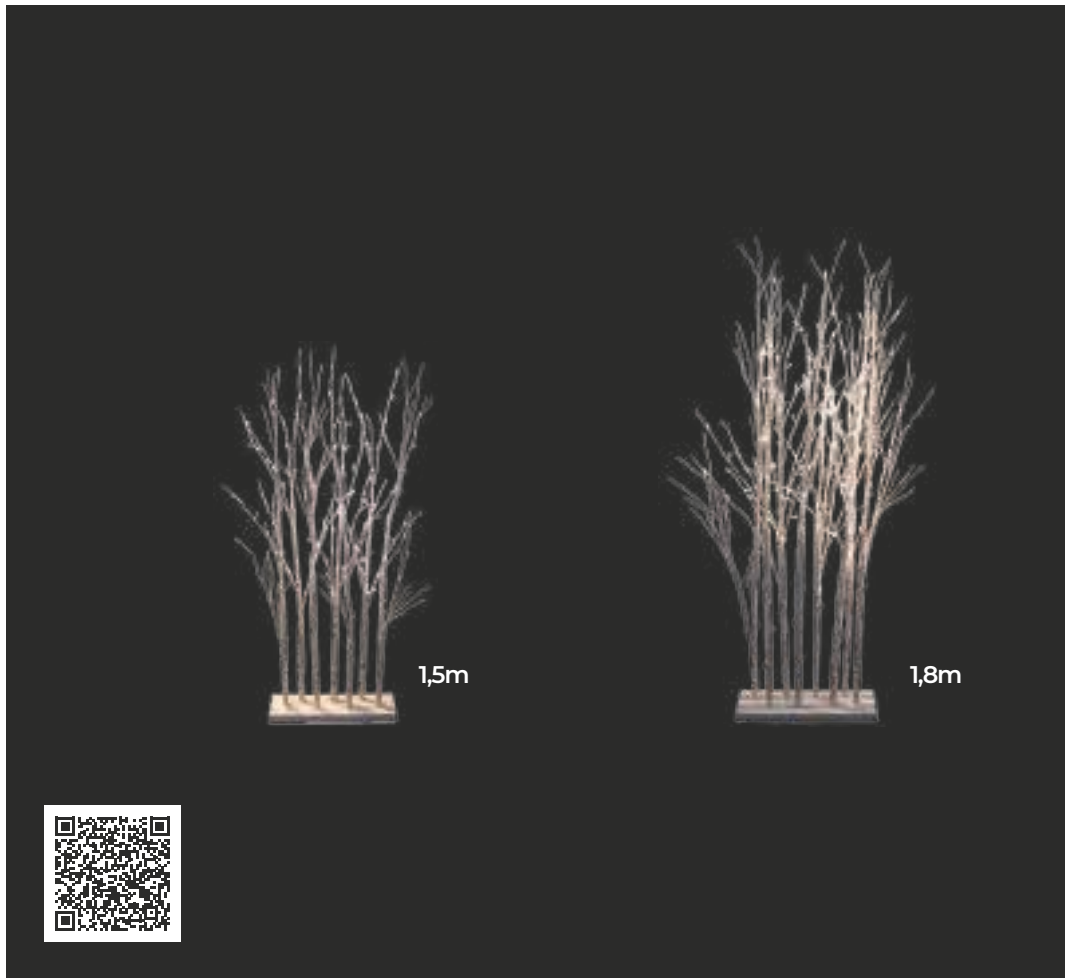

|    |         |
|----|---------|
| ⚡  | 24V     |
| Hz | 50-60Hz |
| ◇  | CIII    |
| ⊙  | IP44    |
| TR | INC. 3m |
| ⊞  | 1ud     |

|        |     |   |
|--------|-----|---|
|        | 💡   | ⊞ |
| 390880 | LED | □ |

|   |               |
|---|---------------|
| ↕ | 1,5m          |
| 💡 | 120           |
| W | 3,6W          |
| ✗ | NO Empalmable |

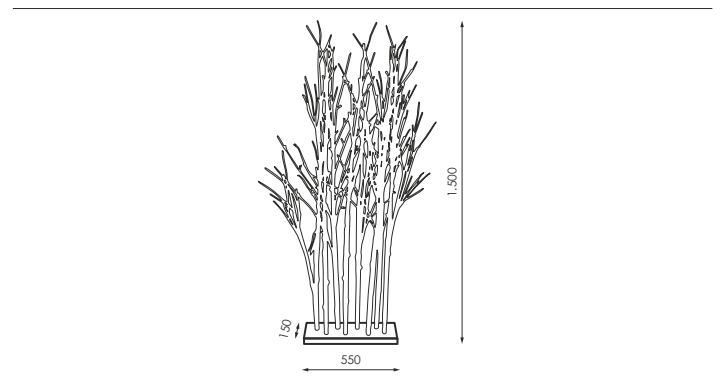

|        |     |   |
|--------|-----|---|
|        | 💡   | ⊞ |
| 390897 | LED | □ |

|   |               |
|---|---------------|
| ↕ | 1,8m          |
| 💡 | 128           |
| W | 3,84W         |
| ✗ | NO Empalmable |

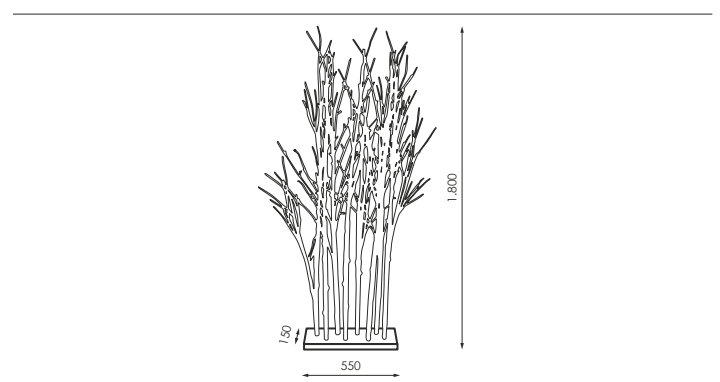



# Winter Tree

⚡ 24V

Hz 50-60Hz

⬮ CIII

⊙ IP44

TR INC. 5m

📦 1ud

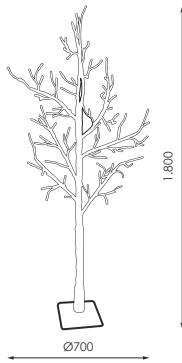

↕ 1,8m

💡 96

W 3,6W

❌ NO Empalmable

||||| ⚡ ⊙



240857

LED

■

# Green Christmas Tree





|  |  |
|---|---|
| 977425  | Ø55~60x150cm  |
| 977432  | Ø60~70x180cm  |
| 977449  | Ø80~85x210cm  |



# Snowy Christmas Tree



|  |  |
|---|---|
| 977456  | Ø55~60x150cm  |
| 977463  | Ø60~70x180cm  |
| 977470  | Ø80~85x210cm  |









# Retail

Magnetismo Visual



En Prilux somos especialistas en la decoración e iluminación de espacios RETAIL como escaparates, tiendas, sets, corners... que convierte tu negocio en el foco de todas las miradas.





At Prilux we are specialists in the decoration and lighting of RETAIL spaces such as shop windows, shops, sets, corners ... that turns your business into the focus of all eyes.

A Prilux nous sommes spécialisés dans la décoration et l'éclairage des espaces RETAIL tels que: les vitrines des magasins, des magasins, des ensembles, des coins ... qui transforme votre entreprise dans le foyer de tous les yeux.

No Prilux somos especialistas na decoração e iluminação de espaços RETAIL: como vitrines, lojas, jogos, cantos ... que transforma o seu negócio para o foco de todas as atenções.



# Star Gold Line 3D





|   |         |
|---|---------|
|  | 4,6V    |
| <b>Hz</b>   | 50-60Hz |
|   | CIII    |
|   | IP20    |
|   | INC. 5m |
|   | 4ud     |



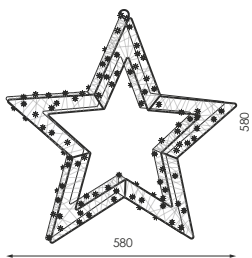



Canarias





[GRÁFICOS: Unidades en mm/ GRÁFICOS: Units in mm/GRAPHIQUES: Unités en mm/GRÁFICOS: Unidades em mm]



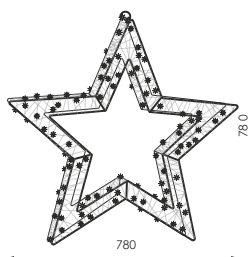



|   |                  |
|---|------------------|
|  | 58x58x8cm        |
|  | 160              |
| <b>W</b>  | 1,35W            |
|  | NO Empalmable    |
|  | Interior Indoors |

|   |   |   |
|---|---|---|
|  |  |  |
| 444484  |  |  |



|   |                  |
|---|------------------|
|  | 78x78x12cm       |
|  | 240              |
| <b>W</b>  | 1,35W            |
|  | NO Empalmable    |
|  | Interior Indoors |

|   |   |   |
|---|---|---|
|  |  |  |
| 444491  |  |  |

# Star Flat



⚡ 4,5V

Hz 50-60Hz

◇ CIII

° IP20

TR INC. 3m

6ud

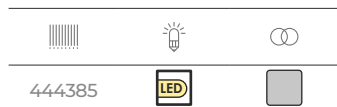

|   |                  |
|---|------------------|
| ↕ | 50x50cm          |
| 💡 | 60               |
| W | 1,35W            |
| ✖ | NO Empalmable    |
| 🏠 | Interior Indoors |

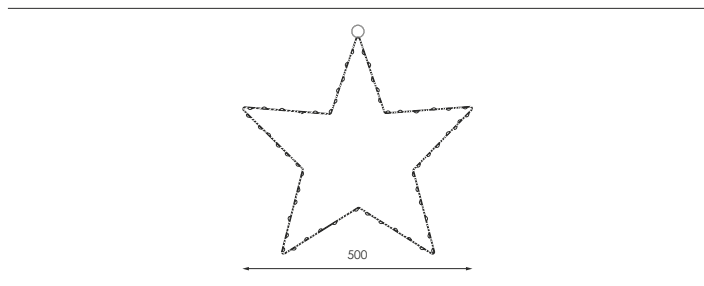

# Star Copper



⚡ 24V

Hz 50-60Hz

◇ CIII

° IP20

TR INC. 5m

6ud

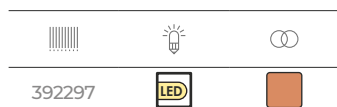



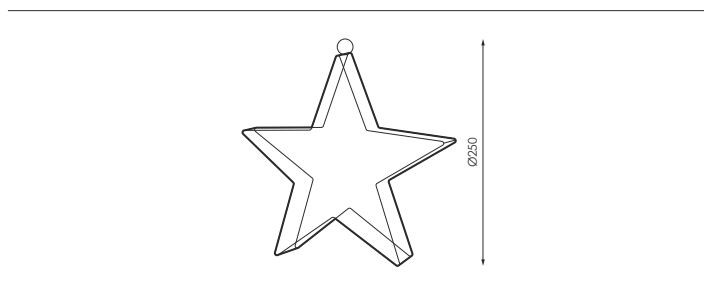

|   |                  |
|---|------------------|
| ↕ | 25x25cm          |
| 💡 | 15               |
| W | 3W               |
| ✖ | NO Empalmable    |
| 🏠 | Interior Indoors |









# Star Glass Balls





|   |         |
|---|---------|
|  | 3,2V    |
| <b>Hz</b>   | 50-60Hz |
|   | CIII    |
|   | IP20    |
|   | INC. 3m |
|   | 12ud    |







|   |                  |
|---|------------------|
|    | Ø13cm            |
|    | 1                |
|    | 15               |
| <b>W</b>  | 0,96W            |
|    | NO Empalmable    |
|  | Interior Indoors |

|   |   |
|---|---|
|  |  |
| 444521  |  |

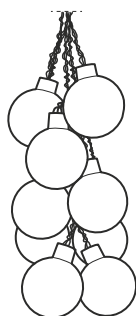
# Cluster Glass Balls

|   |         |
|---|---------|
|  | 3,2V    |
| <b>Hz</b>   | 50-60Hz |
|   | CIII    |
|   | IP20    |
|   | INC. 3m |
|   | 8ud     |



|   |                  |
|---|------------------|
|  | Ø8cm             |
|  | 10               |
| <b>W</b>  | 0,96W            |
|  | NO Empalmable    |
|  | Interior Indoors |

|   |   |
|---|---|
|  |  |
| 444538  |  |

# Cotton Balls



⚡ 3,2V

Hz 50-60Hz

◇ CIII

⊙ IP20

TR INC. 3m

⊞ 12ud

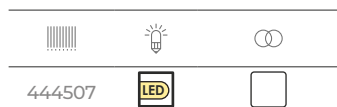

444507



∅ Ø6cm

⊞ 10

W 0,64W

✘ NO Empalmable

🏠 Interior Indoors

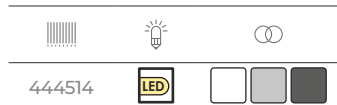
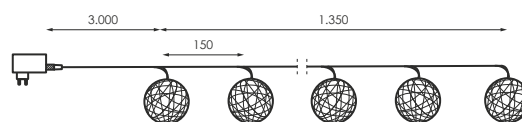

444514



∅ Ø6cm

⊞ 16

W 0,64W

✘ NO Empalmable



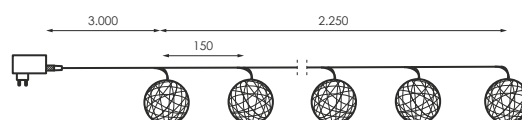

🏠 Interior Indoors

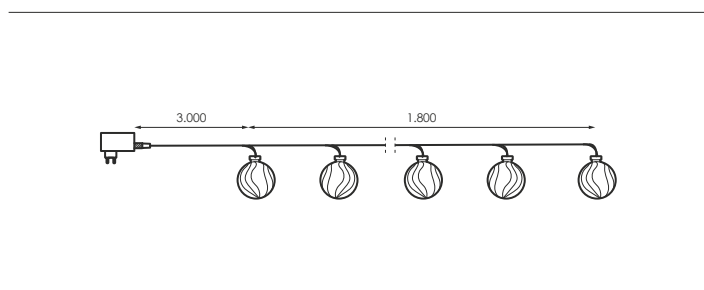

# Glass Balls Chain

|  |         |
|--|---------|
|  | 3,2V    |
| <b>Hz</b>  | 50-60Hz |
|  | CIII    |
|  | IP20    |
|  | INC. 3m |
|  | 12ud    |







|   |                  |
|---|------------------|
|    | Ø6cm             |
|    | 10               |
| <b>W</b>  | 0,96W            |
|    | NO Empalmable    |
|  | Interior Indoors |

|   |   |
|---|---|
|  |  |
| 444552  |  |

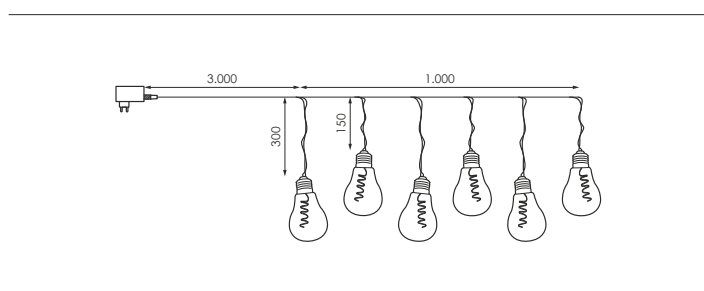
# EsSense Plastic Balls

|  |         |
|--|---------|
|  | 3,2V    |
| <b>Hz</b>  | 50-60Hz |
|  | CIII    |
|  | IP20    |
|  | INC. 3m |
|  | 8ud     |



|   |                  |
|---|------------------|
|  | Ø9cm             |
|  | 6                |
| <b>W</b>  | 0,96W            |
|  | NO Empalmable    |
|  | Interior Indoors |

|   |   |
|---|---|
|  |  |
| 444545  |  |



# Spike Star

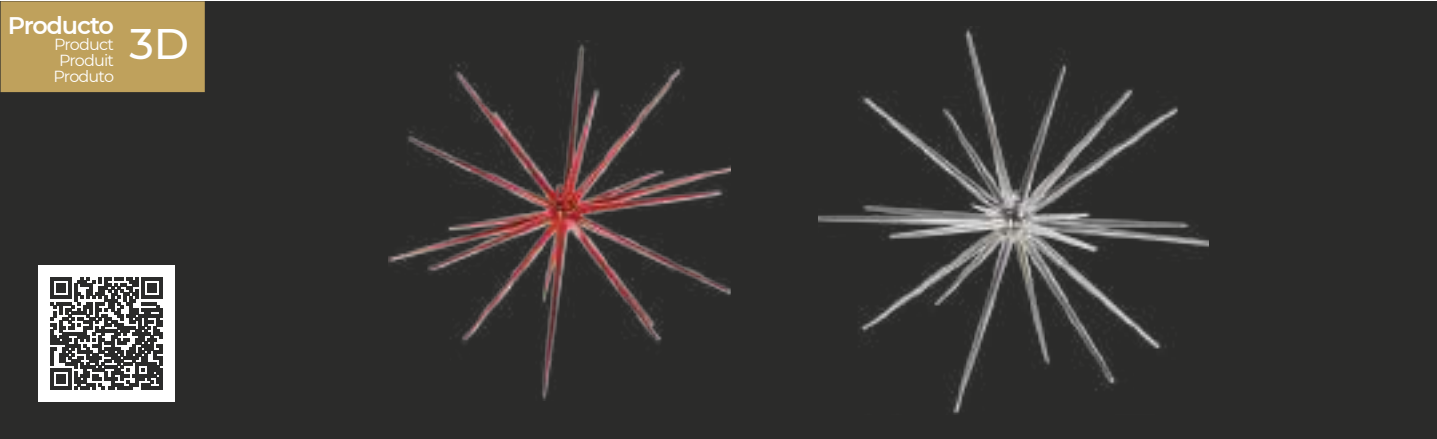

|        |  |      |
|--------|--|------|
|        |  |      |
| 392181 |  | 60cm |
| 392198 |  | 60cm |

Interior  
Indoors

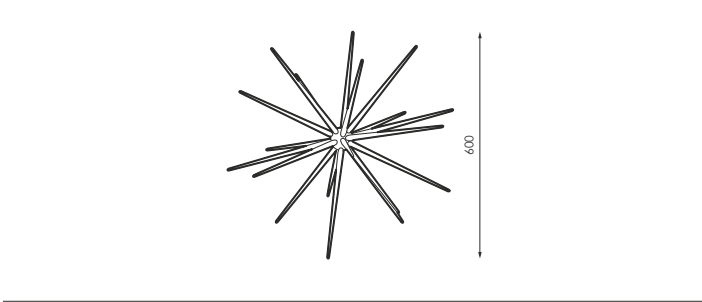

# Glitter Star

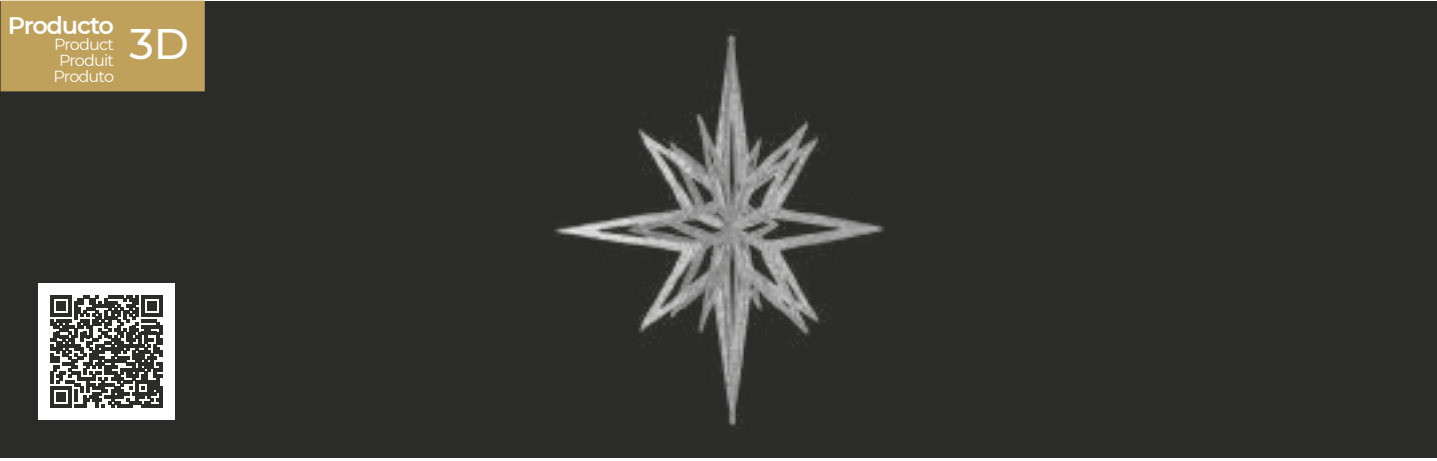

|        |  |      |
|--------|--|------|
|        |  |      |
| 389198 |  | 60cm |

Interior  
Indoors

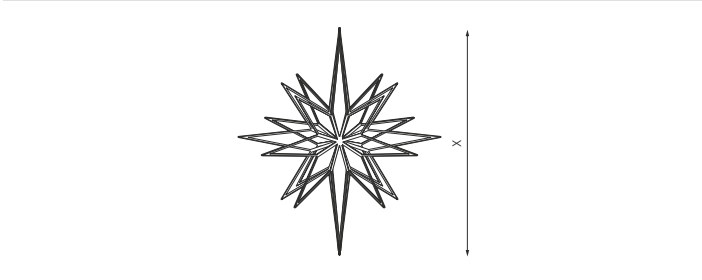

# Glitter Loop



3D Producto  
Product  
Produit  
Produto

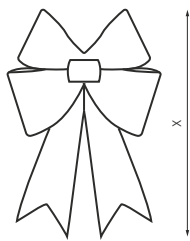

|  |                     |        |  |      |
|--|---------------------|--------|--|------|
|  | Interior<br>Indoors |        |  |      |
|  |                     | 414777 |  | 46cm |
|  |                     | 389228 |  | 76cm |
|  |                     | 389242 |  | 76cm |
|  |                     | 414784 |  | 76cm |
|  |                     | 414807 |  | 76cm |

# Candy Cane

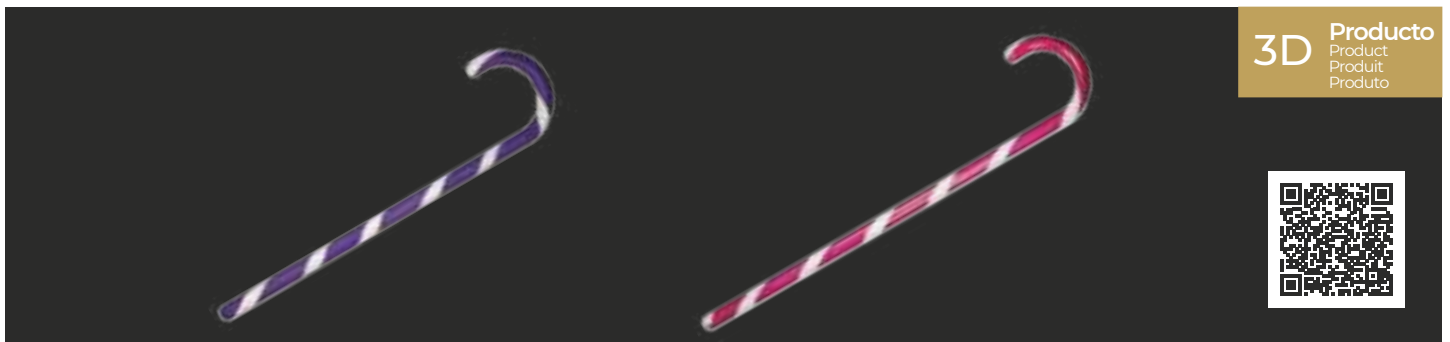

3D Producto  
Product  
Produit  
Produto

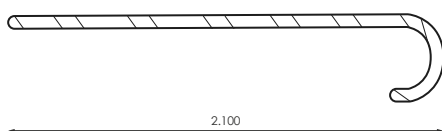
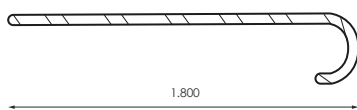

|  |                     |        |  |
|--|---------------------|--------|--|
|  | 180x7,5x46cm        |        |  |
|  | Interior<br>Indoors | 389129 |  |
|  | 210x7,5x46cm        |        |  |
|  | Interior<br>Indoors | 389112 |  |

# Ocean Comet



|    |         |
|----|---------|
| ⚡  | 24V     |
| Hz | 50-60Hz |
| ◇  | CIII    |
| ⊙  | IP20    |
| TR | INC. 3m |
| 📦  | 1ud     |

|        |     |   |
|--------|-----|---|
|        | 💡   | ⊙ |
| 240734 | LED |   |

|   |                           |
|---|---------------------------|
| ↕ | 55x67cm                   |
| 💡 | 24                        |
| W | 1,44W                     |
| ⊗ | NO Empalmable             |
| 🏠 | Interior Indoors          |
| ⤴ | Para suspender To suspend |

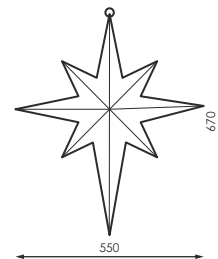

# Ocean Star



|    |         |
|----|---------|
| ⚡  | 24V     |
| Hz | 50-60Hz |
| ◇  | CIII    |
| ⊙  | IP20    |
| TR | INC. 3m |
| 📦  | 1ud     |

|        |     |   |
|--------|-----|---|
|        | 💡   | ⊙ |
| 240741 | LED |   |

|   |                           |
|---|---------------------------|
| ↕ | 40x40cm                   |
| 💡 | 24                        |
| W | 1,44W                     |
| ⊗ | NO Empalmable             |
| 🏠 | Interior Indoors          |
| ⤴ | Para suspender To suspend |

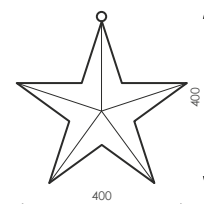



# Ocean Cone





|   |         |
|---|---------|
|  | 24V     |
| <b>Hz</b>   | 50-60Hz |
|   | CIII    |
|   | IP20    |
|   | INC. 3m |
|   | 1ud     |



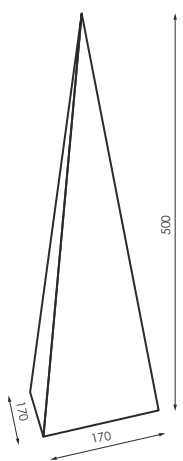



**3D** Product  
Product  
Produit  
Prodotto

[GRÁFICOS: Unidades en mm/ GRAPHICS: Units in mm/ GRAPHIQUES: Unités en mm/ GRÁFICOS: Unidades em mm]



|   |                  |
|---|------------------|
|  | 50x17x17cm       |
|  | 16               |
| <b>W</b>  | 0,96W            |
|  | NO Empalmable    |
|  | Interior Indoors |

|   |   |   |
|---|---|---|
|  |  |  |
| 240758  |  |  |

# Elegant Cone



Producto  
Product  
Produit  
Produto

3D

|    |         |
|----|---------|
| ⚡  | 31V     |
| Hz | 50-60Hz |
| ◇  | CIII    |
| ⊙  | IP44    |
| TR | INC.    |
| Ⓜ  | 1ud     |

|        |     |   |
|--------|-----|---|
|        | 💡   | ∞ |
| 547819 | LED | ■ |

|   |                  |
|---|------------------|
| ↕ | 80x20x20cm       |
| 💡 | 40               |
| W | 3,6W             |
| ✗ | NO Empalmable    |
| 🏠 | Interior Indoors |

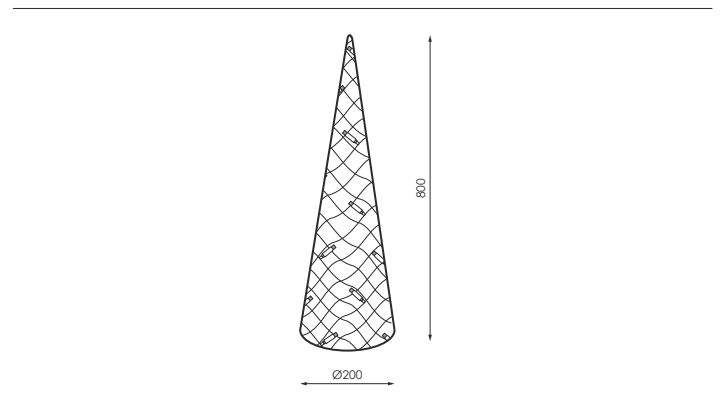



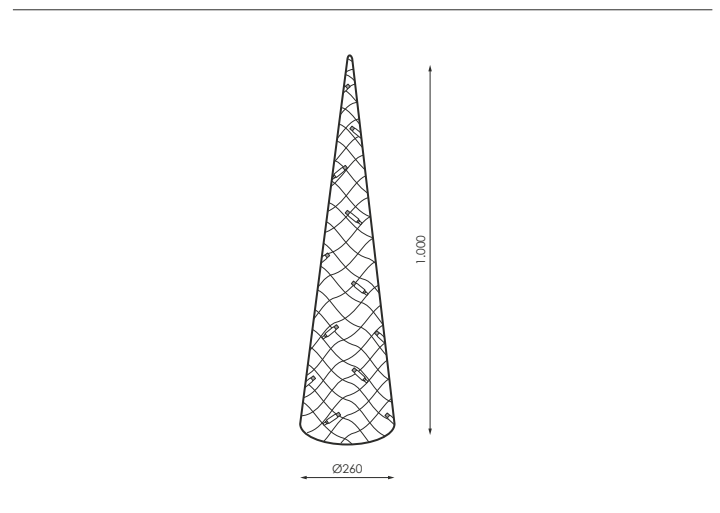

|        |     |   |
|--------|-----|---|
|        | 💡   | ∞ |
| 547826 | LED | ■ |

|   |                  |
|---|------------------|
| ↕ | 100x26x26cm      |
| 💡 | 70               |
| W | 3,6W             |
| ✗ | NO Empalmable    |
| 🏠 | Interior Indoors |









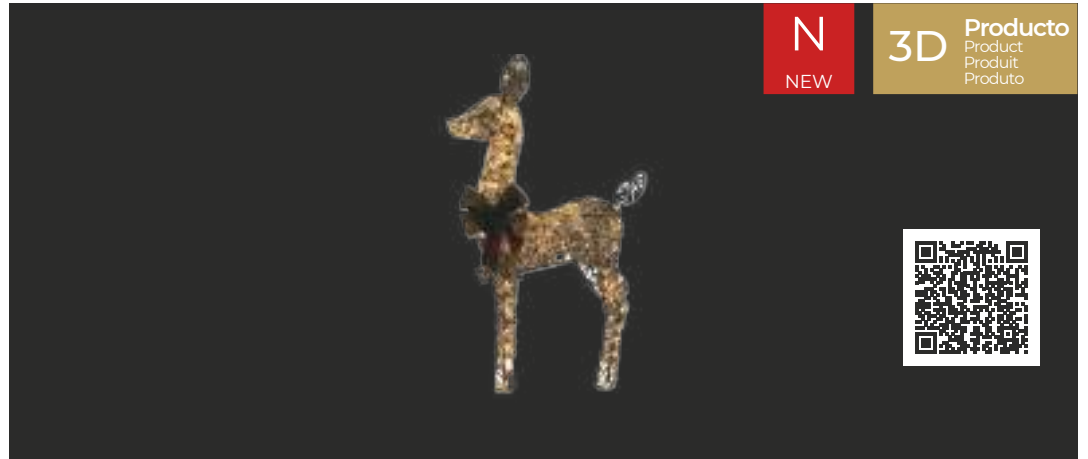

# Elegant Deer

81cm

|   |         |
|---|---------|
|  | 31V     |
| <b>Hz</b>   | 50-60Hz |
|  | CIII    |
|  | IP44    |
|  | INC.    |
|  | 1ud     |







|   |                  |
|---|------------------|
|    | 81cm             |
|    | 70               |
| <b>W</b>  | 3,6W             |
|    | NO Empalmable    |
|  | Interior Indoors |





|   |   |   |
|---|---|---|
|  |  |  |
| 632799  |  |  |

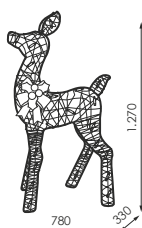

# Elegant Deer

122cm

|   |         |
|---|---------|
|  | 31V     |
| <b>Hz</b>   | 50-60Hz |
|  | CIII    |
|  | IP44    |
|  | INC.    |
|  | 1ud     |



|   |                  |
|---|------------------|
|  | 122cm            |
|  | 120              |
| <b>W</b>  | 6W               |
|  | NO Empalmable    |
|  | Interior Indoors |

|   |   |   |
|---|---|---|
|  |  |  |
| 632782  |  |  |



# Elegant Deer

132cm



|    |         |
|----|---------|
| ⚡  | 31V     |
| Hz | 50-60Hz |
| ◇  | CIII    |
| ⊙  | IP44    |
| TR | INC.    |
| 📦  | 1ud     |

|        |     |   |
|--------|-----|---|
|        | 💡   | ⊙ |
| 563291 | LED | ■ |

|   |                  |
|---|------------------|
| ↕ | 132cm            |
| 💡 | 240              |
| W | 3,6W             |
| ⊗ | NO Empalmable    |
| 🏠 | Interior Indoors |

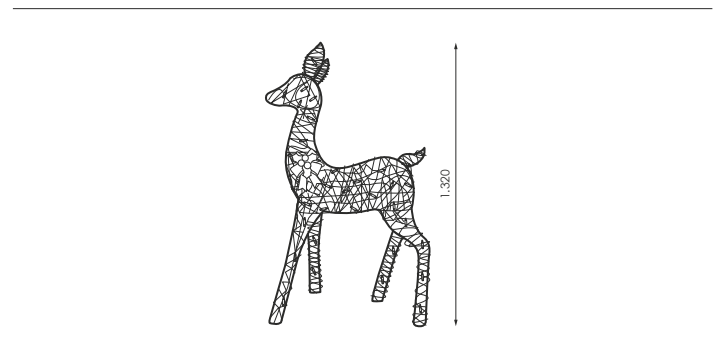

# Elegant Deer

152cm

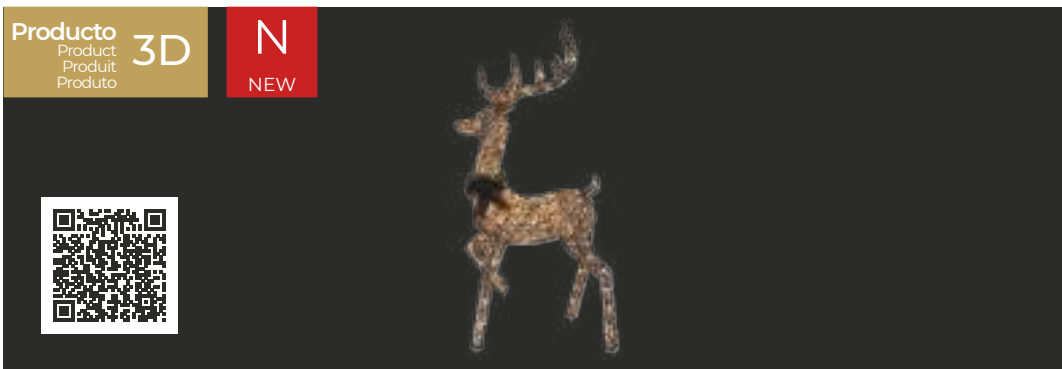

|    |         |
|----|---------|
| ⚡  | 31V     |
| Hz | 50-60Hz |
| ◇  | CIII    |
| ⊙  | IP44    |
| TR | INC.    |
| 📦  | 1ud     |

|        |     |   |
|--------|-----|---|
|        | 💡   | ⊙ |
| 632775 | LED | ■ |

|   |                  |
|---|------------------|
| ↕ | 152cm            |
| 💡 | 150              |
| W | 6W               |
| ⊗ | NO Empalmable    |
| 🏠 | Interior Indoors |

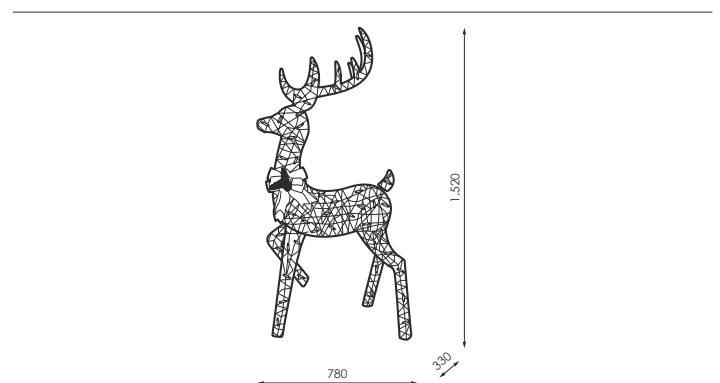

# Elegant Deer Set

⚡ 31V

Hz 50-60Hz

⬡ CIII

⊙ IP44

⊞ INC.

⊞ 1ud

N  
NEW

3D  
Producto  
Produit  
Prodotu

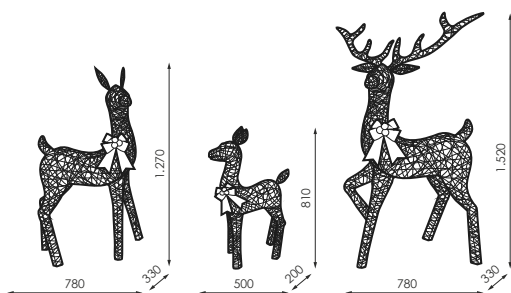

↕ Ver gráfico

☀ 150/120/70

W 7,2W

⊞ NO  
Empalmable

🏠 Interior  
Indoors

||||| ⚡ ⊞

632843

LED

⊞

# Elegant Gift



Producto  
Product  
Produit  
Produto

3D

|    |         |
|----|---------|
| ⚡  | 31V     |
| Hz | 50-60Hz |
| ◇  | CIII    |
| ⊙  | IP44    |
| TR | INC.    |
| 📦  | 1ud     |

|        |     |   |
|--------|-----|---|
|        | 💡   | ⊙ |
| 547802 | LED | ■ |

|   |                  |
|---|------------------|
| 💡 | 10/20/35         |
| W | 3,6W             |
| ✂ | NO Empalmable    |
| 🏠 | Interior Indoors |

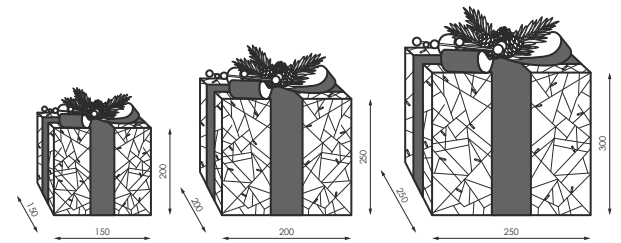

# Elegant Box

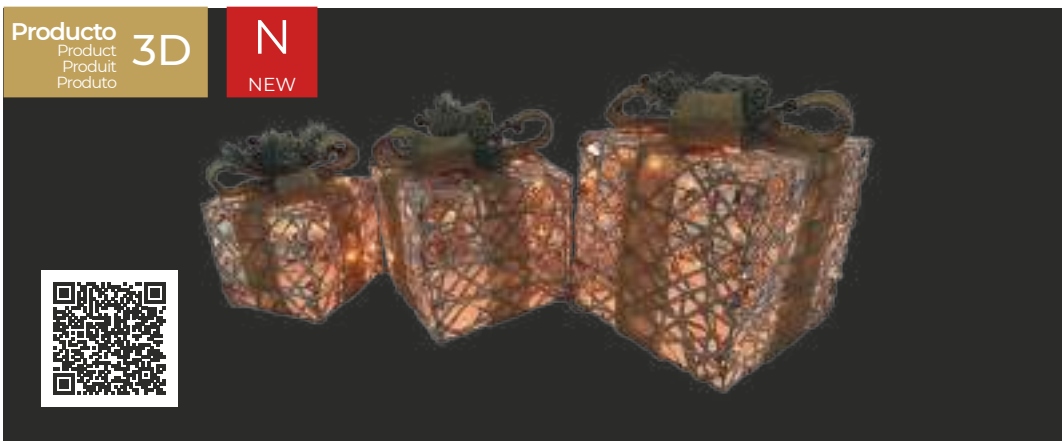

Producto  
Product  
Produit  
Produto

3D

**N**  
NEW

|    |         |
|----|---------|
| ⚡  | 31V     |
| Hz | 50-60Hz |
| ◇  | CIII    |
| ⊙  | IP44    |
| TR | INC.    |
| 📦  | 1ud     |

|        |     |   |
|--------|-----|---|
|        | 💡   | ⊙ |
| 632836 | LED | ■ |



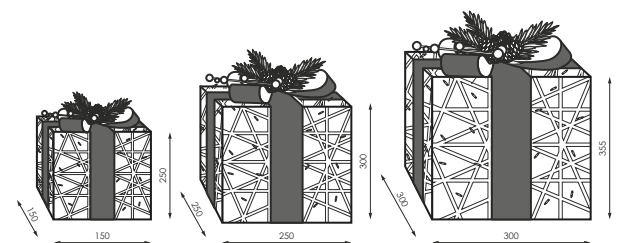

|   |                  |
|---|------------------|
| 💡 | 70               |
| W | 3,6W             |
| ✂ | NO Empalmable    |
| 🏠 | Interior Indoors |











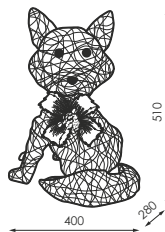
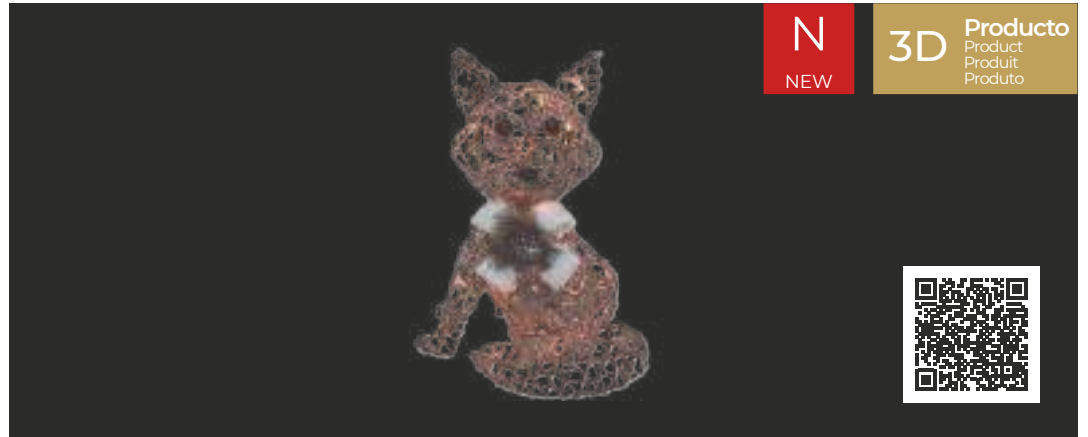



# Elegant Fox

50cm

|   |         |
|---|---------|
|  | 31V     |
| <b>Hz</b>   | 50-60Hz |
|  | CIII    |
|  | IP44    |
|  | INC.    |
|  | 1ud     |







|  |                  |
|--|------------------|
|   | 50cm             |
|   | 35               |
| <b>W</b>   | 3,6W             |
|   | NO Empalmable    |
|  | Interior Indoors |





|   |   |   |
|---|---|---|
|  |  |  |
| 632805  |  |  |



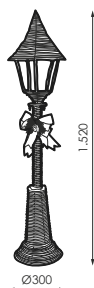

# Farol

152cm

|   |         |
|---|---------|
|  | 31V     |
| <b>Hz</b>   | 50-60Hz |
|  | CIII    |
|  | IP44    |
|  | INC.    |
|  | 1ud     |



|   |                  |
|---|------------------|
|  | 132cm            |
|  | 100              |
| <b>W</b>  | 3,6W             |
|  | NO Empalmable    |
|  | Interior Indoors |

|   |   |   |
|---|---|---|
|  |  |  |
| 632942  |  |  |

# Glaciar Deer

152cm

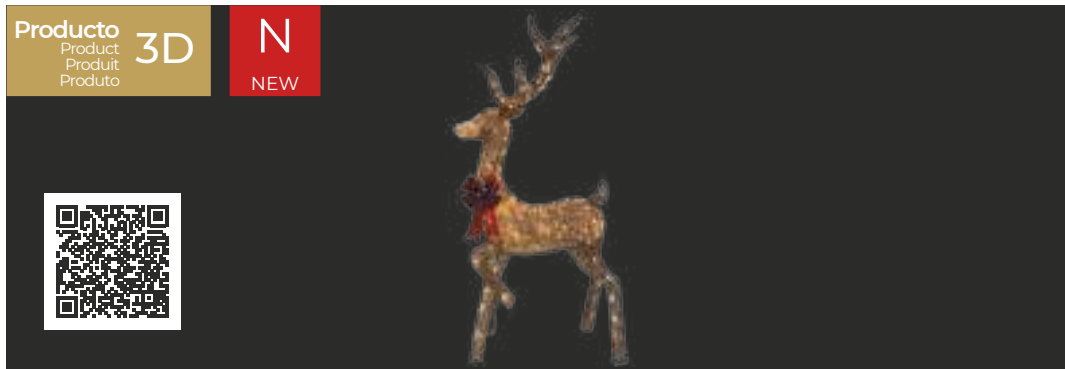

Producto  
Product  
Produit  
Produto

3D

N

NEW



⚡ 31V

Hz 50-60Hz

◇ CIII

⊙ IP44

TR INC.

⊕ 1ud

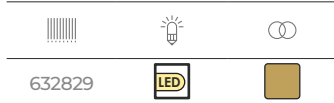

632829



↕ 152cm

☀ 150

W 6W

⊗ NO Empalmable

🏠 Interior Indoors



# Glaciar Deer

183cm

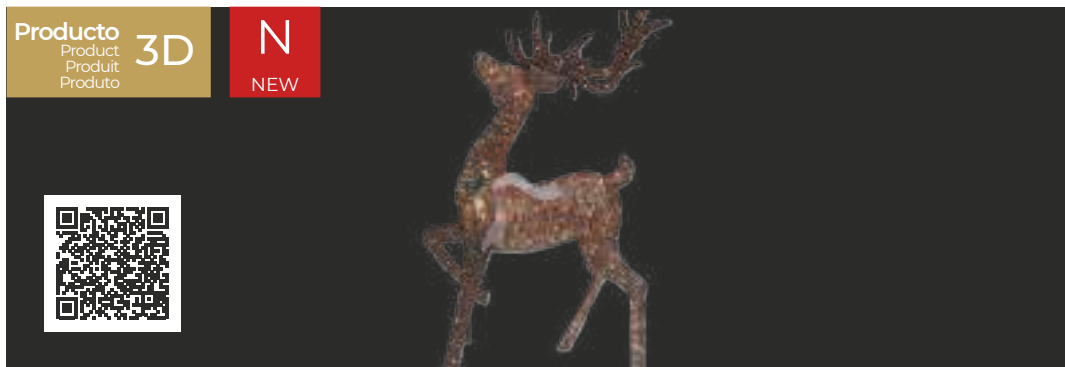

Producto  
Product  
Produit  
Produto

3D

N

NEW



⚡ 31V

Hz 50-60Hz

◇ CIII

⊙ IP44

TR INC.

⊕ 1ud

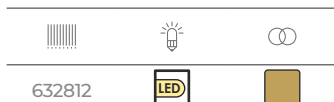

632812



↕ 183cm

☀ 180

W 6W

⊗ NO Empalmable

🏠 Interior Indoors

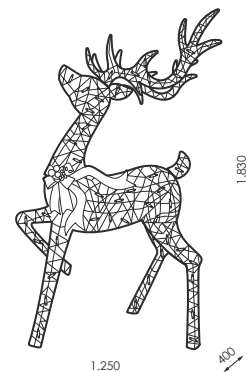

# Glaciar Deer Set

|    |         |
|----|---------|
| ⚡  | 31V     |
| Hz | 50-60Hz |
| ⬠  | CIII    |
| ⊙  | IP44    |
| TR | INC.    |
| ⊠  | 1ud     |

**3D** Producto  
Product  
Produit  
Produto



**La Almazara**  
Ayto. Illescas, Toledo



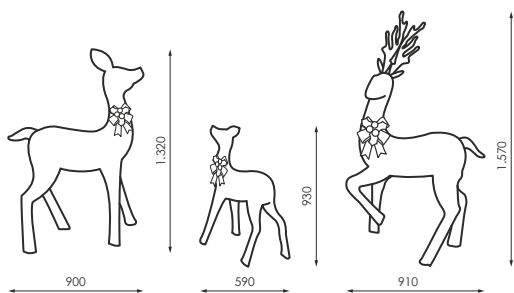

[GRÁFICOS: Unidades en mm/ GRAPHICS: Units in mm/GRAPHIQUES: Unités en mm/GRÁFICOS: Unidades em mm]



|    |                  |        |     |   |
|----|------------------|--------|-----|---|
| ↕  | Ver gráfico      |        | 💡   | ⊙ |
| ☀️ | 150/120/80       | 507097 | LED | □ |
| W  | 12W              |        |     |   |
| ⊗  | NO<br>Empalmable |        |     |   |







# Christmas Balls

|  |  |  |  |
|---|---|---|---|
|   | Ø10cm   | 3/96  | 543620  |
|   | Ø15cm   | 4/24  | 543804  |
|   | Ø20cm   | 1/12  | 543989  |

Azul Glitter  
Blue Glitter  
Bleu Glitter  
Azul Glitter

|  |  |  |  |
|--|---|---|---|
|   | Ø10cm   | 3/96  | 543613  |





Verde Glitter  
Green Glitter  
Vert Glitter  
Verde Glitter

|  |  |  |  |
|---|---|---|---|
|   | Ø10cm   | 3/96  | 972574  |
|   | Ø12cm   | 144   | 972635  |
|   | Ø15cm   | 4/24  | 972697  |
|   | Ø20cm   | 1/12  | 972758  |





Azul Brillo  
Blue Shiny  
Bleu Brillier  
Azul Brilho

|  |  |  |  |
|--|---|---|---|
|   | Ø10cm   | 3/96  | 979238  |





Verde Brillo  
Green Shiny  
Vert Brillier  
Verde Brilho

|  |  |  |  |
|---|---|---|---|
|  | Ø7cm  | 10/240  | 410878  |
|   | Ø15cm   | 4/24  | 411097  |
|   | Ø20cm   | 1/12  | 411127  |

Azul Mate  
Blue Matt  
Bleu Mat  
Azul Matt

|  |  |  |  |
|--|---|---|---|
|  | Ø10cm   | 3/96  | 998093  |
|  | Ø15cm   | 4/24  | 998109  |
|  | Ø20cm   | 1/12  | 998116  |

Verde Mate  
Green Matt  
Vert Mat  
Verde Matt

|  |  |  |  |
|---|---|---|---|
|   | Ø7cm  | 10/240  | 543415  |
|   | Ø10cm   | 3/96  | 543590  |
|   | Ø15cm   | 4/24  | 543774  |
|   | Ø20cm   | 1/12  | 543958  |





Plata Glitter  
Silver Glitter  
Argent Glitter  
Prata Glitter

|  |  |  |  |
|--|---|---|---|
|   | Ø10cm   | 3/96  | 543682  |
|  | Ø15cm   | 4/24  | 543866  |
|  | Ø20cm   | 1/12  | 544047  |





Cobre Glitter  
Copper Glitter  
Cuivre Glitter  
Cobre Glitter

|  |  |  |  |
|---|---|---|---|
|   | Ø7cm  | 10/240  | 972482  |
|   | Ø10cm   | 3/96  | 972543  |
|   | Ø15cm   | 4/24  | 972666  |





Plata Brillo  
Silver Shiny  
Argent Brillier  
Prata Brilho

|  |  |  |  |
|--|---|---|---|
|   | Ø10cm   | 3/96  | 543668  |
|  | Ø15cm   | 4/24  | 543842  |
|  | Ø20cm   | 1/12  | 544023  |

Cobre Brillo  
Copper Shiny  
Cuivre Brillier  
Cobre Brilho

|  |  |  |  |
|---|---|---|---|
|   | Ø7cm  | 10/240  | 410915  |
|   | Ø10cm   | 3/96  | 411042  |
|   | Ø15cm   | 4/24  | 411103  |

Plata Mate  
Silver Matt  
Argent Mat  
Prata Matt

|  |  |  |  |
|--|---|---|---|
|   | Ø7cm  | 10/240  | 543491  |
|  | Ø10cm   | 3/96  | 543675  |
|  | Ø15cm   | 4/24  | 543859  |
|  | Ø20cm   | 1/12  | 544030  |





Cobre Mate  
Copper Matt  
Cuivre Mat  
Cobre Matt

# Christmas Balls

|  |  |  |  |        |
|---|---|---|---|--------|
|   | Blanco Glitter<br>White Glitter<br>Blanc Glitter<br>Branco Glitter                | Ø20cm   | 1/12  | 544115 |

|  |  |  |  |        |
|--|---|---|---|--------|
|   | Negro Glitter<br>Black Glitter<br>Noir Glitter<br>Preto Glitter                     | Ø10cm   | 3/96  | 543736 |
|  |   | Ø15cm   | 4/24  | 543910 |
|  |   | Ø20cm   | 1/12  | 544092 |

|  |  |  |  |        |
|---|---|---|---|--------|
|   | Blanco Brillo<br>White Shiny<br>Blanc Brillor<br>Branco Brilho                    | Ø15cm   | 4/24  | 543927 |
|   |   | Ø20cm   | 1/12  | 544108 |





|  |  |  |  |        |
|--|---|---|---|--------|
|   | Negro Mate<br>Black Matt<br>Noir Mat<br>Preto Matt                                  | Ø7cm  | 10/240  | 543545 |
|  |   | Ø10cm   | 3/96  | 543729 |
|  |   | Ø15cm   | 4/24  | 543903 |
|  |   | Ø20cm   | 1/12  | 544085 |





|  |  |  |  |        |
|---|---|---|---|--------|
|  | Granate Glitter<br>Garnet Glitter<br>Grenat Glitter<br>Granada Glitter            | Ø7cm  | 10/240  | 543422 |
|   |   | Ø10cm   | 3/96  | 543606 |

|  |  |  |  |        |
|--|---|---|---|--------|
|  | Oro Glitter<br>Gold Glitter<br>Or Glitter<br>Ouro Glitter                           | Ø7cm  | 10/240  | 543408 |

|  |  |  |  |        |
|---|---|---|---|--------|
|   | Granate Brillo<br>Garnet Shiny<br>Grenat Brillor<br>Granada Brilho                  | Ø7cm  | 10/240  | 972499 |
|   |   | Ø10cm   | 3/96  | 972550 |
|   |   | Ø15cm   | 4/24  | 972673 |
|   |   | Ø20cm   | 1/12  | 972734 |
|   |   | Ø30cm   | 4   | 972826 |
|   |   | Ø50cm   | 1   | 384711 |

|  |  |  |  |        |
|--|---|---|---|--------|
|   | Oro Brillo<br>Gold Shiny<br>Or Brillor<br>Ouro Brilho                                 | Ø7cm  | 10/240  | 972468 |
|  |   | Ø10cm   | 3/96  | 972529 |
|  |   | Ø15cm   | 4/24  | 972642 |
|  |   | Ø20cm   | 1/12  | 972703 |
|  |   | Ø30cm   | 4   | 972802 |
|  |   | Ø50cm   | 1   | 384728 |

|  |  |  |  |        |
|---|---|---|---|--------|
|   | Granate Mate<br>Garnet Matt<br>Grenat Mat<br>Granada Matt                           | Ø7cm  | 10/240  | 972505 |
|   |   | Ø10cm   | 3/96  | 972567 |
|   |   | Ø15cm   | 4/24  | 972680 |
|   |   | Ø20cm   | 1/12  | 972741 |
|   |   | Ø30cm   | 4   | 972833 |

|  |  |  |  |        |
|--|---|---|---|--------|
|   | Oro Mate<br>Gold Matt<br>Or Mat<br>Ouro Matt  | Ø7cm  | 10/240  | 972475 |
|  |   | Ø10cm   | 3/96  | 972536 |
|  |   | Ø15cm   | 4/24  | 972659 |
|  |   | Ø20cm   | 1/12  | 972710 |
|  |   | Ø30cm   | 4   | 972819 |

# Christmas Balls



Brasería La Selva  
Barcelona

|  | Marfil Brillo<br>Ivory Shiny<br>Ivoire Brillant<br>Marfim Brilho | Ø20cm | 1/12 | 193108 |
|--|--|-------|------|--------|

|  | Rosa Glitter                 | Ø10cm | 3/96 | 543651 |
|--|------------------------------|-------|------|--------|
|  | Pink Glitter                 | Ø15cm | 4/24 | 543835 |
|  | Rose Glitter<br>Rosa Glitter | Ø20cm | 1/12 | 544016 |

|  | Rosa Brillo                  | Ø10cm | 3/96 | 543637 |
|--|------------------------------|-------|------|--------|
|  | Pink Shiny                   | Ø15cm | 4/24 | 543811 |
|  | Rose Brillant<br>Rosa Brilho | Ø20cm | 1/12 | 543996 |

|  | Rosa Mate             | Ø10cm | 3/96 | 543644 |
|--|-----------------------|-------|------|--------|
|  | Pink Matt             | Ø15cm | 4/24 | 543828 |
|  | Rose Mat<br>Rosa Matt | Ø20cm | 1/12 | 544009 |

|  | Olive Glitter                  | Ø10cm | 3/96 | 543712 |
|--|--------------------------------|-------|------|--------|
|  | Olive Glitter                  | Ø15cm | 4/24 | 543897 |
|  | Olive Glitter<br>Olive Glitter | Ø20cm | 1/12 | 544078 |

|  | Olive Brillo                   | Ø10cm | 3/96 | 543699 |
|--|--------------------------------|-------|------|--------|
|  | Olive Shiny                    | Ø15cm | 4/24 | 543873 |
|  | Olive Brillant<br>Olive Brilho | Ø20cm | 1/12 | 544054 |

|  | Olive Mate              | Ø10cm | 3/96 | 543705 |
|--|-------------------------|-------|------|--------|
|  | Olive Matt              | Ø15cm | 4/24 | 543880 |
|  | Olive Mat<br>Olive Matt | Ø20cm | 1/12 | 544061 |



# Cluster Balls

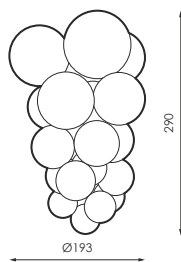

29x19,3cm



1ud



210799



411134



411141



411158

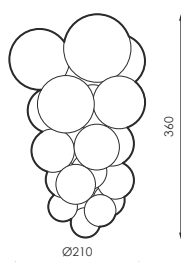

36x21cm



1ud



411172



411189



411196



# Branch

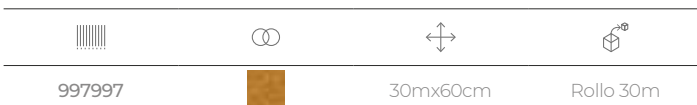

## Información/Information/Information/Informações

**Ñ**/ Ideal para árboles, conos gigantes y decoración de pasillos y fachadas.

**E**/ Ideal for trees, giant cones and decoration of halls and facades.

**F**/ Idéal pour les arbres, les cônes géants et décoration de salles et façades.

**P**/ Ideal para árvores, conos gigantes e decoração de paredes e fachadas.

# Tapiz Metalizado

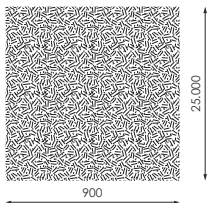
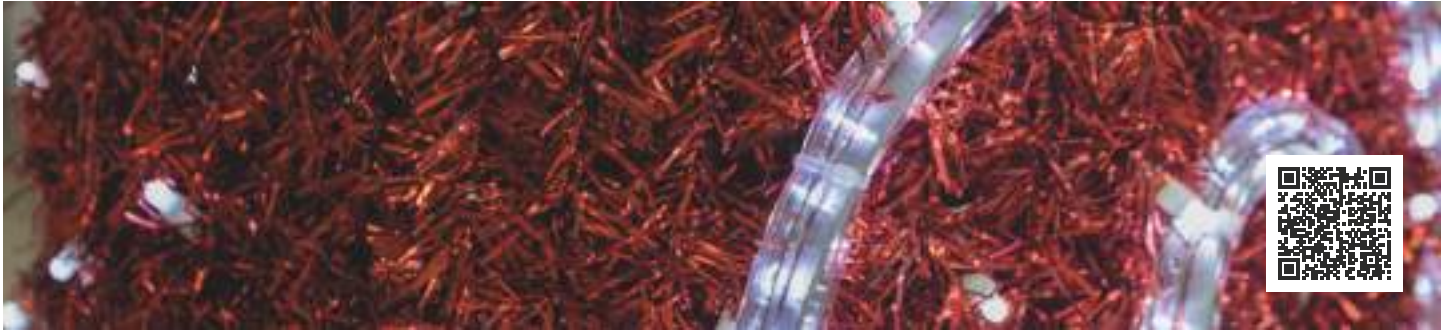

↕ 2500x90cm

📦 Rollo 25m



|        |  |   |
|--------|--|---|
| 093712 |  | Azul/Blue/Bleu/Azul                       |
| 093705 |  | Verde/Green/ Vert/ Verde                  |
| 093651 |  | Rojo/Red/Rouge/Vermelha                   |
| 093675 |  | Oro claro/Clear gold/Or clair/Limpar ouro |
| 093743 |  | Plata/Silver/Argent/Prata                 |
| 093736 |  | Negro/Black/Noir/Preto                    |
| 962018 |  | Blanco/White/Blanc/Branca                 |

# Tapiz Tradicional

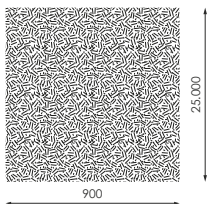

↕ 2500x90cm

📦 Rollo 25m



|        |  |                                |
|--------|--|--------------------------------|
| 061414 |  | Verde/Green/ Vert/ Verde       |
| 061421 |  | Blanco/White/Blanc/Branca      |
| 061438 |  | Amarillo/Yellow/Jaune/Amarela  |
| 061445 |  | Rojo/Red/Rouge/Vermelha        |
| 061452 |  | Azul/Blue/Bleu/Azul            |
| 086110 |  | Marrón/Brown/Brun/Marrom       |
| 086127 |  | Naranja/Orange/Orange/Laranaja |
| 952842 |  | Rosa/Pink/Rose/Rosa            |

Aviso/Warning/Avertissement/Aviso

Ñ/ NO APTO para lugares con alta concentración de niebla salina tales como zonas costeras, puertos marítimos o puertos.  
NO cubierto por la garantía bajo dichas circunstancias.

E/ NOT SUITABLE for areas with a high concentration of salt spray such as foreshores and harbours.  
NOT warranty under such circumstances.

F/ NE CONVIENT PAS pour les régions avec une forte concentration de brouillard salin tels que les estrans et les ports.  
PAS couvert par la garantie dans de telles circonstances.

P/ NÃO APROPRIADO para áreas com alta concentração de névoa salina, como costas e portos.  
NÃO cobertos pela garantia sob tais circunstâncias.



# Garland



| Barcode | Color  | Description   |
|---------|--------|---|
| 486583  | Gold   | Dorado metálico/Gold metallic/<br>Or métallique/Ouro metálico       |
| 486590  | Silver | Plata metálico/Silver metallic/<br>Argent métallique/Prata metálico |
| 486545  | Red    | Rojo metálico/Red metallic/<br>Rouge métallique/Vermelho metálico   |
| 486576  | Blue   | Azul metálico/Blue metallic/<br>Bleu métallique/Azul metálico       |
| 486606  | Green  | Verde mate/Green matt/<br>Vert mat/Verde mate                       |

|            |
|------------|
| Ø8x1.000cm |
| Rollo 10m  |

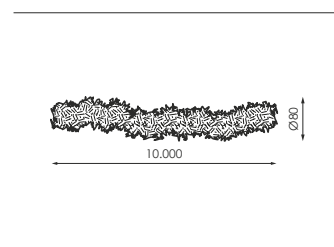

| Barcode | Color  | Description   |
|---------|--------|---|
| 486644  | Gold   | Dorado metálico/Gold metallic/<br>Or métallique/Ouro metálico       |
| 486651  | Silver | Plata metálico/Silver metallic/<br>Argent métallique/Prata metálico |
| 486613  | Red    | Rojo metálico/Red metallic/<br>Rouge métallique/Vermelho metálico   |
| 486637  | Blue   | Azul metálico/Blue metallic/<br>Bleu métallique/Azul metálico       |
| 486668  | Green  | Verde mate/Green matt/<br>Vert mat/Verde mate                       |

|             |
|-------------|
| Ø12x1.000cm |
| Rollo 10m   |

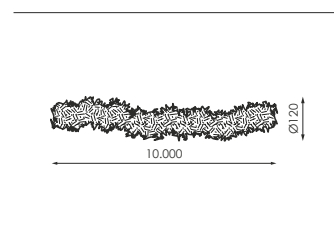



# Holly Garland

N  
NEW

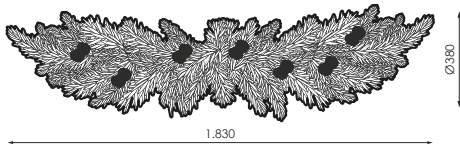

Ø380x1.830mm



6uds

632850

# Pine Garland

N  
NEW



Ø355x1.830mm



6uds

632867

# Green Branch



CC. Gran Casa  
Zaragoza



507042



3.000x45cm



Rollo 3m

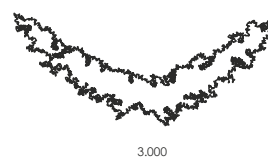

# Tapiz Net



484206



Dorado metálico/Gold metallic/  
Or métallique/Ouro metálico

484213



Plata metálico/Silver metallic/  
Argent métallique/Prata metálico

484220



Rojo metálico/Red metallic/  
Rouge métallique/Vermelho metálico

484237



Verde metálico/Green metallic/  
Vert métallique/Verde metálico

484244



Azul metálico/Blue metallic/  
Bleu métallique/Azul metálico

484251



Verde mate/Green matt/  
Vert mat/Verde mate



2500x90cm



Rollo 25m

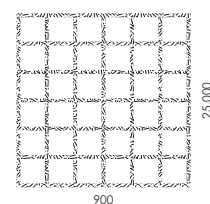

# PVC Net

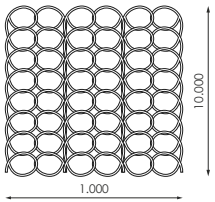
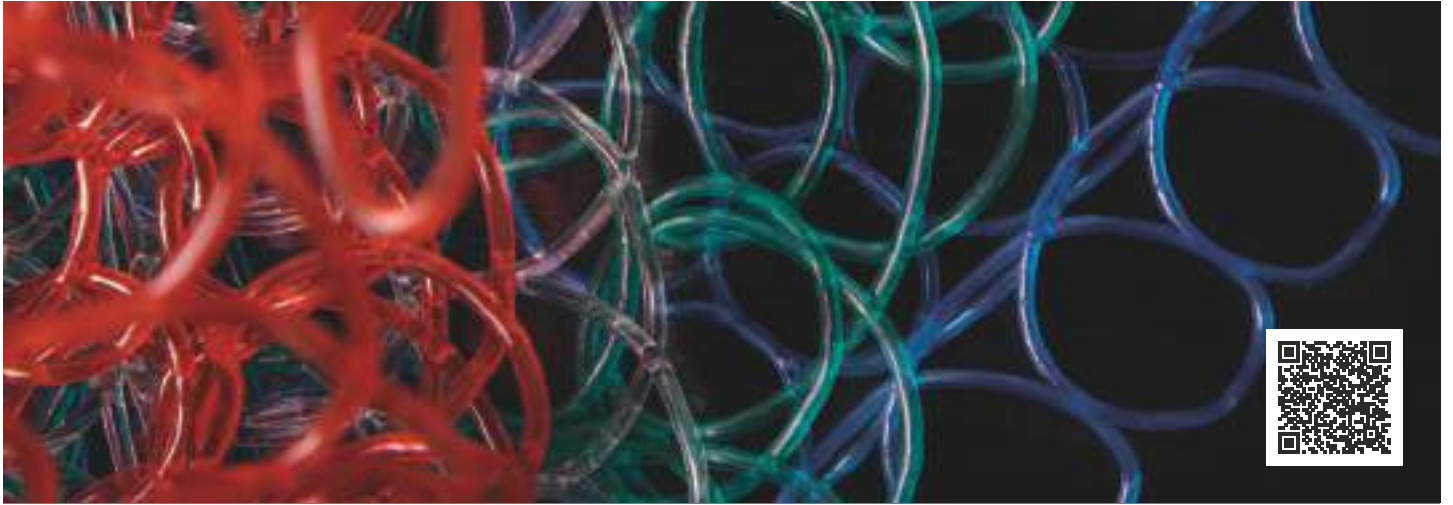

10x1m



Rollo 10m



442848

Transparente/Transparent/Transparent/Transparente

442855

Rojo/Red/Rouge/Vermelho

442862

Azul/Blue/Bleu/Azul

442879

Verde/Green/Vert/Verde

# PVC Net Glitter

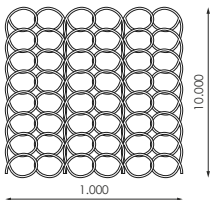
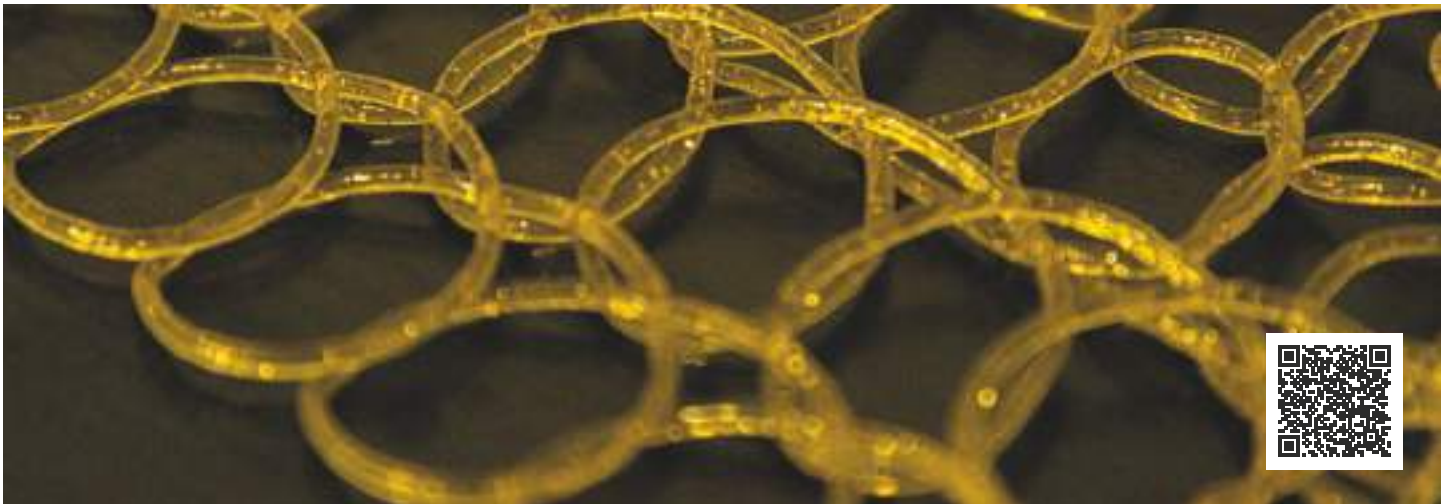

10x1m



Rollo 10m



442886

Dorado/Golden/D'or/Dourado

442893

Plata/Silver/Argent/Prata



# Fall Lite *LED*

Smart



⚡ 230V ac

Hz 50-60Hz

□ CII

⊙ IP44

⊗ NO INC.

⊞ 60ud



487498



60cm



144

W

1,5W



100pc

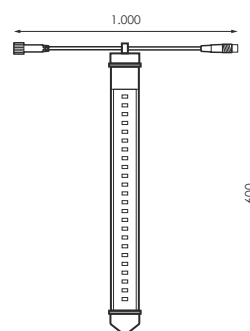

ESQUEMA INSTALACIÓN/  
INSTALLATION SCHEME/  
SCHEMA D'INSTALLATION/  
ESQUEMA DE  
INSTALAÇÃO



+

Producto/Product  
Produit/Produto

## Información/Information/Information/Informações

**N/** Este producto puede utilizar el cable de alimentación con o sin rectificador.

**E/** This product can use the power cord with or without a rectifier.

**F/** Ce produit peut utiliser le cordon d'alimentation avec ou sans redresseur.

**P/** Este produto pode usar o cabo de alimentação com ou sem um retificador.

Accesorios (NO Incluidos) / Accessoires (NOT Included) / Accessories (NON Inclus) / Acessórios (NÃO Incluso)





+ INFO PAG. 506

193078

Cable alimentación Blanco

# Fall Lite *LED*



## Smart



|   |         |
|---|---------|
|  | 230V ac |
| <b>Hz</b>   | 50-60Hz |
|  | CII     |
|  | IP44    |
|  | NO INC. |
|  | 25ud    |

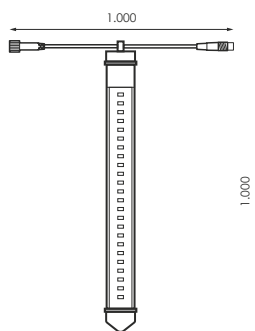

Arcos Valdevez  
Portugal



|   |       |
|---|-------|
|  | 100cm |
|  | 192   |
| <b>W</b>  | 3W    |
|  | 100pc |

|   |   |
|---|---|
|  |  |
| 487504  |  |

ESQUEMA INSTALACIÓN/  
INSTALLATION SCHEME/  
SCHEMA D'INSTALLATION/  
ESQUEMA DE  
INSTALAÇÃO



+

Producto/Product  
Produit/Produto

### Información/Information/Information/Informações

**N/** Este producto puede utilizar el cable de alimentación con o sin rectificador.

**E/** This product can use the power cord with or without a rectifier.

**F/** Ce produit peut utiliser le cordon d'alimentation avec ou sans redresseur.

**P/** Este produto pode usar o cabo de alimentação com ou sem um retificador.

Accesorios (NO Incluidos) / Accessoires (NOT Included) / Accessories (NON Inclus) / Acessórios (NÃO Incluso)

+ INFO PAG. 506

193078

Cable alimentación Blanco

# Fall Lite *LED*

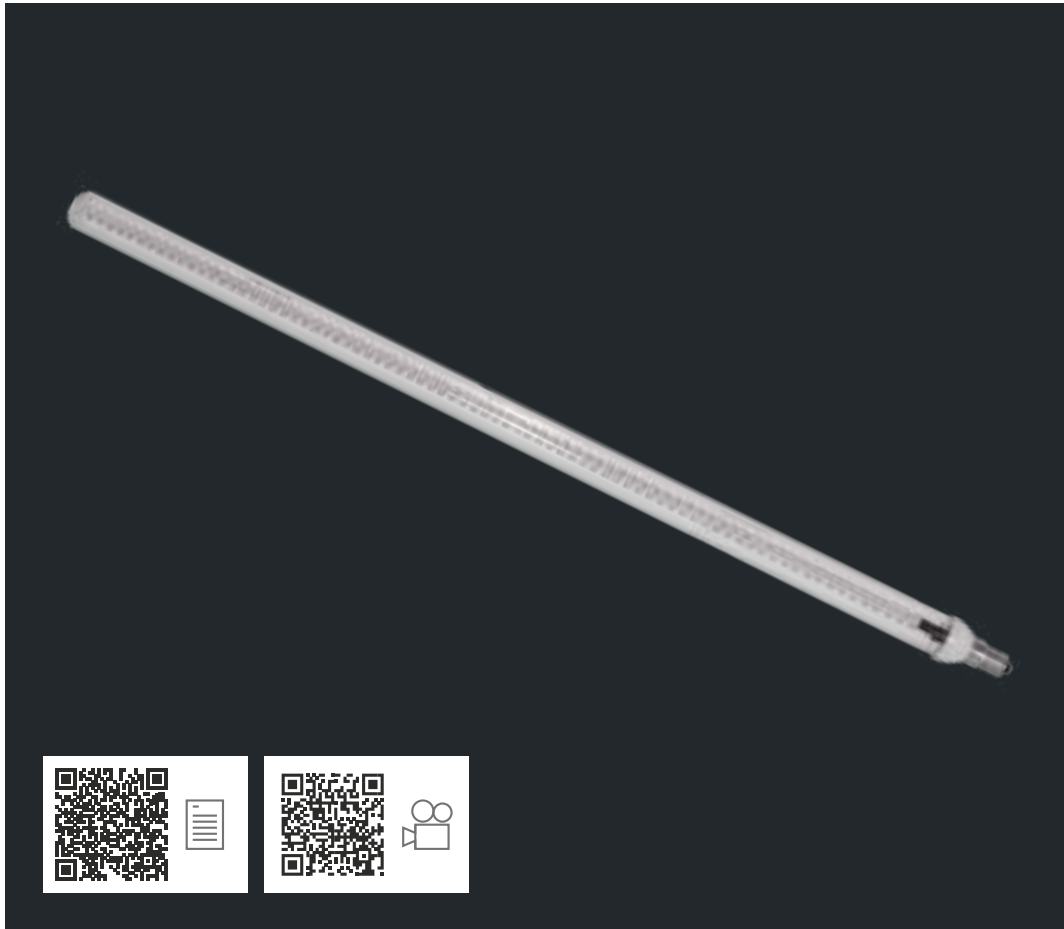

⚡ 230V

Hz 50-60Hz

°° IP44

📦 10ud

Ñ/ Para portalámparas estanco. **E/** For waterproof lampholder. **F/** Pour la douille imperméable à l'eau. **P/** Para portalâmpada impermeável.

|        |  |
|--------|--|
|        |  |
| 543040 |  |

|   |      |
|---|------|
| ↔ | 20cm |
| W | 1W   |
|   | E14  |

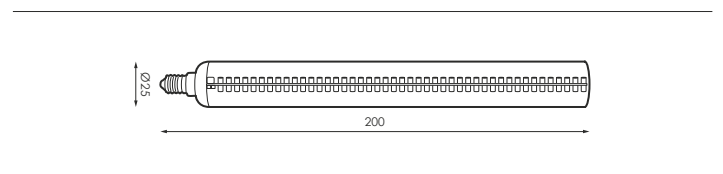

|         |  |
|---------|--|
|         |  |
| 588973* |  |

|   |      |
|---|------|
| ↔ | 22cm |
| W | 3W   |
|   | E14  |

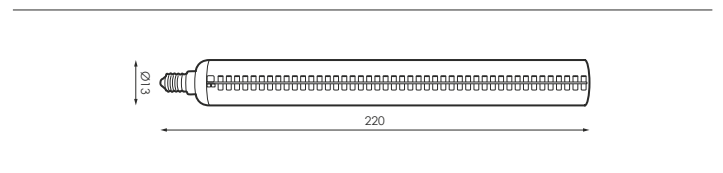

|        |  |
|--------|--|
|        |  |
| 543064 |  |

|   |       |
|---|-------|
| ↔ | 100cm |
| W | 4W    |
|   | E14   |

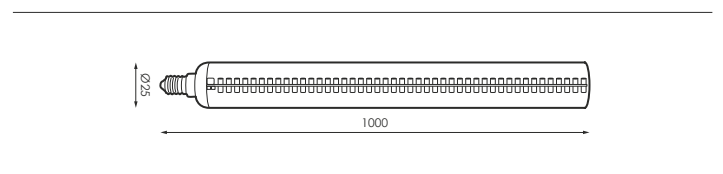

## Información/Information/Information/Informações

Ñ/ \* Este producto lleva LEDs SMD.

E/ \* This product carries SMD LEDs.

F/ \* Ce produit est équipé de LED SMD.

P/ \* Este produto possui LEDs SMD.



# Pebetero *LED*

⚡ 230V ac

Hz 50-60Hz

⊙ IP44

📦 100ud

Ñ/ Para portalámparas estanco. **E/**For waterproof lampholder. **F/** Pour la douille imperméable à l'eau. **P/** Para portalâmpada impermeável.

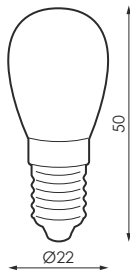

W 1W

E14

Cristal transparente.  
Transparent glass.  
Verre transparent.  
Vidro transparente.



391214 \*

391238 \*



# Pebetero *LED*

⚡ 230V ac

Hz 50-60Hz

⊙ IP44

📦 100ud

Ñ/ Para portalámparas estanco. **E/**For waterproof lampholder. **F/** Pour la douille imperméable à l'eau. **P/** Para portalâmpada impermeável.

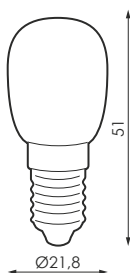

W 1,5W

E14

Cristal transparente.  
Transparent glass.  
Verre transparent.  
Vidro transparente.



561174

561181

561198

561204

561211

563710



# esSENSE BALL *LED*



⚡ 230V ac

Hz 50-60Hz

°° IP44

⊞ 100ud

**Ñ**/ Para portalámparas estanco. **E**/For waterproof lampholder. **F**/ Pour la douille imperméable à l'eau. **P**/ Para portalâmpada impermeável.

| Barcode | Light Bulb Icon |
|---------|-----------------|
| 561235  | LED             |
| 561228  | LED             |
| 590761  | LED             |
| 590754  | LED             |
| 590785  | LED             |
| 590778  | LED             |

|   |      |
|---|------|
| W | 1,6W |
| ⊞ | E27  |

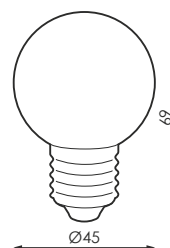

# esSENSE Ball *LED* basic



⚡ 230V

Hz 50-60Hz

°° IP44

⊞ 10/100

**Ñ**/ Para portalámparas estanco. **E**/For waterproof lampholder. **F**/ Pour la douille imperméable à l'eau. **P**/ Para portalâmpada impermeável.

| Barcode | Light Bulb Icon |
|---------|-----------------|
| 961240* | LED             |

|   |      |
|---|------|
| W | 1,5W |
| ⊞ | E27  |

\*Cambio de color sincronizado entre lámparas.  
\*Change of color sync between lamps.  
\*Changement de synchronisation de couleur entre les lampes.  
\*Mudança de sincronização de cor entre lâmpadas.

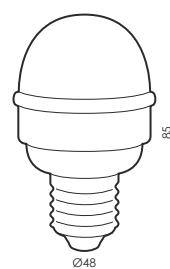

# Flash Light *LED*

⚡ 230V

Hz 50-60Hz

⊙ ⊙ IP44

🔒 100ud

Ñ/ Para portalámparas estanco. **E/**For waterproof lampholder. **F/** Pour la douille imperméable à l'eau. **P/** Para portalâmpada impermeável.

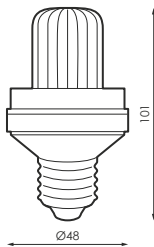

W 3W

💡 36



389884

LED

E14

389907

LED

E27

389891

LED

E22

# Standard Incandescencia

⚡ 230V ac

Hz 50-60Hz

⊙ ⊙ IP44

🔒 100ud

Ñ/ Para portalámparas estanco. **E/**For waterproof lampholder. **F/** Pour la douille imperméable à l'eau. **P/** Para portalâmpada impermeável.

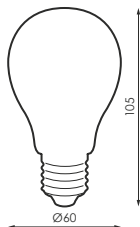

W 15W

🔒 E27



012652\*



# String Flash



|           |              |
|-----------|--------------|
|           | 230V dc      |
| <b>Hz</b> | 50-60Hz      |
|           | CII          |
|           | IP44         |
|           | -20°C~+60 °C |
|           | NO INC.      |
|           | 20ud         |

|        |  |  |
|--------|--|--|
|        |  |  |
| 146579 |  |  |
| 146586 |  |  |

|          |        |
|----------|--------|
|          | 3m     |
|          | 3      |
| <b>W</b> | 2,4W   |
|          | 10sets |

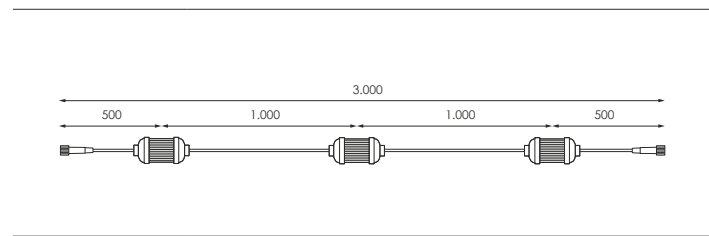

ESQUEMA INSTALACIÓN/  
 INSTALLATION SCHEME/  
 SCHEMA D'INSTALLATION/  
 ESQUEMA DE  
 INSTALAÇÃO

+ Producto/Product  
Produit/Produto

Accesorios (NO Incluidos) / Accessoires (NOT Included) / Accessories (NON Inclus) / Acessórios (NÃO Includo)  
 + INFO PAG. 506

995092  
 Cable alimentación Negro

977722  
 Cable alimentación Blanco



Prilux eConcept

PRILUX  
eConcept

Iluminación Decorativa  
BODAS - EVENTOS - TERRAZAS



*Comparte tus Momentos Deluxe*



+info



# Stalactite Garland

E27



⚡ 230V

Hz 50-60Hz

☐ CII

☉ IP44

✗ NO INC.

♻️ 1ud



|        |   |
|--------|---|
|        | ∞ |
| 600057 |   |

|   |             |
|---|-------------|
| ↔ | 100m        |
| W | Máx. 3.105W |
|   | Máx. 13,5A  |

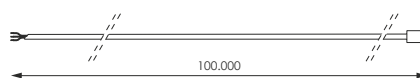

## Accesorios (NO Incluidos) / Accessoires (NOT Included) / Accessories (NON Inclus)/ Acessórios (NÃO Incluso)

|        |   |
|--------|---|
|        | ∞ |
| 600088 |   |

|   |          |
|---|----------|
| ↔ | 25,5cm   |
|   | Máx. 15W |
|   | E27      |

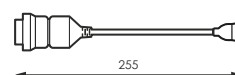



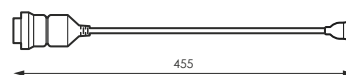

|        |   |
|--------|---|
|        | ∞ |
| 600095 |   |

|   |          |
|---|----------|
| ↔ | 45,5cm   |
|   | Máx. 15W |
|   | E27      |





# Stalactite Garland

E27

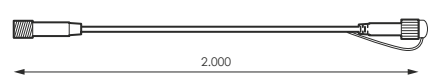

|   |         |
|---|---------|
|  | 230V    |
| <b>Hz</b>   | 50-60Hz |
|  | CII     |
|  | IP44    |
|  | NO INC. |
|  | Tud     |

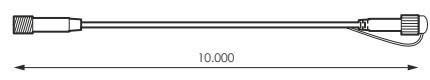

|   |             |
|---|-------------|
|  | 2m          |
| <b>W</b>  | Máx. 3.105W |
|  | Máx. 13,5A  |

|   |   |
|---|---|
|  |  |
| 600064  |  |





|   |             |
|---|-------------|
|  | 10m         |
| <b>W</b>  | Máx. 3.105W |
|  | Máx. 13,5A  |

|   |   |
|---|---|
|  |  |
| 600071  |  |

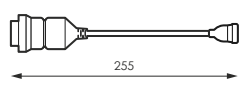

## Accesorios (NO Incluidos) / Accessoires (NOT Included) / Accessories (NON Inclus) / Acessórios (NÃO Incluso)



|   |          |
|---|----------|
|  | 25,5cm   |
|  | Máx. 15W |
|  | E27      |

|   |   |
|---|---|
|  |  |
| 600088  |  |



|   |          |
|---|----------|
|  | 45,5cm   |
|  | Máx. 15W |
|  | E27      |

|   |   |
|---|---|
|  |  |
| 600095  |  |

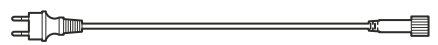

|   |   |
|---|---|
|    | 2m  |
|  |  |
| 600101  |  |

[GRÁFICOS: Unidades en mm/ GRAPHICS: Units in mm/ GRAPHIQUES: Unités en mm/ GRÁFICOS: Unidades em mm]



# Guirnalda E14



⚡ 230V dc

Hz 50-60Hz

☐ CII

⊙ IP44

⚗ INC.

⊞ 1ud



La Matanza de Acentejos  
Tenerife



392105



15m



20W



60

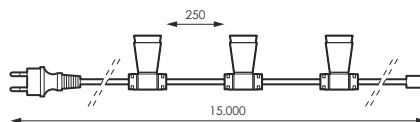

392112



50m



5W



200

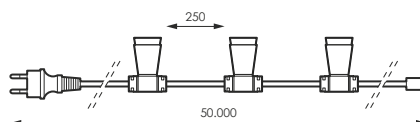



# Guirnalda E27

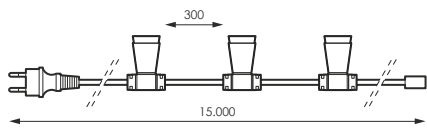

↔ 15m



W/ 20W

392075



45

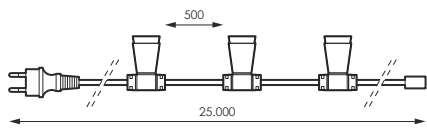

↔ 25m



W/ 20W

446433



50

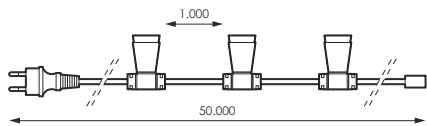

↔ 50m



W/ 20W

446440



50

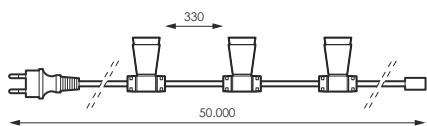

↔ 50m



W/ 5W

392082



150

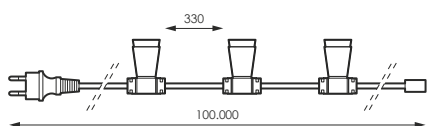

↔ 100m



W/ 2W

392099





300

# Accesorios (NO Incluidos)

Accessoires (NOT Included)

Accessories (NON Inclus)

Acessórios (NÃO Incluso)

|   |        | Cluster Shop<br><i>Microled</i> | ICICLE#<br><i>Microled</i> | <i>Led</i><br>Fireworks | Willow Light | <i>Led</i><br>Fountain | Fall Lite <i>Led</i><br>Smart | Snowlite <i>Led</i> | String Flash | Smart<br>20 Light | Fall Lite <i>Led</i> | Essense <i>Led</i> | Pebetero <i>Led</i> | Flash Light <i>Led</i> |
|---|--------|---------------------------------|----------------------------|-------------------------|--------------|------------------------|-------------------------------|---------------------|--------------|-------------------|----------------------|--------------------|---------------------|------------------------|
|    | 149181 |                                 |                            | •                       |              |                        |                               |                     |              |                   |                      |                    |                     |                        |
|   | 149198 |                                 |                            | •                       |              |                        |                               |                     |              |                   |                      |                    |                     |                        |
|   | 149204 |                                 |                            | •                       |              |                        |                               |                     |              |                   |                      |                    |                     |                        |
|   | 149211 |                                 |                            | •                       |              |                        |                               |                     |              |                   |                      |                    |                     |                        |
|   | 193061 |                                 |                            |                         |              |                        | •                             |                     |              | •                 |                      |                    |                     |                        |
|   | 193078 |                                 |                            |                         |              |                        | •                             | •                   |              | •                 |                      |                    |                     |                        |
|   | 977722 |                                 |                            |                         |              |                        | •                             |                     | •            |                   |                      |                    |                     |                        |
|   | 995092 |                                 |                            |                         |              |                        | •                             |                     | •            |                   |                      |                    |                     |                        |
|  | 146623 |                                 |                            |                         |              |                        |                               |                     |              |                   |                      | •                  |                     | •                      |
|   | 192316 |                                 |                            |                         |              |                        |                               |                     |              |                   |                      | •                  |                     | •                      |
|   | 391511 |                                 |                            |                         |              |                        |                               |                     |              |                   | •                    |                    | •                   | •                      |
|   | 391528 |                                 |                            |                         |              |                        |                               |                     |              |                   | •                    |                    | •                   | •                      |
|   | 447720 |                                 | •                          |                         |              |                        |                               |                     |              |                   |                      |                    | •                   | •                      |
|  | 401371 |                                 |                            |                         |              | •                      |                               |                     |              |                   |                      |                    |                     |                        |
|   | 401388 |                                 |                            |                         | •            |                        |                               |                     |              |                   |                      |                    |                     |                        |

SOPORTE PARED WILLOW LIGHT

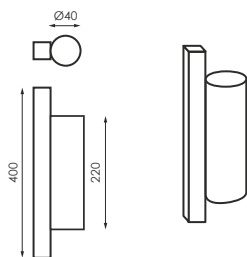

401388



INT.



EXT.

SOPORTE PARED LED FOUNTAIN

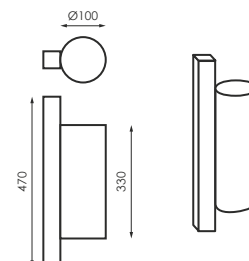

401371



INT.



EXT.

TRANSFORMADOR 24V

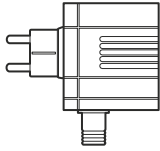

|    |        |            |   |
|----|--------|------------|---|
| TR |        | W          |   |
|    | 149181 | Máx. 10,8W | Sin rectificador<br>Without rectifier<br>Sans redresseur<br>Sem retificador |

TRANSFORMADOR 24V

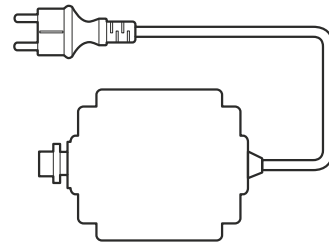

|    |        |            |   |
|----|--------|------------|---|
| TR |        | W          |   |
|    | 149198 | Máx. 28,8W | Sin rectificador<br>Without rectifier<br>Sans redresseur<br>Sem retificador |

TRANSFORMADOR 24V

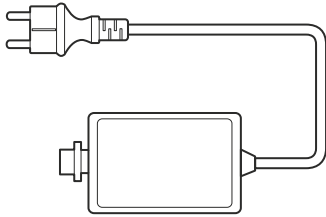

|    |        |          |   |
|----|--------|----------|---|
| TR |        | W        |   |
|    | 149204 | Max. 60W | Sin rectificador<br>Without rectifier<br>Sans redresseur<br>Sem retificador |

TRANSFORMADOR 24V

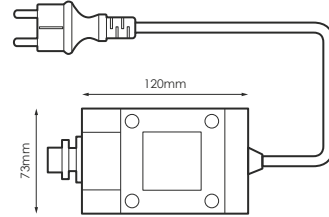

|    |        |           |   |
|----|--------|-----------|---|
| TR |        | W         |   |
|    | 149211 | Max. 120W | Sin rectificador<br>Without rectifier<br>Sans redresseur<br>Sem retificador |

CABLE ALIMENTACIÓN SMART LINK

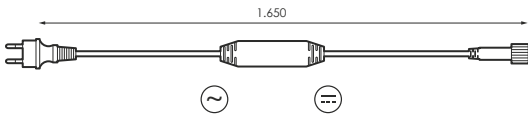

|    |        |        |           |     |                            |   |
|----|--------|--------|-----------|-----|----------------------------|---|
| UR |        | ⊕      | ⚡         | W   | □                          | ⊙ |
|    | 995092 | 230Vac | Max. 480W | CII | IP44 Plug<br>IP65 Conector |   |
|    | 977722 | 230Vac | Max. 480W | CII | IP44 Plug<br>IP65 Conector |   |

CABLE ALIMENTACIÓN SMART LINK

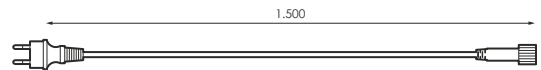

|    |        |        |           |     |                            |   |
|----|--------|--------|-----------|-----|----------------------------|---|
| UR |        | ⊕      | ⚡         | W   | □                          | ⊙ |
|    | 193061 | 230Vac | Max. 480W | CII | IP44 Plug<br>IP65 Conector |   |
|    | 193078 | 230Vac | Max. 480W | CII | IP44 Plug<br>IP65 Conector |   |

SMART E27/E14 SMART LINK

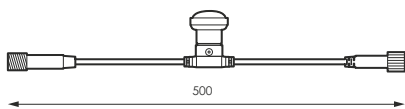

|        |     |   |
|--------|-----|---|
|        | ⊕   | ⊙ |
| 391528 | E14 | ⊙ |
| 391511 | E14 | ⊙ |
| 192316 | E27 | ⊙ |
| 146623 | E27 | ⊙ |

Handwritten notes on a sheet of paper, including a table with multiple columns and rows of illegible text.



Handwritten notes on a sheet of paper, including a table with multiple columns and rows of illegible text.

Handwritten notes on a sheet of paper, including a table with multiple columns and rows of illegible text.





Anexos  
Annexes  
Annexes  
Anexos

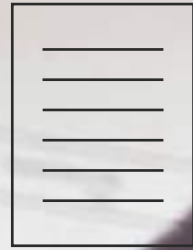

# Reparación tramo Flexilight

Repair of the Flexilight segment

Réparation du segment Flexilight

Reparação do segmento Flexilight

1

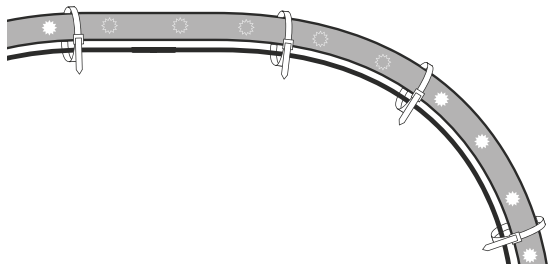

2

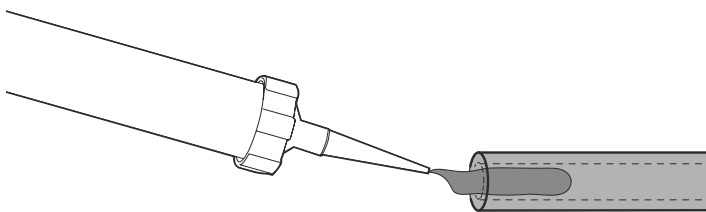

3

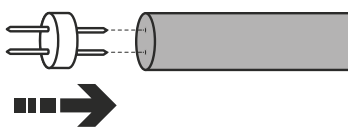

Ñ/ ASEGÚRESE DE QUE LA POLARIDAD Y EL SENTIDO DE LA CORRIENTE SON LOS CORRECTOS.

F/ ASSUREZ-VOUS QUE LA POLARITÉ ET LA DIRECTION DE LA PUISSANCE SONT CORRECT.

E/ MAKE SURE THAT THE POLARITY AND THE POWER DIRECTION ARE CORRECT.

P/ CERTIFIQUE QUE A POLARIDADE E A DIREÇÃO DA CORRENTE SÃO CORRETAS.

4

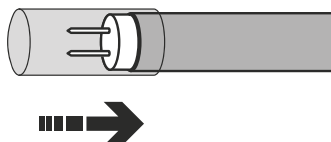

5

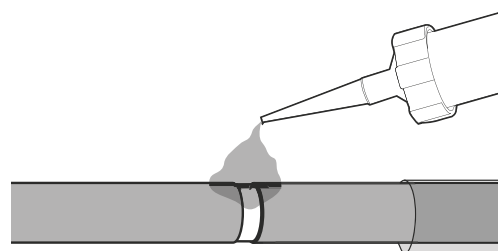
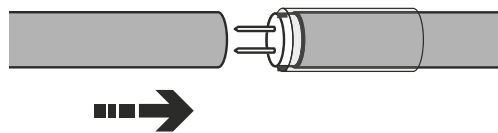

6

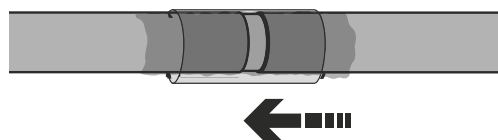

7

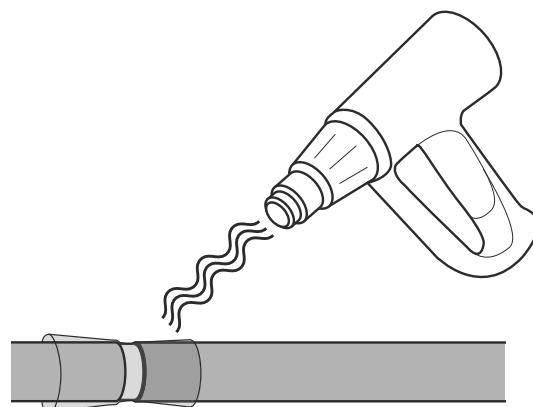

8



9

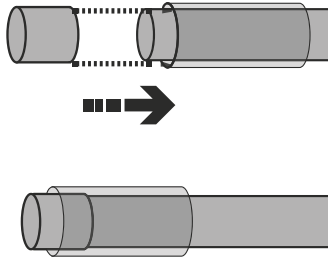

10

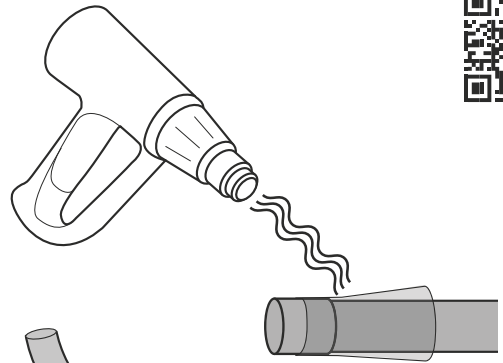

11



12

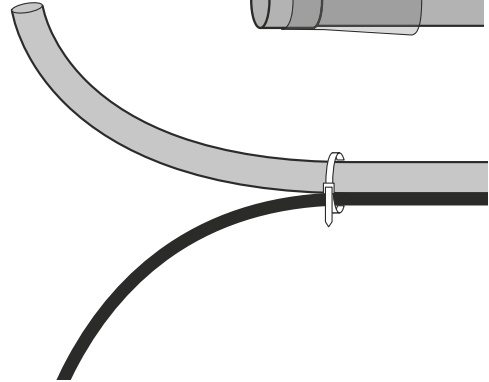

**FIG.1** Localice el tramo de hilo a reparar y elimínelo.

**FIG.2** Corte un tramo de hilo nuevo y selle los orificios internos de ambos extremos con 2 o 3cm de silicona.

**FIG.3** Inserte un conector introduciendo las patillas metálicas a través de los orificios de los cables metálicos del interior del hilo.

**FIG.4** Introduzca el termorretráctil por uno de los extremos del hilo para su posterior sellado.

**FIG.5** Proceda a unir los dos extremos del hilo mediante el conector rellenando el orificio con 2cm de silicona.

**Una vez unidos los dos extremos aplique y extienda silicona sobre la unión y parte del hilo.**

**FIG.6** Coloque el termorretráctil sobre la junta de los dos tramos de hilo.

**FIG.7/8** Selle la junta calentando el termorretráctil.

**FIG.9/10/11** Repita este proceso en los extremos de los tramos a sustituir colocando un tapón para rematar los tramos finales del hilo. No olvide rellenar los orificios con silicona.

**FIG.12** Fije los tramos de hilo a la estructura del motivo.

**FIG.1** Locate the section to repair.

**FIG. 2** Cut a piece of new wire and seal the ends with silicone.

**FIG.3** Insert a new connector metal entering through wire pin inside the holes of the internal wires.

**FIG.4** Enter a shrink in the wire's side for its subsequent sealing.

**FIG.5** Proceed to join the two ends of the wire through the connector. **Then extend and apply silicone on the union and part of the wire.**

**FIG. 6** Introduce the shrink on the joint of the two wire's sections.

**FIG.7/8** Seal the seam by heating the shrinkable.

**FIG.9/10/11** Repeat this process at the ends of every sections to be replaced.

**FIG.12** Set the new sections to the metallic structure.

**FIG.1** Localisez la section de fil de réparation.

**FIG.2** Coupez un morceau de fil de fer. Sceller les extrémités avec du silicone.

**FIG.3** Insérer un nouveau connecteur métal entrant dans les trous des fils métalliques dans l'axe du fil.

**FIG.4** Entrez un psy par une extrémité du fil pour la fermeture ultérieure.

**FIG.5** Passez à joindre les deux extrémités du fil à travers le connecteur.

**Une fois que les deux extrémités ensemble et étendre appliquer silicone sur l'union et une partie du fil.**

**FIG.6** Introduire le psy sur le plateau des deux sections de fil.

**FIG.7/8** Sceller le joint en chauffant le psy.

**FIG.9/10/11** Répétez ce processus sur les extrémités des sections à remplacer.

**FIG.12** Set mèches la structure du moyen.

**FIG.1** Localize a seção de roscas.

**FIG.2** Corte um pedaço de arame e selar as extremidades com silicone.

**FIG.3** Inserir um novo conector de metal que entra através dos orificios dos fios de metal do pino de arame. Uma extremidade do fio para vedação posterior.

**FIG.5** Unir as duas extremidades do fio através do conector. **Uma vez que as duas pontas e estender aplicar silicone na união e parte da discussão.**

**FIG.6** Introduzir o termorretráctil no quadro das duas seções de fio.

**FIG. 7/8** Selar a costura por aquecimento do termorretráctil.

**FIG.9/10/11** Repita este processo as extremidades das seções.

**FIG. 11/12** Set vagueia a estrutura do fundamento.

## Ñ/ Recomendación

Se recomienda la revisión de todas las conexiones y empalmes de los motivos y productos de Navidad antes y después de su puesta en funcionamiento en cada campaña para evitar la dilatación de juntas y condensaciones.

Se recomienda NO dejar expuesto a la intemperie el hilo luminoso más de un año para evitar su degradación por los rayos ultravioletas del sol.

Es recomendable la desinstalación del producto al finalizar cada campaña.

## E/ Recommendation

Reviewing all connections and splices motives and Christmas products is recommended before and after their operation in each campaign to prevent condensation and expansion joints.

It is recommended NOT expose to weather the bright thread over a year to prevent degradation by ultraviolet rays.

We recommend uninstalling the product at the end of each campaign.

## F/ Recommandatio

Revoir toutes les connexions et raccords de motifs et de produits de Noël est recommandé avant et après leur opération dans chaque campagne pour éviter la condensation et les joints de dilatation.

Il est recommandé de ne pas exposer aux intempéries le fil lumineux plus d'un an pour éviter degradation par les rayons ultraviolets.

Nous recommandons de désinstaller le produit à la fin de chaque campagne.

## P/ Recomendação

Rever todas as conexões e emendas motivos e produtos de Natal é recomendada antes e após a sua operação em cada campanha para evitar a condensação e expansão articulações.

Recomenda-se não expor para enfrentar a linha brilhante ao longo de um ano para evitar degradation pelos raios ultravioleta.

Recomendamos desinstalar o produto, no final de cada campanha.

# Reparación cable alimentación

Repair of the power cable

Réparation du câble d'alimentation

Reparação do cabo de alimentação

1



2

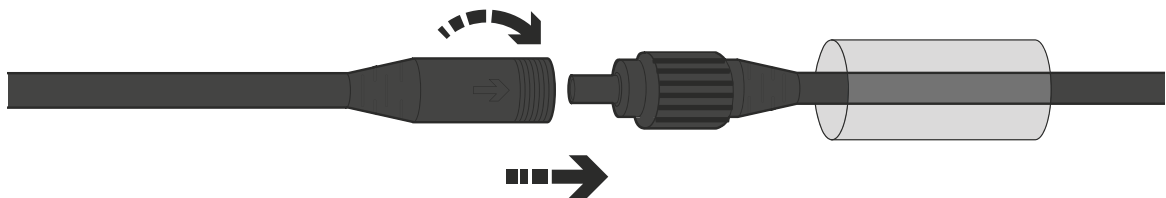

3

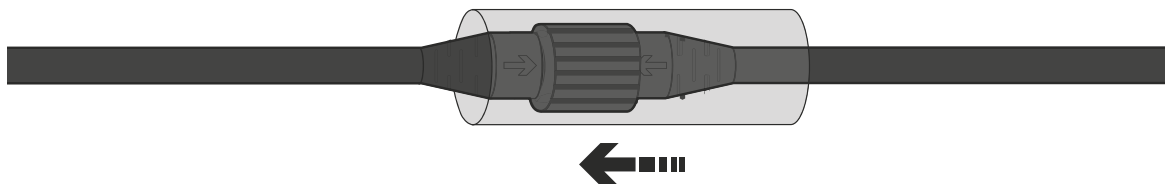

4

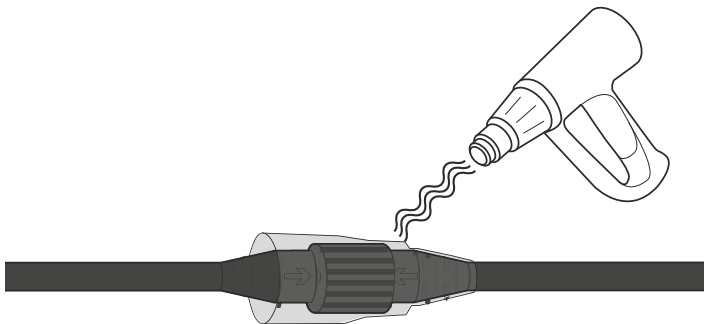

5

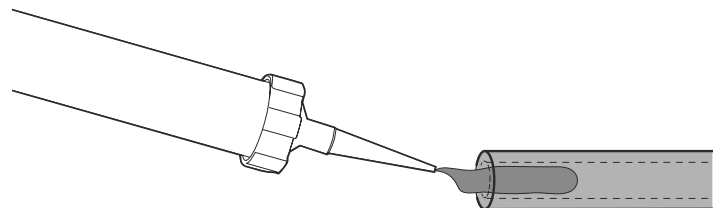



6

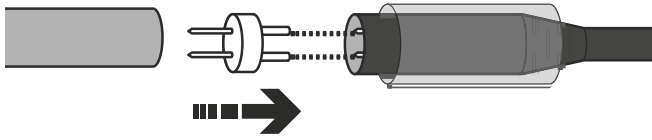

**Ñ/ ASEGÚRESE DE QUE LA POLARIDAD Y EL SENTIDO DE LA CORRIENTE SON LOS CORRECTOS.**

**E/ MAKE SURE THAT THE POLARITY AND THE POWER DIRECTION ARE CORRECT.**

**F/ ASSUREZ-VOUS QUE LA POLARITÉ ET LA DIRECTION DE LA PUISSANCE SONT CORRECT.**

**P/ CERTIFIQUE QUE A POLARIDADE E A DIREÇÃO DA CORRENTE SÃO CORRETAS.**



7

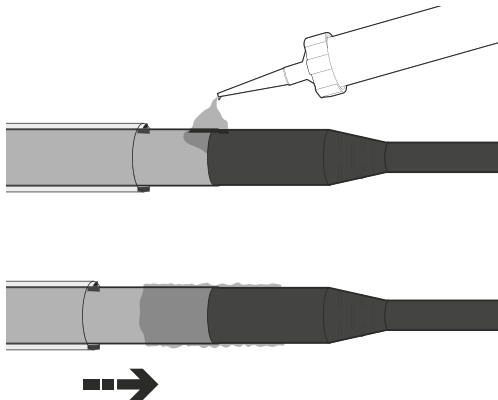

**FIG.1** Proceda a unir el cable de alimentación o en el empalme estanco insertando previamente el termorretráctil en uno de los dos elementos.  
**FIG.2** Conecte las clavijas del cable de alimentación y el empalme estanco, roscando la tapa posteriormente.  
**FIG.3** Coloque el termorretráctil sobre la unión de los dos elementos.  
**FIG.4** Caliente el termorretráctil para sellar la junta.  
**FIG.5** Rellene los orificios internos del extremo del hilo con 2 o 3cm de silicona.  
**FIG.6** Proceda realizar la unión entre cable de alimentación e hilo insertando el conector adecuado entre ambos elementos. Previamente debe introducirse un termorretráctil para su posterior sellado.  
**FIG.7 Una vez unidos los dos extremos aplique y extienda silicona sobre la unión y parte del hilo.**  
**FIG.8** Coloque el termorretráctil sobre la unión de los elementos y aplique calor para su correcto sellado.

**FIG.1** Proceed to attach the power cable or by inserting the previously sealed shrink splice in one of the two elements.  
**FIG.2** Connect the power cord plugs and tight fitting, screwing the lid later.  
**FIG.3** Place the heat shrink over the joint of the two elements.  
**FIG.4** Heat shrink to seal the joint.  
**FIG.5** Seal the ends with silicone.  
**FIG.6** Proceed to perform the union between power cord and thread inserting the appropriate connector between the two. Formerly must enter a shrink for sealing later.  
**FIG.7 Then extend and apply silicone on the union and part of the wire.**  
**FIG.8** Place the shrink over the joint elements and apply heat for proper sealing.

8

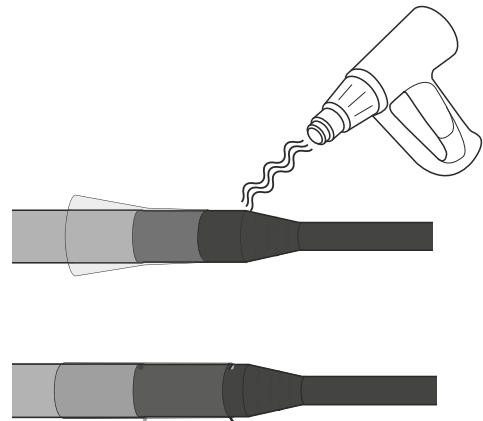

**FIG.1** Procéder à brancher le câble d'alimentation ou par l'insertion, jonction rétractable déjà scellé dans l'un des deux éléments.  
**FIG.2** Branchez les fiches du cordon d'alimentation et bien ajusté, de visser le couvercle plus tard.  
**FIG.3** Placez le rétrécissement de la chaleur sur le joint des deux éléments.  
**FIG.4** Thermorétractables l'étanchéité du joint.  
**FIG.5** Sceller le extrémité avec du silicone.  
**FIG.6** Passez à effectuer l'union entre le cordon d'alimentation et du fil de brancher le connecteur approprié entre les deux. (Anciennement doit entrer un psy pour fermer ultérieurement.  
**FIG.7** Une fois que les deux extrémités ensemble et étendre appliquer silicone sur l'union et une partie du fil.  
**FIG.8** Placez le rétrécissement de la chaleur sur les éléments communs et appliquer de la chaleur pour une bonne étanchéité.

**FIG.1** Continuar para prender o cabo de energia ou por inserção da emenda de retracção previamente seladas em um dos dois elementos.  
**FIG.2** Ligue as fichas do cabo de alimentação e apertadas, enroscando a tampa posterior.  
**FIG.3** Coloque o calor encolher sobre a articulação dos dois elementos.  
**FIG.4** Dissipadores de calor para selar a junta.  
**FIG.5** Selar a extremidade com silicone.  
**FIG.6** Continuar para realizar a união entre o cabo de alimentação e de inserir o fio de ligação adequada entre os dois. Anteriormente deve digitar um termorretráctil para selar mais tarde.  
**FIG.7** Uma vez que as duas pontas e estender aplicar silicone na união e parte da discussão.  
**FIG.7/8** Coloque o calor encolher ao longo dos elementos comuns e aplicar calor para vedação adequada.

## Ñ/ Recomendación

Se recomienda la revisión de todas las conexiones y empalmes de los motivos y productos de Navidad antes y después de su puesta en funcionamiento en cada campaña para evitar la dilatación de juntas y condensaciones.

Se recomienda NO dejar expuesto a la intemperie el hilo luminoso más de un año para evitar su degradación por los rayos ultravioletas del sol.

Es recomendable la desinstalación del producto al finalizar cada campaña.

## E/ Recommendation

Reviewing all connections and splices motives and Christmas products is recommended before and after their operation in each campaign to prevent condensation and expansion joints.

It is recommended NOT expose to weather the bright thread over a year to prevent degradación by ultraviolet rays.

We recommend uninstalling the product at the end of each campaign.

## F/ Recommendation

Revoir toutes les connexions et raccords de motifs et de produits de Noël est recommandé avant et après leur opération dans chaque campagne pour éviter la condensation et les joints de dilatation.

Il est recommandé de ne pas exposer aux intempéries le fil lumineux plus d'un an pour éviter degradación par les rayons ultraviolets.

Nous recommandons de désinstaller le produit à la fin de chaque campagne.

## P/ Recomendação

Rever todas as conexões e emendas motivos e produtos de Natal é recomendada antes e após a sua operação em cada campanha para evitar a condensação e expansão articulações.

Recomenda-se não expor para enfrentar a linha brilhante ao longo de um ano para evitar degradación pelos raios ultravioleta.

Recomendamos desinstalar o produto, no final de cada campanha.

## Certificaciones

Certifications  
Certifications  
Certificações



SGS ISO 9001



SGS ISO 14001



SGS ISO 45001



SGS ISO 50001

## Condiciones de Uso

Terms of use  
Condition d'utilisation  
Condições de uso



## Condiciones de Garantía

Warranty Conditions  
Conditions de garantie  
Condições de garantia



























## Condiciones de Venta

Terms of sale  
Conditions de vente  
Condições de venda













|  | ESPAÑOL (Ñ)                        | ENGLISH (E)                       | FRANÇAIS (F)                         | PORTUGUÊS (P)                      |
|--|------------------------------------|-----------------------------------|--------------------------------------|------------------------------------|
|    | Código                             | Code                              | Code                                 | Código                             |
|    | Código izquierda                   | Left code                         | Code gauche                          | Código esquerdo                    |
|    | Código derecha                     | Right code                        | Code droite                          | Código certo                       |
| <b>W</b>   | Consumo total (W)                  | Consumption (W)                   | Consommation (W)                     | Consumo (W)                        |
|    | Modelo                             | Model                             | Modèle                               | Modelo                             |
|    | Tensión (V)                        | Voltage (V)                       | Tension D` Alimentation (V)          | Tensão (V)                         |
| <b>Hz</b>  | Frecuencia (Hz)                    | Frequency (Hz)                    | Fréquence (Hz)                       | Frequência (Hz)                    |
|    | Clase I<br>Aislamiento eléctrico   | Class I<br>Electrical isolation   | Classe I<br>Isolation électrique     | Clase I<br>Isolamento elétrico     |
|    | Clase II<br>Aislamiento eléctrico  | Class II<br>Electrical isolation  | Classe II<br>Isolation électrique    | Clase II<br>Isolamento elétrico    |
|    | Clase III<br>Aislamiento eléctrico | Class III<br>Electrical isolation | Classe III<br>Isolation électrique   | Clase III<br>Isolamento elétrico   |
|    | IP<br>Índice de estanqueidad       | IP<br>Sealing rating              | IP<br>Indice d`etanchéité            | IP<br>Índice de selagem            |
|  | Temperatura<br>de funcionamiento   | Operating temperature             | Température de service               | Temperatura de trabalho            |
|  | Canal/Vías                         | Canal/Ways                        | Canal/Voies                          | Canal/Maneiras                     |
|  | Ángulo de apertura                 | Opening angle                     | Angle d`ouverture                    | Ângulo de abertura                 |
|  | Número de led                      | LED number                        | Nombre de led                        | Número de led                      |
|  | Fuente de luz                      | Light source                      | Source de lumière                    | Fonte de luz                       |
|  | Horas por carga                    | Hours per charge                  | Heures par charge                    | Horas por carga                    |
|  | Color cuerpo                       | Body colour                       | Couleur du corps                     | Cor do corpo                       |
|  | Color led                          | Led colour                        | Couleur led                          | Cor led                            |
|  | Color contorno (1, 2, 3,...)       | Contour colour (1, 2, 3,...)      | Couleur de contour (1, 2, 3,...)     | Cor de contorno (1, 2, 3,...)      |
|  | Color relleno (1, 2, 3,...)        | Colour fill (1, 2, 3,...)         | Remplissage de couleur (1, 2, 3,...) | Preenchimento de cor (1, 2, 3,...) |
|  | Peso                               | Weight                            | Poids                                | Peso                               |
|  | Longitud                           | Lenght                            | Longueur                             | Comprimento                        |
|  | Dimensiones                        | Measures                          | Dimensions                           | Dimensão                           |
|  | Cuerpo                             | Body                              | Corps                                | Corpo                              |

|  | ESPAÑOL (Ñ)                       | ENGLISH (E)                 | FRANÇAIS (F)                       | PORTUGUÊS (P)                      |
|--|-----------------------------------|-----------------------------|------------------------------------|------------------------------------|
|   | Marco                             | Frame                       | Cadre                              | Quadro                             |
|    | Consumo/Corte                     | Consumption/Cut             | Consommation/Couper                | Consumo/Corte                      |
|    | Corte tira                        | Strip cut                   | Coupe bande                        | Corte tira                         |
|    | Tapa inicio/Tapa final            | Start cover / End cover     | Capot de début / Capot de fin      | Tampa inicial / Tampa final        |
|   | Unión                             | Union                       | Union                              | União                              |
|   | Rollo                             | Roll                        | Rouleau                            | Rolo                               |
|    | Consumo/Segmento                  | Consumption/Segment         | Consumption/Segment                | Consumo/Segmento                   |
|    | Segmento                          | Segment                     | Segment                            | Segmento                           |
|    | Número de segmentos               | Number of segments          | Nombre de segments                 | Número de segmentos                |
|    | Número de led/Segmento            | LED number/Segment          | Nombre de led/Segment              | Número de led/Segmento             |
|    | Consumo/Portalámparas             | Consumption/Lamp holder     | Consommation/Douille               | Consumo/Lâmpada                    |
|  | Portalámparas                     | Lamp holder                 | Douille                            | Lâmpada                            |
|  | Número de tiras                   | Number of strips            | Nombre de bandes                   | Número de tiras                    |
|  | Led/Tiras                         | Led/Strips                  | Led/Bandes                         | Led/Tiras                          |
|  | Producto para suspender           | Product to suspend          | Produit à suspendre                | Produto para suspender             |
|  | Embalaje                          | Packaging                   | Emballage                          | Embalagem                          |
|  | Unidad/Embalaje                   | Unit/Packaging              | Unité/Emballage                    | Unidade/Embalagem                  |
|  | Diámetro                          | Diameter                    | Diamètre                           | Diâmetro                           |
|  | Datos panel solar                 | Solar panel data            | Données de panneau solaire         | Dados do painel solar              |
|  | Datos batería                     | Battery data                | Données de la batterie             | Dados da bateria                   |
|  | Número de bolas                   | Number of balls             | Nombre de balles                   | Número de bolas                    |
|  | Empalmable                        | Linkable                    | Empalmable                         | Junção                             |
|  | NO Empalmable                     | NO Empalmable               | NO Empalmable                      | NO Empalmable                      |
|  | Cable alimentación<br>NO incluido | Power cable<br>NOT included | Câble d'alimentation<br>NON inclus | Cabo de alimentação<br>NÃO incluso |
|  | Cable alimentación<br>incluido    | Power cable<br>included     | Câble d'alimentation<br>inclus     | Cabo de alimentação<br>incluso     |



|  | ESPAÑOL (Ñ)                           | ENGLISH (E)                  | FRANÇAIS (F)                 | PORTUGUÊS (P)                    |
|--|---------------------------------------|------------------------------|------------------------------|----------------------------------|
|    | Control                               | Control                      | Contrôle                     | Controla                         |
|    | Controlador<br>NO incluido            | Controller<br>NOT included   | Contrôleur<br>NON inclus     | Controlador<br>NÃO incluso       |
|    | Controlador<br>incluido               | Controller<br>included       | Contrôleur<br>inclus         | Controlador<br>incluso           |
|    | Transformador<br>NO incluido          | Transformer<br>NOT included  | Transformateur<br>NON inclus | Transformador<br>NÃO incluso     |
|    | Transformador<br>incluido             | Transformer<br>included      | Transformateur<br>inclus     | Transformador<br>incluso         |
|    | Adaptador<br>NO incluido              | Adapter<br>NOT included      | Adaptateur<br>NON inclus     | Adaptador<br>NÃO incluso         |
|    | Adaptador<br>incluido                 | Adapter<br>included          | Adaptateur<br>inclus         | Adaptador<br>incluso             |
|    | Rectificador<br>NO incluido           | Rectifier<br>NOT included    | Redresseur<br>NON inclus     | Retificador<br>NÃO incluso       |
|    | Rectificador<br>incluido              | Rectifier<br>included        | Redresseur<br>inclus         | Retificador<br>incluso           |
|    | Fuente de alimentación<br>NO incluida | Power supply<br>NOT included | Alimentation<br>NON inclus   | Fonte de energia<br>NÃO incluído |
|    | Extensión<br>NO incluido              | Extension<br>NOT included    | Extension<br>NON inclus      | Extensão<br>NÃO incluso          |
|  | Extensión<br>incluido                 | Extension<br>included        | Extension<br>inclus          | Extensão<br>incluso              |
|  | Accesorios                            | Accessories                  | Accessoires                  | Acessórios                       |
|  | Instalación rápida                    | Quick Install                | Installation rapide          | Instalação rápida                |
|  | Para conos de Xm                      | For Xm cones                 | Pour les cônes Xm            | Para conos Xm                    |
|  | Componentes                           | Components                   | Composants                   | Componentes                      |
|  | Video demostrativo                    | Demonstration video          | Vidéo de démonstration       | Vídeo de demonstração            |
|  | Ficha Técnica                         | Data Sheet                   | Fiche Technique              | Ficha Técnica                    |
|  | Motivo Fachada                        | Motifs Facade                | Motifs Façade                | Motivo Fachada                   |
|  | Motivo Farola                         | Motifs Streetlight           | Motifs Lampadaire            | Motivo Poste de luz              |
|  | Motivo Calle                          | Motifs Street                | Motifs Rue                   | Motivo Rua                       |
|  | Motivo de interior                    | Motifs inside                | Motifs à l'intérieur         | Motivo dentro                    |
| <b>3D</b>  | Motivo 3D                             | Motifs 3D                    | Motifs 3D                    | Motivo 3D                        |
|  | Motivo Mini                           | Motifs Mini                  | Motifs Mini                  | Motivo Mini                      |

| LED   | MICRO  | CABLE   | PVC   | ESPAÑOL (Ñ)            | ENGLISH (E)            | FRANÇAIS (F)          | PORTUGUÊS (P)          |
|---|--|---|---|------------------------|------------------------|-----------------------|------------------------|
| -   | -  |    |    | Blanco                 | White                  | Blanc                 | Branco                 |
| -   | -  |    | -   | Negro                  | Black                  | Noir                  | Preto                  |
|    | -  | -   | -   | Diamond (10.000K)      | Diamond (10.000K)      | Diamond (10.000K)     | Diamond (10.000K)      |
|    | -  | -   | -   | Blanco frío (8.000K)   | Cool white (8.000K)    | Blanc froid (8.000K)  | Branco frio (8.000K)   |
|    | -  | -   | -   | Blanco cálido (2.500K) | Warm white (2.500K)    | Blanc chaud (2.500K)  | Branco quente (2.500K) |
|    | -  | -   | -   | Blanco neutro (4.000K) | Neutral White (4.000K) | Blanc neutre (4.000K) | Branco neutro (4.000K) |
| -   |   |    |    | Transparente           | Transparent            | Transparent           | Transparente           |
|    |   |    |    | Azul                   | Blue                   | Bleu                  | Azul                   |
|    | -  | -   | -   | Verde manzana          | Apple green            | Vert pomme            | Maçã verde             |
|    |   |    |    | Verde claro            | Light green            | Vert clair            | Luz verde              |
| -   | -  |    | -   | Verde oscuro           | Dark green             | Vert foncé            | Verde oscuro           |
|    |   |    |    | Amarillo               | Yellow                 | Jaune                 | Amarelo                |
|    | -  | -   | -   | Amarillo intenso       | Deep yellow            | Jaune profond         | Amarelo escuro         |
|    |   |    |    | Rojo                   | Red                    | Rouge                 | Vermelho               |
|    | -  |    |    | Rosa                   | Pink                   | Rose                  | Rosa                   |
| -   |  | -   |   | Fucsia                 | Fuchsia                | Fuchsia               | Fúcsia                 |
|  | -  |  |  | Púrpura                | Purple                 | Pourpre               | Roxo                   |
|  | -  |  |  | Naranja                | Orange                 | Orange                | Laranja                |
|  | -  |  | -   | Dorado (2.000K)        | Golden (2.000K)        | D'or (2.000K)         | Dourado (2.000K)       |
|  | -  | -   | -   | Dual                   | Dual                   | Double                | Duplo                  |
|  | -  | -   | -   | RGB                    | RGB                    | RVB                   | RGB                    |
|  | -  | -   | -   | RGBW                   | RGBW                   | RVBW                  | RGBW                   |
|  | -  | -   | -   | RGBWW                  | RGBWW                  | RVBWW                 | RGBWW                  |
|  | -  | -   | -   | CW-WW                  | CW-WW                  | CW-WW                 | CW-WW                  |
|  | -  | -   | -   | Multicolor             | Multicolored           | Multicolore           | Multicolorido          |
|  | -  | -   | -   | Flashing               | Flashing               | Clignotant            | Piscando               |
|  | -  | -   | -   | ALL Flashing           | ALL Flashing           | Tous Clignotant       | Todos Piscando         |
|  | -  | -   | -   | Sparkles               | Sparkles               | Sparkles              | Sparkles               |

---

## GRUPO PRILUX ILUMINACIÓN S.L.U.

---

### SEDE CENTRAL

---

C/ Río Jarama nº 149.45007, Toledo (Spain).  
Tel.: 925 23 38 12 / Fax: 925 23 38 80

---

### DELEGACIÓN NORESTE

---

Carretera BV - 2249 Km 8  
08791, Sant Llorenç d'Hortons, Barcelona (Spain).

**Prilux eConcept** Tel.: (+34) 93 891 37 24

**Grupo Prilux Iluminación S.L.U** Tel: (+34) 93 719 23 29

---

[www.priluxeconcept.com](http://www.priluxeconcept.com)

---

---

## DISEÑO GRÁFICO

---

Departamento de Marketing

---

Pueden aparecer variaciones con respecto al color original debido a causas técnicas de la impresión.

Este catálogo actualiza los valores y características de las mismas luminarias que aparezcan en anteriores catálogos.

Los datos incluidos en este catálogo son correctos salvo error tipográfico.

Grupo Prilux Iluminación S.L.U. se reserva el derecho a cualquier modificación del producto sin previo aviso.

---

Web



**Tarifa**  
Price list  
Liste de prix  
Lista de preços



